

## DENTAL INSTRUMENTS CATALOG



### DETAILS

- Dental Instruments
- Orthodontic Tools
- Implants Catalogue

## ABOUT US



Welcome to **DeMaanz Industries**, a leading manufacturing & exporting company dealing in Medical Instruments such as Orthopedic Instruments, Dental Instruments & Neuro instruments.

The company was established in year 2000 and since the inception of the company, quality of work, retention of customer satisfaction, skilled craftsmanship in all our products and contemporary innovation have led our company achieve a benchmark in our product's quality and making difference towards our services at the same time.

The company enjoys a strong reputation in manufacturing premium quality products meeting all international standards. Besides this, we also adhere with prescribed rules for Child Labor following ILO rules, monitoring and implementing Health & Safety regulations, Environmental issues and complying with social compliance responsibility.

All our skilled force is backed by our research and development department that always looks through the innovative ideas, researching on improving quality standards and certain measurements to finally produce products at optimum quality.

In the end, I reiterate my words ensuring all our existing and potential buyers for providing them best possible service, in time deliveries, and product quotes meeting their budget lines and at the same time enjoying an opportunity towards best deals of premium quality products.

I warmly welcome all incoming inquiries concerning our products, quality standards or competitive quotes.

Regards,  
Muhammad Suleman  
Chief Executive

Mob: +92-300-612 6898

Land: +92-52-355 8686

- Щипцы экстракционные (английская форма)
- Daviers (Forme Anglaise)
- Zahnzangen (Englische Form)

# EXTRACTING FORCEPS

- Щипці екстракційні (англійська форма)
- Forceps de Extracción (Forme Inglesa)
- استخراج الملقط (نمط اللغة الإنجليزية)



**DE-013**  
Fig. 01  
upper centrals and canines

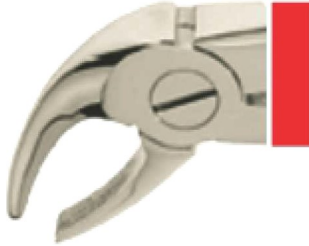

**DE-014**  
Fig. 04  
Lower incisors and Canines



**DE-015**  
Fig. 08  
Lower Bicuspids



**DE-016**  
Fig. 17  
Upper right molars



**DE-017**  
Fig. 73  
Lower molars



**DE-018**  
Fig. 21  
Lower molars



**DE-019**  
Fig. 02  
upper incisors and canines



**DE-020**  
Fig. 07  
Lower Canines and bicuspids



**DE-021**  
Fig. 13  
Lower Canines and bicuspids



**DE-022**  
Fig. 18  
Upper Left Molars



**DE-023**  
Fig. 22  
Lower molars - Untere Molaren



**DE-024**  
Fig. 75  
Lower canines and bicuspids

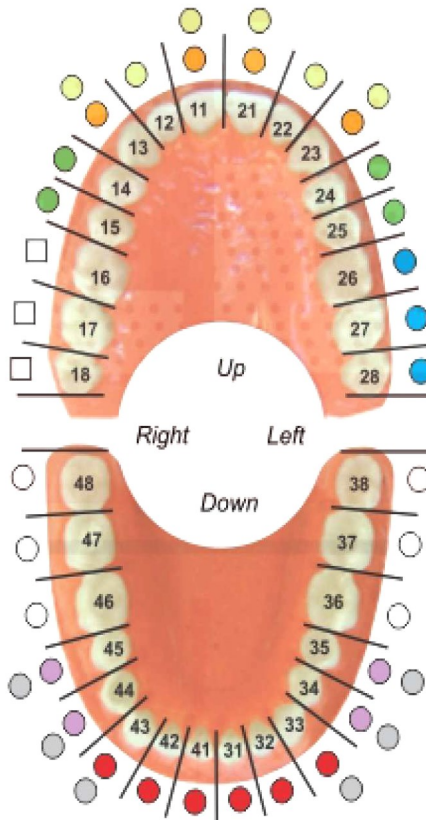

# EXTRACTING FORCEPS(ENGLISH PATTERN)

- Щипцы экстракционные (английская форма)
- Daviers (Forme Anglaise)
- Zahnzangen (Englische Form)
- Щипці екстракційні (англійська форма)
- Forceps de Extracción (Forme Inglesa)
- استخراج الملقط (نمط اللغة الإنجليزية)



**DE-001**  
Fig. 23  
Syndesmotome lower roots



**DE-002**  
Fig. 24  
Syndesmotome upper model



**DE-003**  
Fig. 25  
Syndesmotome Lower model forceps



**DE-004**  
Fig. 79  
Lower Wisdoms



**DE-005**  
Fig. 60  
Upper roots, extra slim jaws



**DE-006**  
Fig. 62  
Upper roots, extra slim jaws



**DE-007**  
Fig. 74  
Upper roots and incisors



**DE-008**  
Fig. 33  
Lower Roots



**DE-009**  
Fig. 51  
Upper Roots



**DE-010**  
Fig. 61  
upper Roots, short,  
extra slim jaws



**DE-011**  
Fig. 67  
upper wisdoms,  
either sides



**DE-012**  
Fig. 86  
lower molars decayed or  
with broken down crown

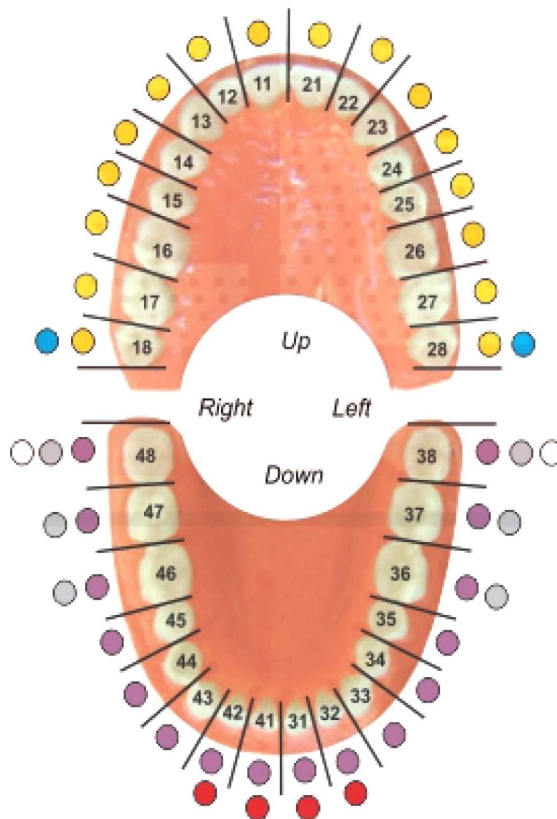

- щипцы экстракционные (английская форма)
- Daviers (Forme Anglaise)
- Zahnzangen (Englische Form)

# EXTRACTING FORCEPS (ENGLISH PATTERN)

- Щипці екстракційні (англійська форма)
- Forceps de Extracción (Forme Inglesa)
- استخراج الملقط (نمط اللغة الإنجليزية)



**DE-013**  
Fig. 01  
upper centrals and canines



**DE-014**  
Fig. 04  
Lower incisors and Canines



**DE-015**  
Fig. 08  
Lower Bicuspids



**DE-016**  
Fig. 17  
Upper right molars



**DE-017**  
Fig. 73  
Lower molars



**DE-018**  
Fig. 21  
Lower molars



**DE-019**  
Fig. 02  
upper incisors and canines



**DE-020**  
Fig. 07  
Lower Canines and bicuspids



**DE-021**  
Fig. 13  
Lower Canines and bicuspids



**DE-022**  
Fig. 18  
Upper Left Molars



**DE-023**  
Fig. 22  
Lower molars - Untere Molaren



**DE-024**  
Fig. 75  
Lower canines and bicuspids

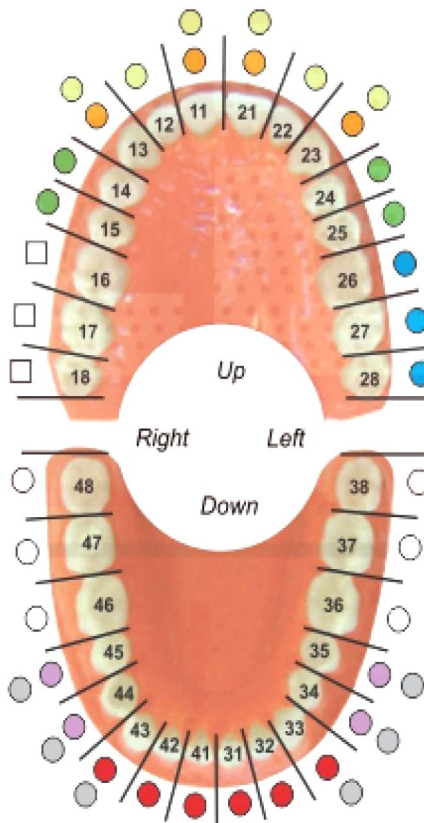

# EXTRACTING FORCEPS (ENGLISH PATTERN)

- Щипцы экстракционные (английская форма)
- Daviers (Forme Anglaise)
- Zahnzangen (Englische Form)
- Щипці екстракційні (англійська форма)
- Forceps de Extracción (Forme Inglesa)
- استخراج الملقط (نمط اللغة الإنجليزية)

## Apical Set of 9 Pcs (Deep Gripe Extracting Forceps)

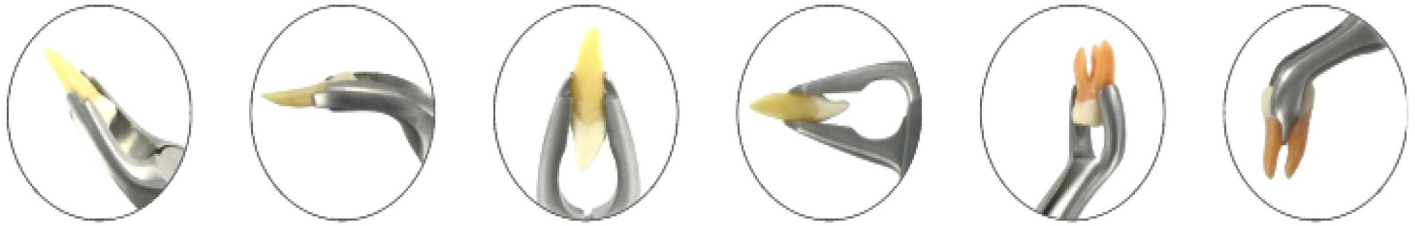

- No Fracture
- No Tissue Damage
- Extraction With Easy

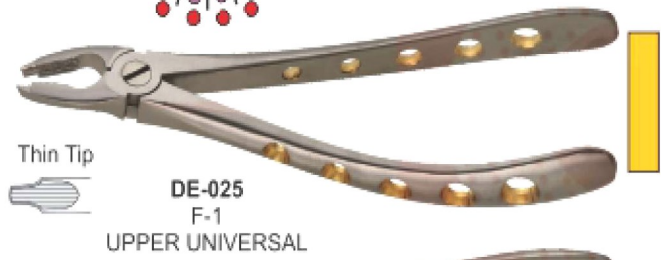
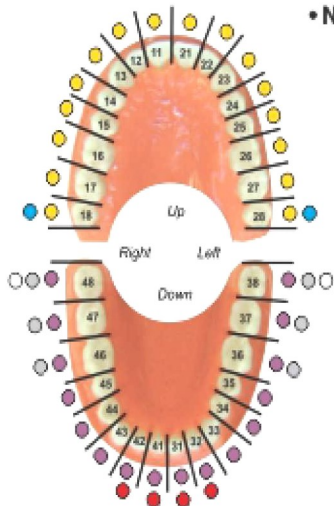

### A-TRAUMATIC EXTRACTION SET

Improved tapered beaks for complete root contact. Cross serrations for a never slip grasp. Easily enter the sub gingival.

- Щипцы экстракционные (английская форма)
- Щипцы екстракційні (англійська форма)
- Daviers (Forme Anglaise)
- Forceps de Extracción (Forme Inglesa)
- Zahnzangen (Englische Form)
- استخراج الملقط (نمط اللغة الإنجليزية)



Fig. 79A Fig. 45Z



Fig. 51Z Fig. 44Z Fig. 46



Fig. 67 Fig. 67A Fig. 79

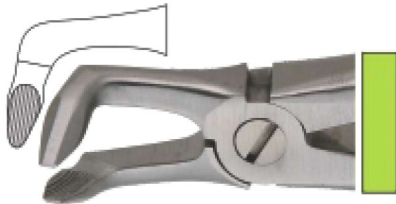

**DE-034**  
Fig. 9  
Apex Forceps Lower Universal  
Deep Root Pick



**DE-035**  
Fig. 187  
Apex Forceps Lower Root  
Deep Root Pick



**DE-036**  
Fig. 189  
Apex Forceps  
Upper Root  
Deep Root Pick



**DE-037**  
Fig. 190  
Apex Forceps Upper Root  
Deep Root Pick



**DE-038**  
Fig. 46XL  
Apex Forceps Lower Root  
Deep Root Pick

## DEEP ROOT PICK FORCEPS (Apical Set of 9)

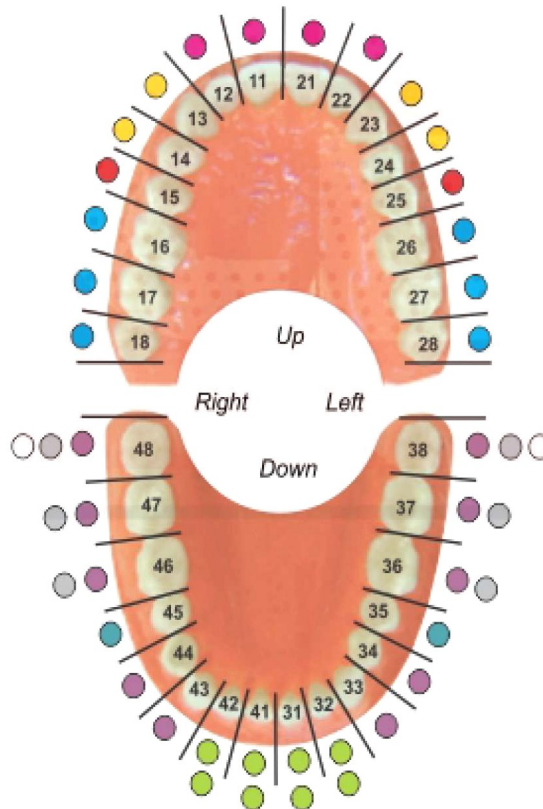

**DE-039**  
Fig. 67  
Upper Third Molars

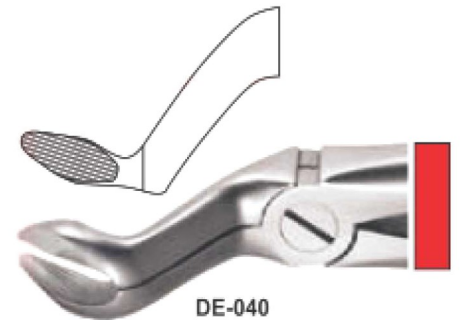

**DE-040**  
Fig. 67A  
Upper Third Molars



**DE-041**  
Fig. 79  
Lower Third Molars



**DE-042**  
Fig. 37  
Lower Root Molars

# EXTRACTING FORCEPS (ENGLISH PATTERN)

- Щипцы экстракционные (английская форма)
- Daviers (Forme Anglaise)
- Zahnzangen (Englische Form)
- Щипці екстракційні (англійська форма)
- Forceps de Extracción (Forme Inglesa)
- استخراج الملقط (نمط اللغة الإنجليزية)



**DE-043**  
Fig. 2  
upper laterals and canines



**DE-048**  
Fig. 13  
Lower Premolars/  
Bicuspids



**DE-044**  
Fig. 7  
Upper Premolars/Bicuspids



**DE-049**  
Fig. 22  
Lower Molars



**DE-045**  
Fig. 17  
Upper Molars, Right

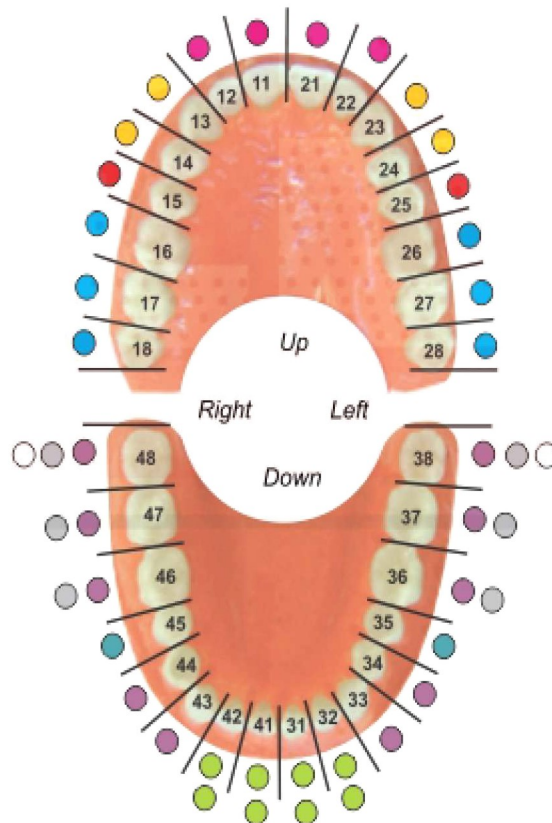

**DE-050**  
Fig. 33  
lower roots



**DE-046**  
Fig. 18  
Upper Molars, Left



**DE-051**  
Fig. 51  
upper roots



**DE-047**  
Fig. 67  
upper third molars



**DE-052**  
Fig. 79  
Lower third molars



# EXTRACTING FORCEPS (ENGLISH PATTERN)

- Щипцы экстракционные (английская форма)
- Daviers (Forme Anglaise)
- Zahnzangen (Englische Form)
- Щипці екстракційні (англійська форма)
- Forceps de Extracción (Forme Inglesa)
- استخراج الملقط (نمط اللغة الإنجليزية)

Extracting Forceps  
Set of 10 Pcs  
Detail of Pack  
Forceps  
Fig. 1  
Fig. 2  
Fig. 73  
Fig. 67  
Fig. 51A  
Fig. 74  
Fig. 51  
Fig. 17  
Fig. 7  
Fig. 13

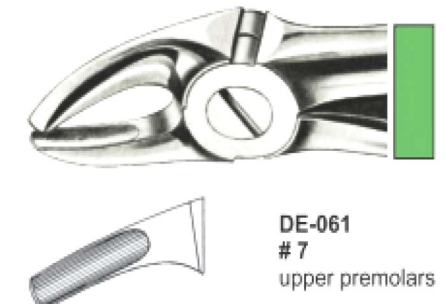
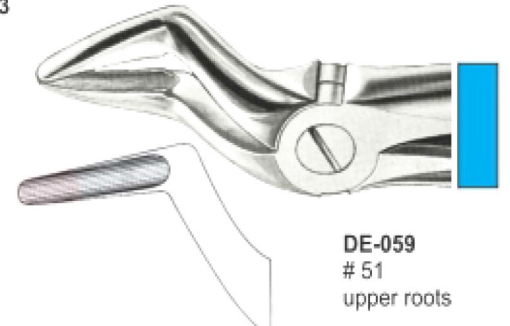
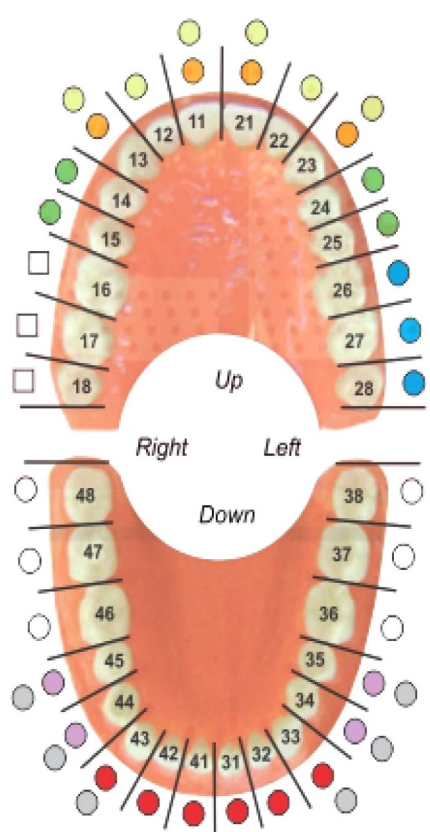
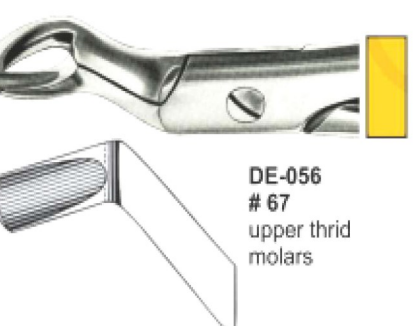
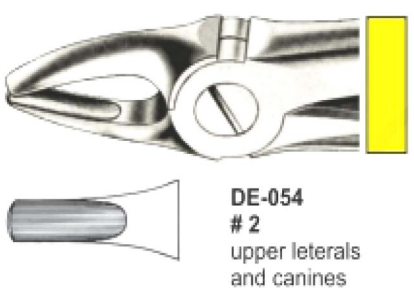

# EXTRACTING FORCEPS (ENGLISH PATTERN)

- Щипцы экстракционные (английская форма)
- Daviers (Forme Anglaise)
- Zahnzangen (Englische Form)
- Щипці екстракційні (англійська форма)
- Forceps de Extracción (Forme Inglesa)
- استخراج الملقط (نمط اللغة الإنجليزية)

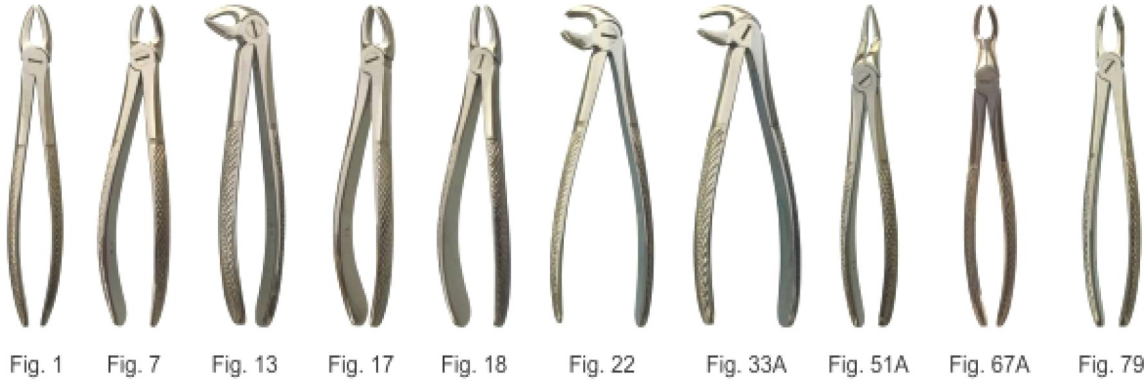

Set of 10 Pieces  
 Fig. 1  
 Fig. 7  
 Fig. 13  
 Fig. 17  
 Fig. 18  
 Fig. 22  
 Fig. 33A  
 Fig. 51A  
 Fig. 67A  
 Fig. 79



**DE-063**  
 Fig. 1  
 Upper Centrals  
 & Canines/Cuspids



**DE-064**  
 Fig. 7  
 Upper Premolars/  
 Bicuspid



**DE-065**  
 Fig. 13  
 Lower Premolars/  
 Bicuspid



**DE-066**  
 Fig. 17  
 Upper Molars,  
 Right



**DE-067**  
 Fig. 18  
 Upper Molars,  
 Left

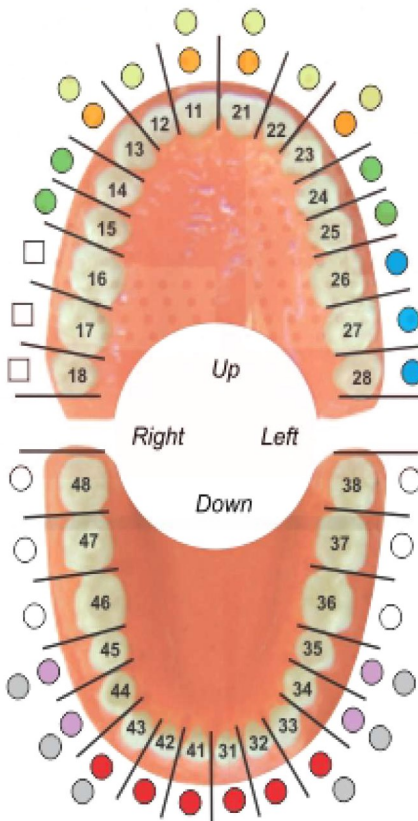

**DE-068**  
 Fig. 22  
 Lower Molars



**DE-069**  
 Fig. 33A  
 Lower Roots  
 Narrow tips



**DE-070**  
 Fig. 51A  
 Upper roots  
 narrow tips



**DE-071**  
 Fig. 67A  
 Upper third  
 molars



**DE-072**  
 Fig. 79  
 Lower third  
 molars

- Щипцы экстракционные
- Daviers
- Zahnzangen
- Щипці екстракційні
- Forceps de Extracción
- استخراج الملقط

## Pediatric Tooth Extracting Forceps Set



**DE-074**  
English Pattern Klein #51S  
Pedodontic Upper root



**DE-073**  
English Pattern Klein #137  
Pedodontic, Upper Incisors  
Spring handle



**DE-077**  
English Pattern Klein #5  
Pedodontic Lower Incisors.



**DE-075**  
English Pattern Klein #139  
Pedodontic Upper Premolars



Fig. # 01 to 07  
Set of 7 Pieces



**DE-078**  
English Pattern Klein #7  
Pedodontic Lower Roots,



**DE-076**  
English Pattern Klein #3  
Pedodontic Upper Molars  
Universal

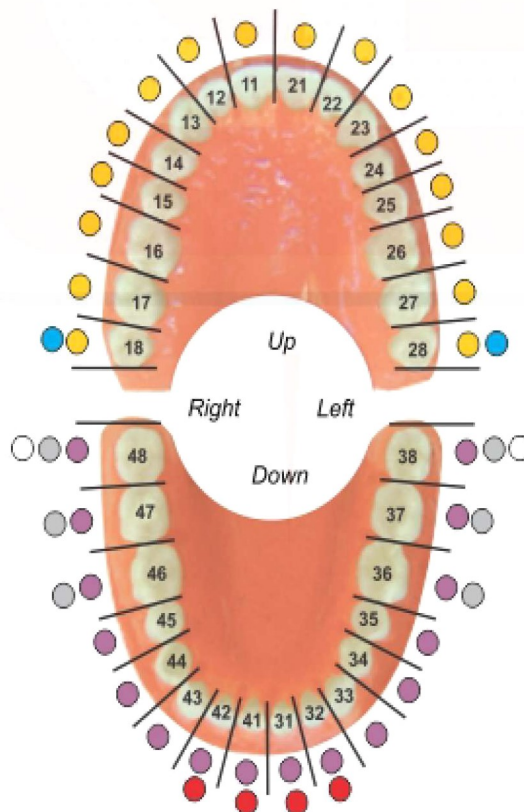

**DE-079**  
English Pattern Klein #6  
Pedodontic Lower Molars,  
Spring Handle

# EXTRACTING FORCEPS (ENGLISH PATTERN)

- Щипцы экстракционные
  - Daviers
  - Zahnzangen
- Щипці екстракційні
  - Forceps de Extracción
  - استخراج الملقظ

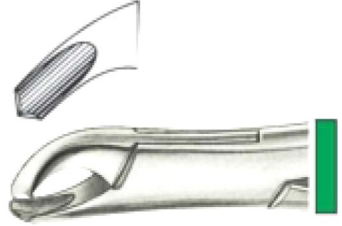

**DE-080**  
Fig. 17 SK  
Lower molars



**DE-084**  
Fig. 17S  
Lower, molars

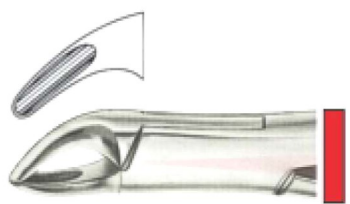

**DE-081**  
Fig. 150 SK  
Upper anteriors and roots



**DE-085**  
Fig. 18LS  
upper, molars left

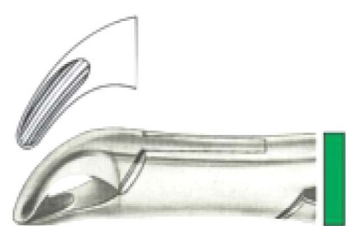

**DE-082**  
Fig. 151 SK  
lower anteriors and roots



**DE-086**  
Fig. 18RS  
upper, molars right



**DE-083**  
Fig. 90  
Upper molars, left



**DE-087**  
Fig. 65S  
upper incisors and roots



**DE-088**  
Fig. 69S  
upper and lower roots

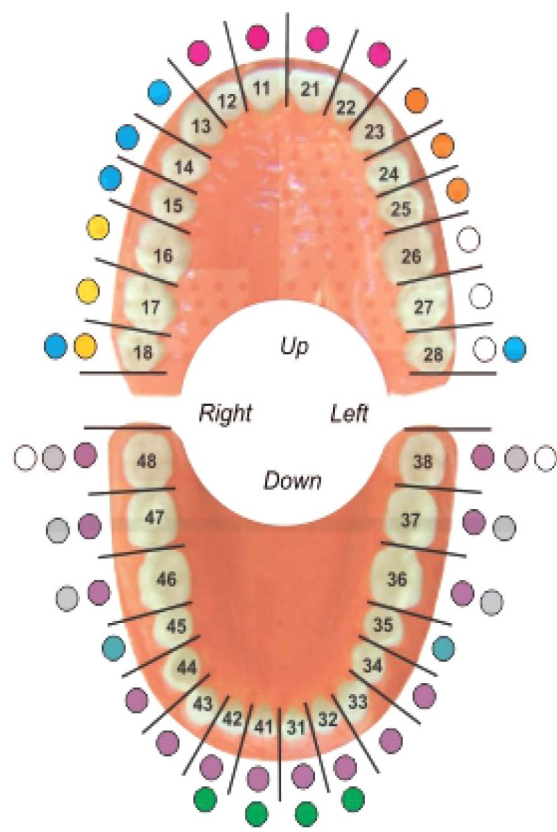

# EXTRACTING FORCEPS (AMERICAN PATTERN)

- Щипцы экстракционные (американская форма)
- Davigers - forme americane
- Fórceps de extracción - forma americana
- Щипці екстракційні (американська форма)
- Pinzeper per estrazione - forma americana
- استخراج الملقط (النمط الأمريكي)

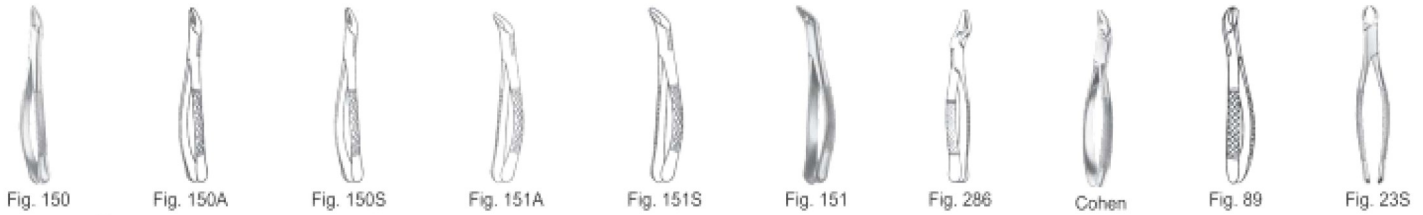

**DE-089**  
**# 150**  
Cryer upper incisors, premolars, roots



**DE-094**  
**# 151**  
Cryer lower teeth, for children

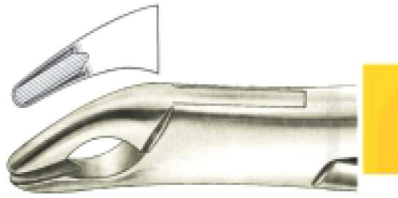

**DE-090**  
**# 150A**  
Cryer upper incisors, premolars, roots

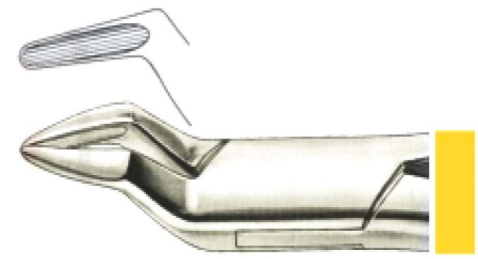

**DE-095**  
**# 286**  
upper incisors and roots



**DE-091**  
**# 150S**  
Cryer upper teeth, for children

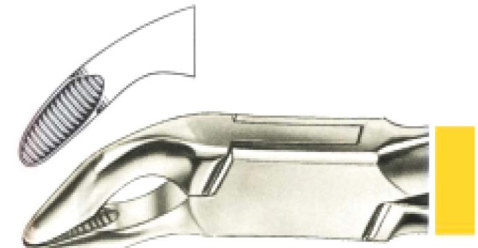
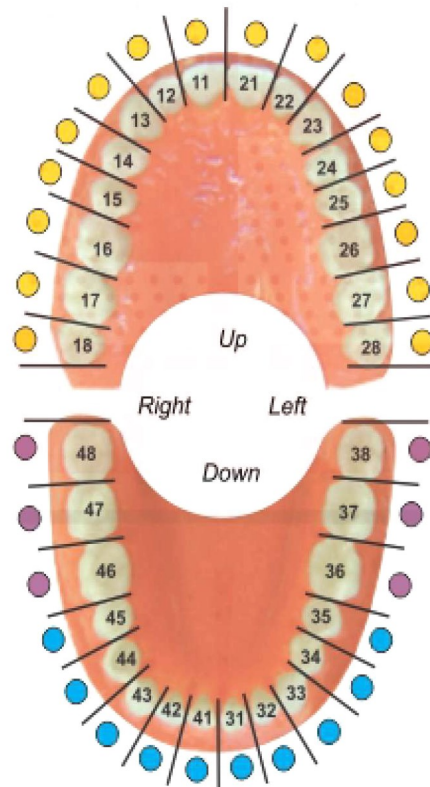

**DE-096**  
Cohen universal forceps

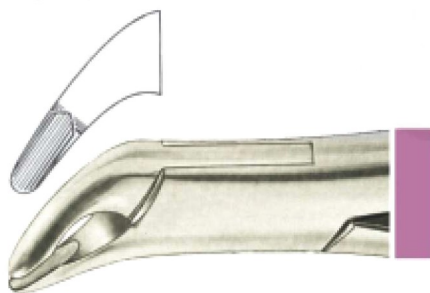

**DE-092**  
**# 151A**  
Cryer lower incisors, premolars, roots

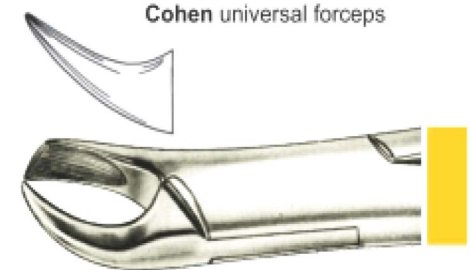

**DE-097**  
**# 89**  
Upper molars, right



**DE-093**  
**# 151 S**  
Cryer lower incisors, premolars, roots

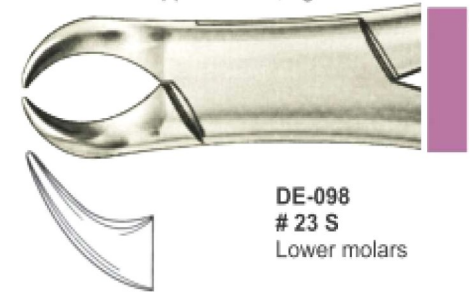

**DE-098**  
**# 23 S**  
Lower molars

# EXTRACTING FORCEPS (AMERICAN PATTERN)

- Щипцы экстракционные (американская форма)
- Daviers - forme américaine
- Fórceps de extracción - forma americana
- Щипці екстракційні (американська форма)
- Pinzoper per estrazione - forma americana
- ستخراج المنقط (النمط الأمريكي)

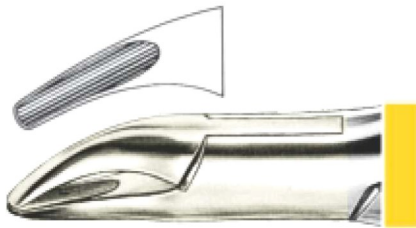
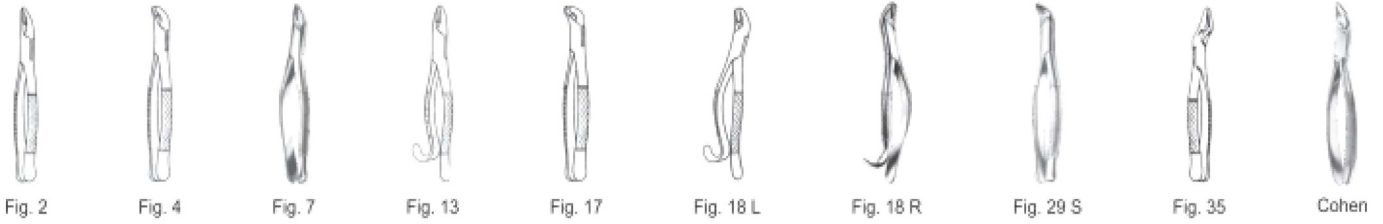

**DE-099**  
# 2  
upper and lower roots

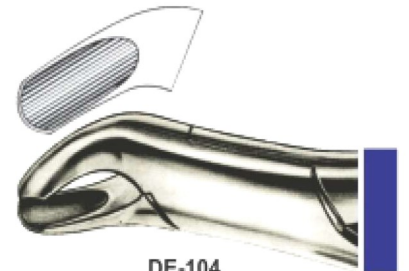

**DE-104**  
# 18 L  
Harris upper molars, left

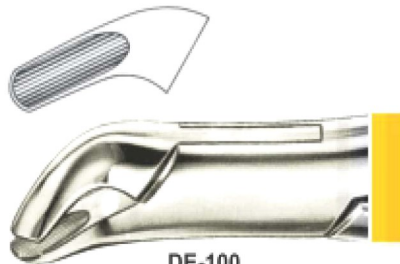

**DE-100**  
# 4  
upper and lower premolars

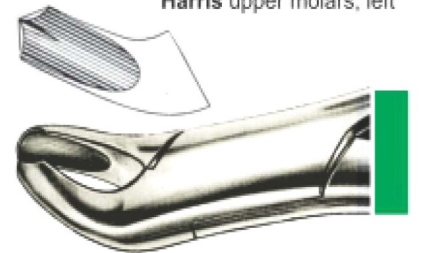

**DE-105**  
# 18R  
Harris upper molars, right



**DE-101**  
# 7  
upper roots

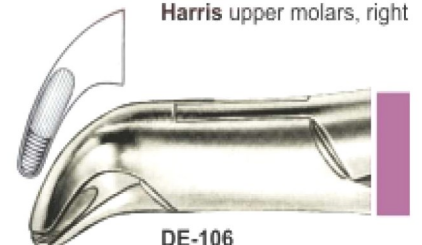
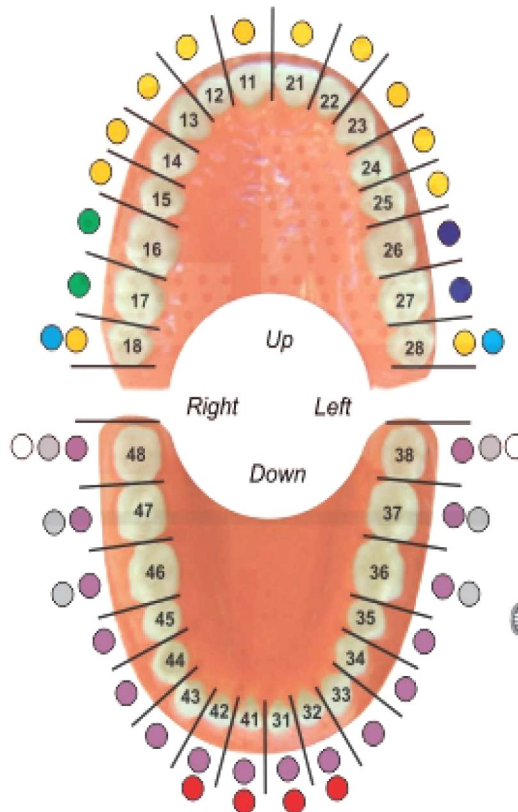

**DE-106**  
# 29S  
lower teeth, for children

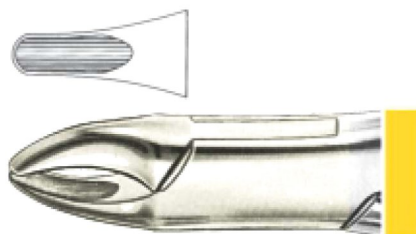

**DE-102**  
# 13  
upper incisors



**DE-107**  
# 35  
upper roots



**DE-103**  
# 17  
lower molars

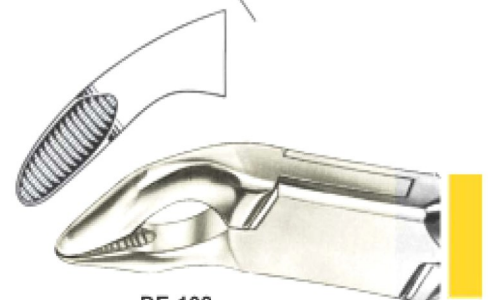

**DE-108**  
Cohen  
universal forceps

- Щипцы экстракционные (американская форма)
- Daviers - forme américaine
- Fórceps de extracción - forma americana
- Щипці екстракційні (американська форма)
- Pinzere per estrazione - forma americana
- استخراج الملقط (النمط الأمريكي)



**DE-109**  
Fig. 1  
Upper Anterior

**DE-110**  
Lower Molar  
Fig. 23 Cow Horn



**DE-111**  
Fig. 74  
Lower Anterior



**DE-112**  
Fig. 88L  
Upper Molar Left



**DE-113**  
Fig. 88R  
Upper Molar Right



**DE-114**  
Fig. 74  
Lower Anterior



**DE-115**  
Fig. 106  
Lower Incisors



**DE-116**  
Fig. 174  
Extra Narrow  
Lower Anterior  
Apical Retention  
Forceps



**DE-117**  
Fig. 859  
Lower Molars  
Roots



# DENTAL SYRINGES

- Шприцы стоматологические карпульные
- Seringues à usage dentaire
- Dentalspritzen
- Шприці стоматологічні карпульні
- Jeringas dentales
- المحاقن الأسنان



DE-118 1.8ML  
DE-119 2.2ML



DE-130  
# 1001  
Intraligamental  
Anesthesia Syringe  
in Black Colour



DE-120 1.8ML  
DE-121 2.2ML



DE-131 1.8ML  
DE-132 2.2ML  
Angled

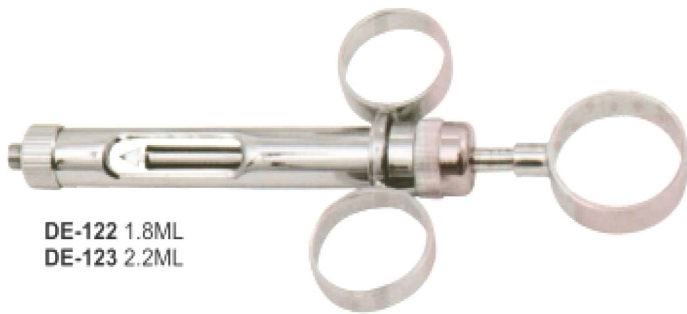

DE-122 1.8ML  
DE-123 2.2ML



DE-133  
Aluminium - Dark 1.8 ml



DE-124 1.8ML  
DE-125 2.2ML



DE-134  
Aluminium - Silver 1.8 ml



DE-126 1.8ML  
DE-127 2.2ML



DE-135  
Aluminium - Orange 1.8 ml



DE-128 1.8ML  
DE-129 2.2ML



DE-136  
Aluminium - Green 1.8 ml



DE-137  
Aluminium - Blue 1.8 ml





**DeMaanz Industries**

- Костные кусачки
- Hohlmeißelzangen
- Pincés-gouges
- Кусачки для кісток
- Pinzas-gubias
- روتچپورس العظام

# BONE ROUNGER



**DE-138**  
Blumenthal  
15cm



**DE-139**  
Blumenthal  
15cm



**DE-140**  
Blumenthal  
15cm



**DE-141**  
Friedman  
14cm



**DE-142**  
Friedman  
14.5cm



**DE-143**  
Micro-Friedman  
14cm



**DE-144**  
Micro-Friedman  
15cm



**DE-145**  
Micro-Friedman  
16cm



**DE-146**  
Kleinert-Kutz  
18.5cm



**DE-147**  
Beyer  
18.5cm



**DE-148**  
Mead 1A  
18.5cm



**DE-149**  
Luer  
18.5cm

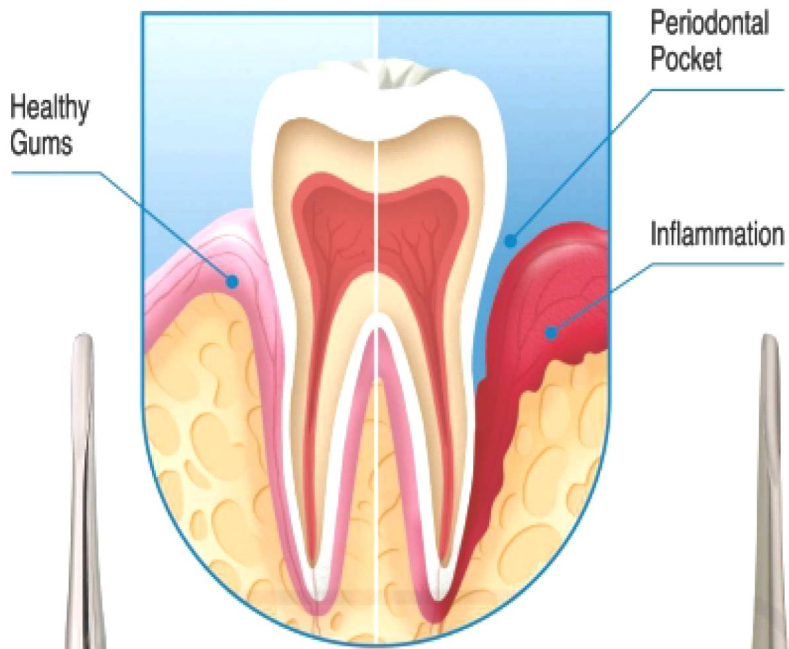

**HANDLES FOR ROOT ELEVATORS POINTS  
A, B, C, D**

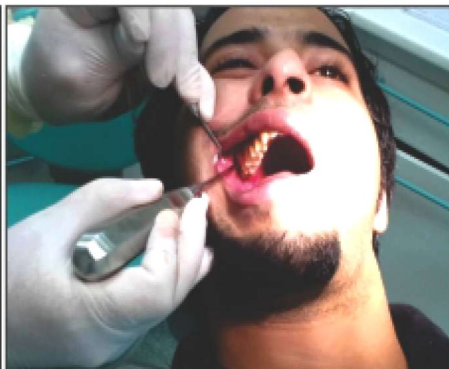
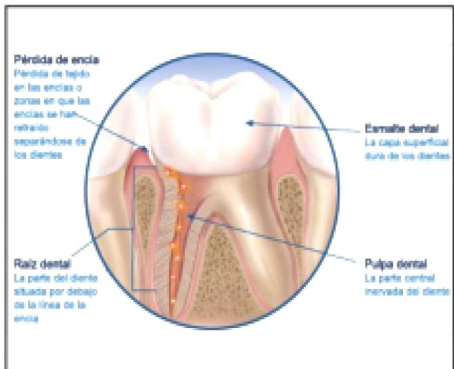

# ROOT ELEVATOR

- Элеватор корневой экстракционный
- Elévateurs à racines
- Wurzelheber
- Элеватор корневий екстракційний
- Elevadores para raíces
- المصاعد الجذر

## Apexo Root Elevators



## Luxator Root Elevators



## Bein Root Elevators

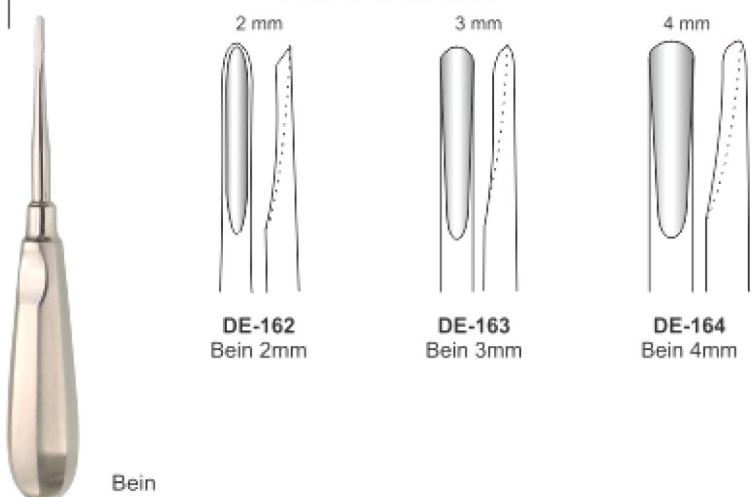

## Seldin Root Elevators

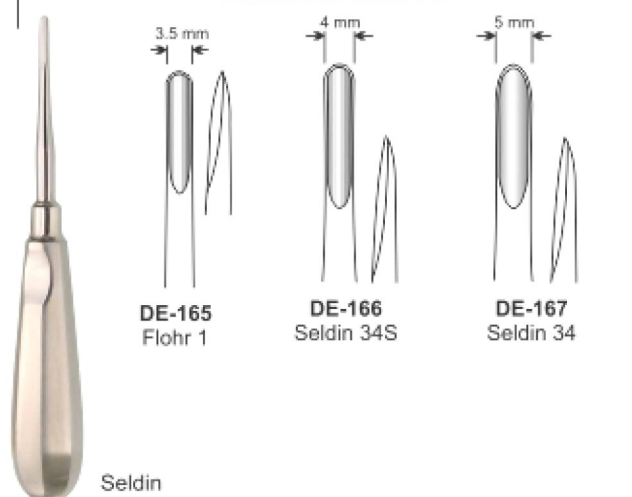

# ROOT ELEVATOR

- Элеватор корневой экстракционный
  - Elévateurs à racines
  - Wurzelheber
- Слеватор корневий экстракційний
  - Elevadores para raíces
  - المصاعد الجذر

## Apexo Root Elevators



Apexo



**DE-168**  
Apexo  
2.5x9mm  
Straight



**DE-169**  
Apexo  
2.7x9mm  
Straight



**DE-170**  
Apexo  
3.0x9mm  
Straight



**DE-171**  
Apexo  
2.5x9mm  
Curved



**DE-172**  
Apexo  
3.0x9mm  
Curved



**DE-173**  
Seldin  
3.0x14mm  
Straight

## Luxator Root Elevators



Luxator



**DE-174**  
Luxator  
3mm  
straight



**DE-175**  
Luxator  
3mm  
curved



**DE-176**  
Luxator  
4mm  
straight



**DE-177**  
Luxator  
4mm  
curved



**DE-178**  
Luxator  
5mm  
straight



**DE-179**  
Luxator  
5mm  
curved

## Bein Root Elevators



Bein



**DE-180**  
Bein 2mm



**DE-181**  
Bein 3mm

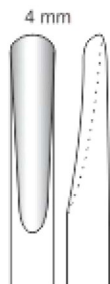

**DE-182**  
Bein 4mm

## Seldin Root Elevators



Seldin



**DE-183**  
Flohr 1



**DE-184**  
Seldin 34S

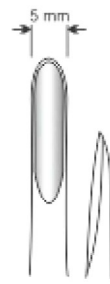

**DE-185**  
Seldin 34

# ROOT ELEVATOR

- Элеватор корневой экстракционный
- Elevateurs à racines
- Wurzelheber
- Elevator corneviy ekstraktsionnyy
- Elevadores para raices
- المصاعد الجذر

## Apical Root Elevators

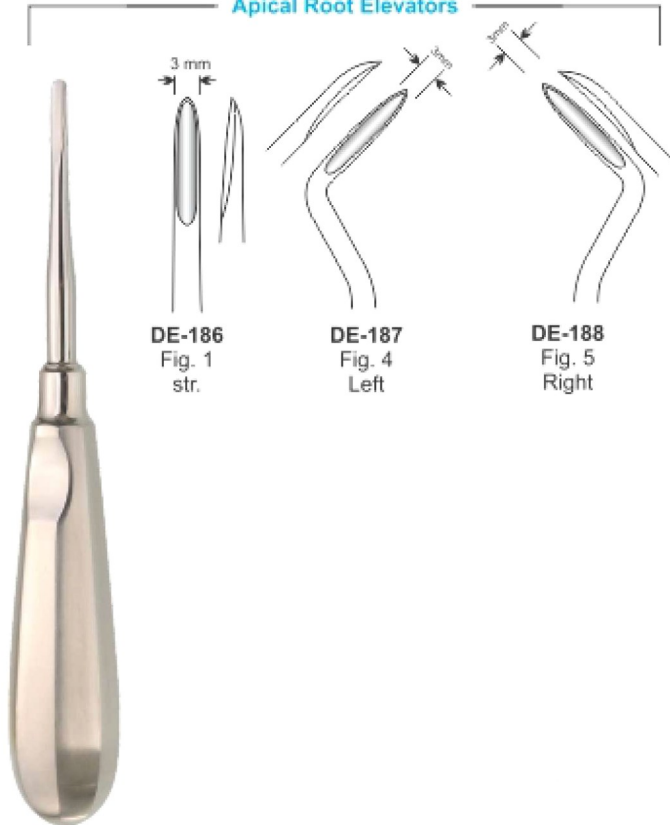

## Apical Root Elevators

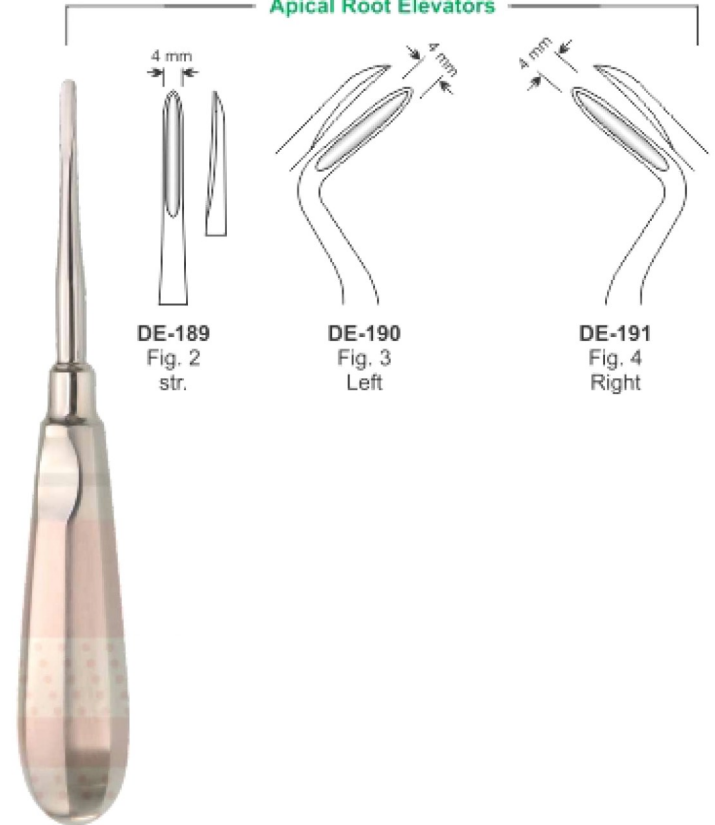

## Coupland Root Elevators

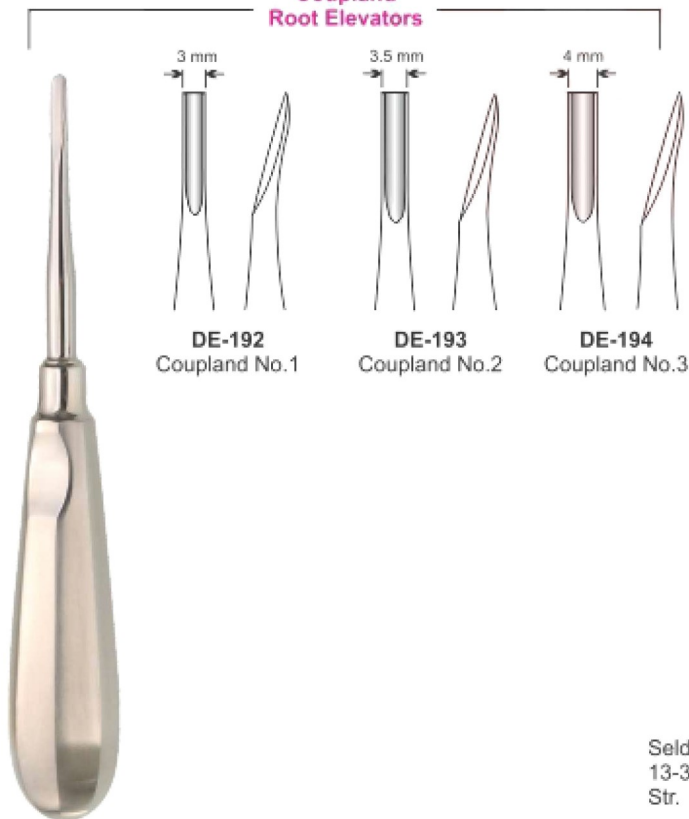

## Seldin Root Elevators

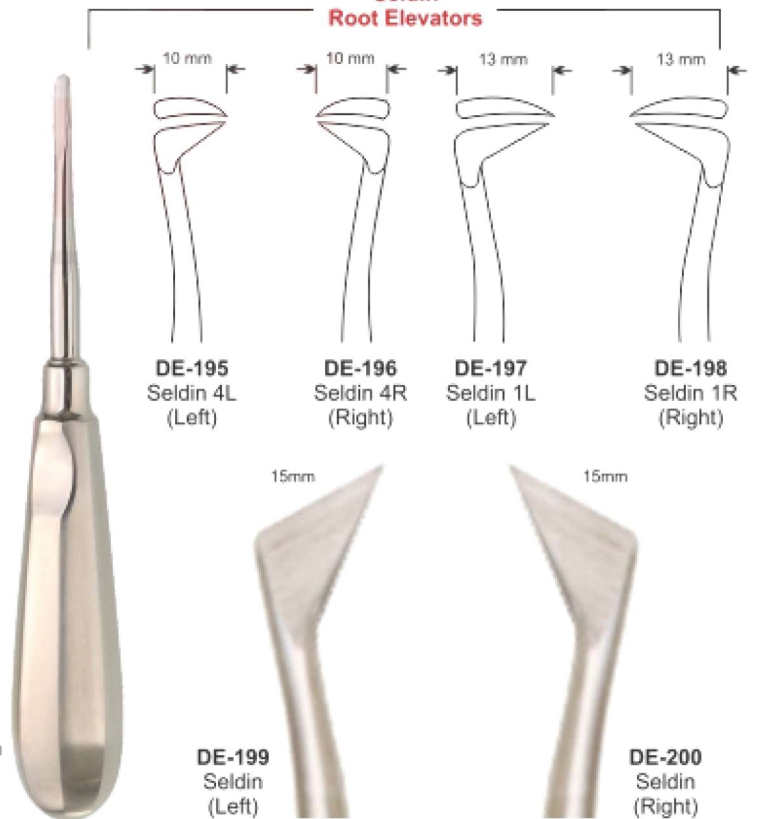

# ROOT ELEVATOR

- Элеватор корневой экстракционный
- Elévateurs à racines
- Wurzelheber

- Elevator corneviu extracționii
- Elevadores para raices
- المصاعد الجذر

## Apical Root Elevators

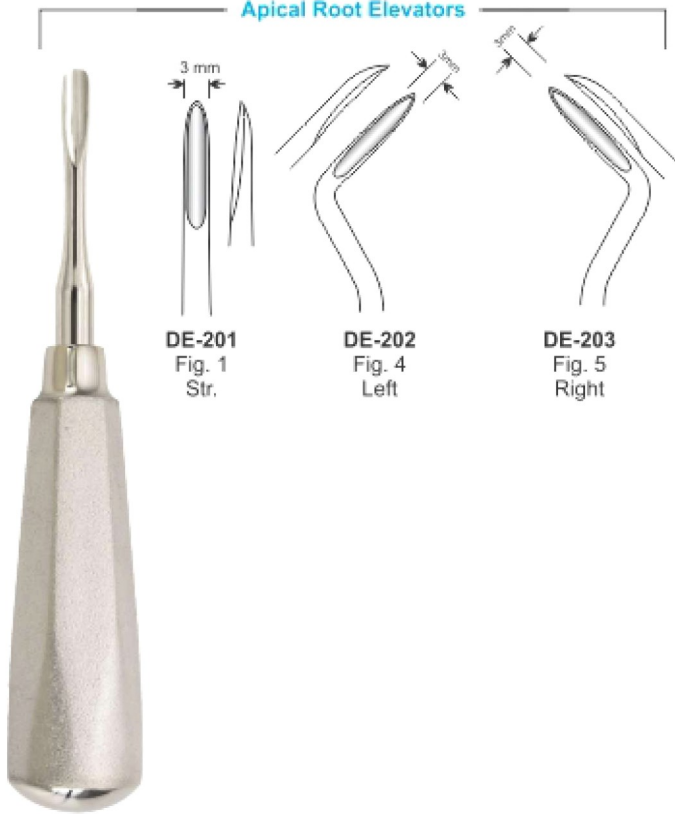

## Apical Root Elevators

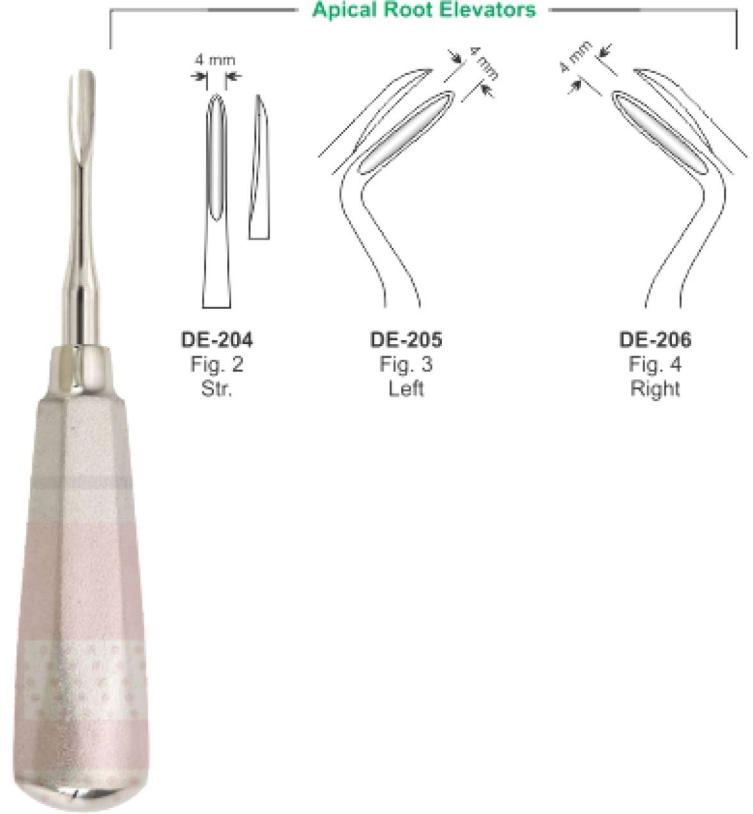

## Coupland Root Elevators

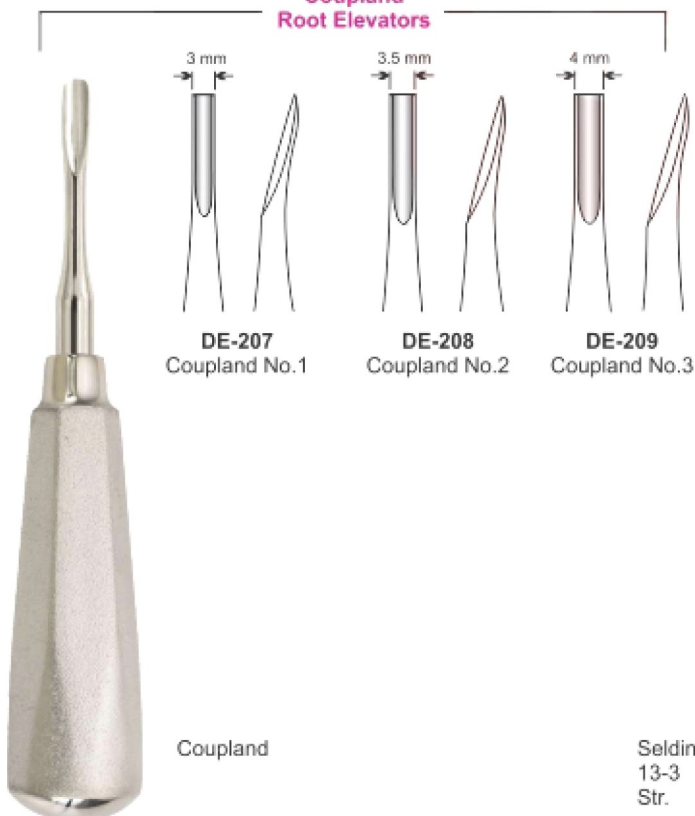

## Seldin Root Elevators

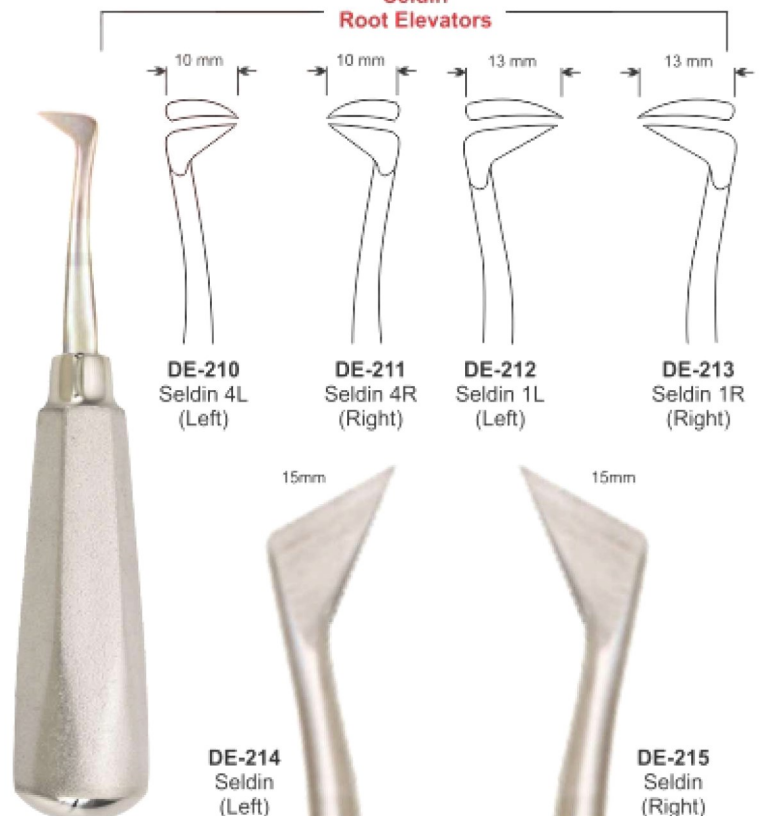

# ROOT ELEVATOR

- Элеватор корневой экстракционный
- Elévateurs à racines
- Wurzelheber
- Слеватор корневий екстракційний
- Elevadores para raices
- المصاعد الجذر

## Apical Root Elevators

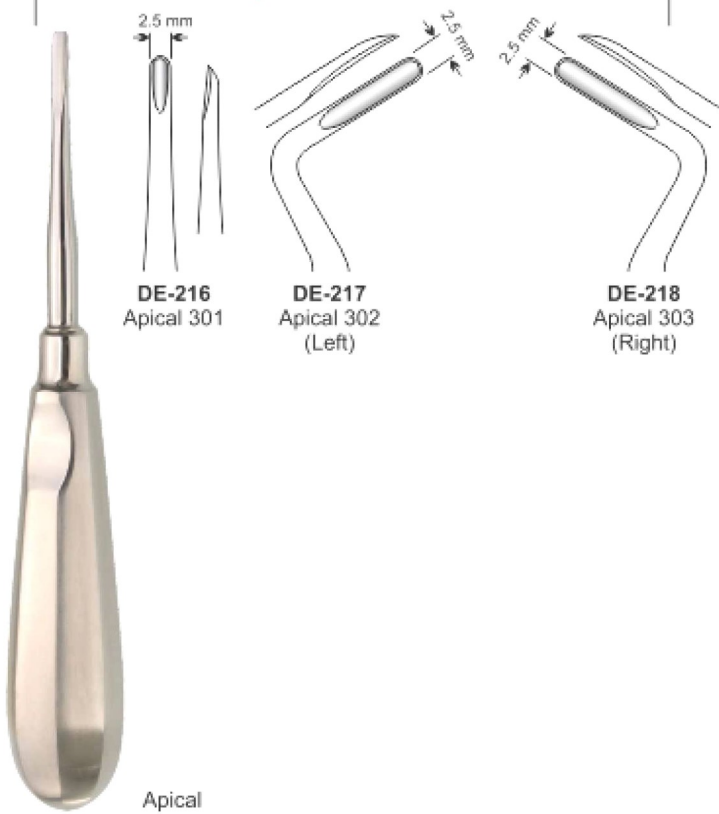

## Apical Root Elevators

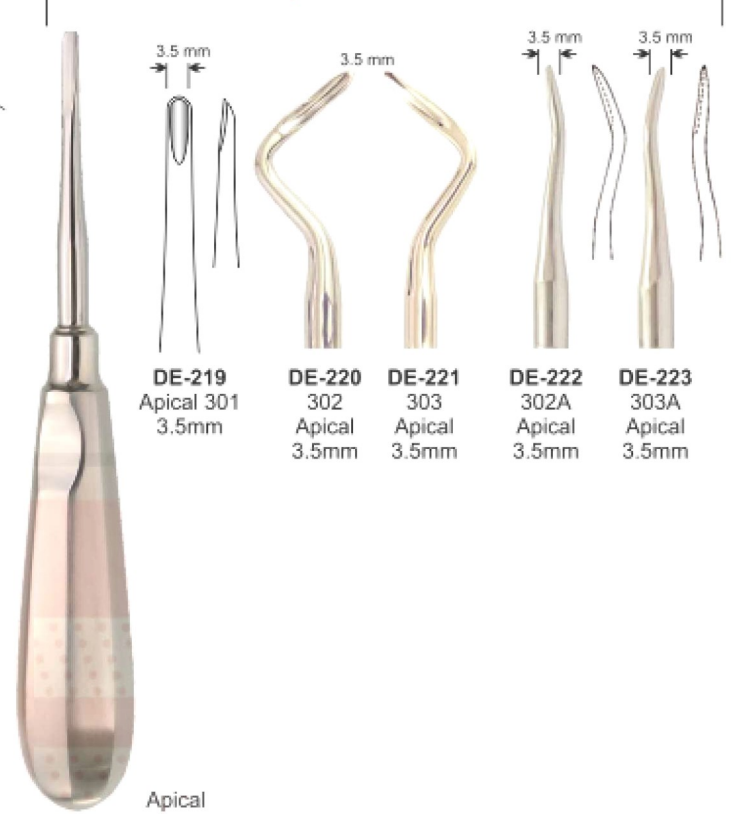

## Apical Root Elevators



## Laxutor Root Elevators

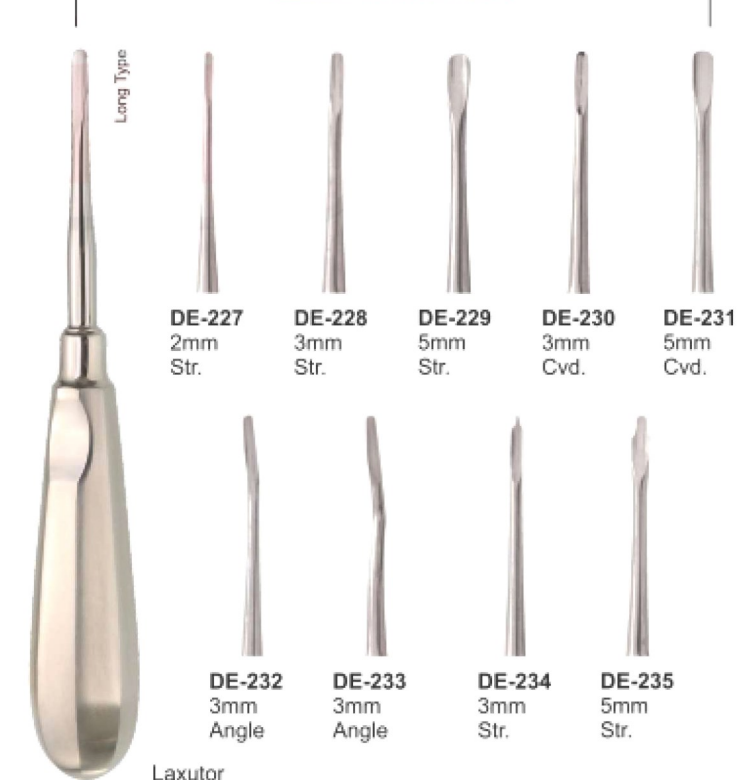

# ROOT ELEVATOR

- Элеватор корневой экстракционный
- Elevator cornevien ekstraktsionnyy
- Elévateurs à racines
- Elevadores para raices
- Wurzelheber
- المصاعد الجذر

## Lindo Levian Root Elevators

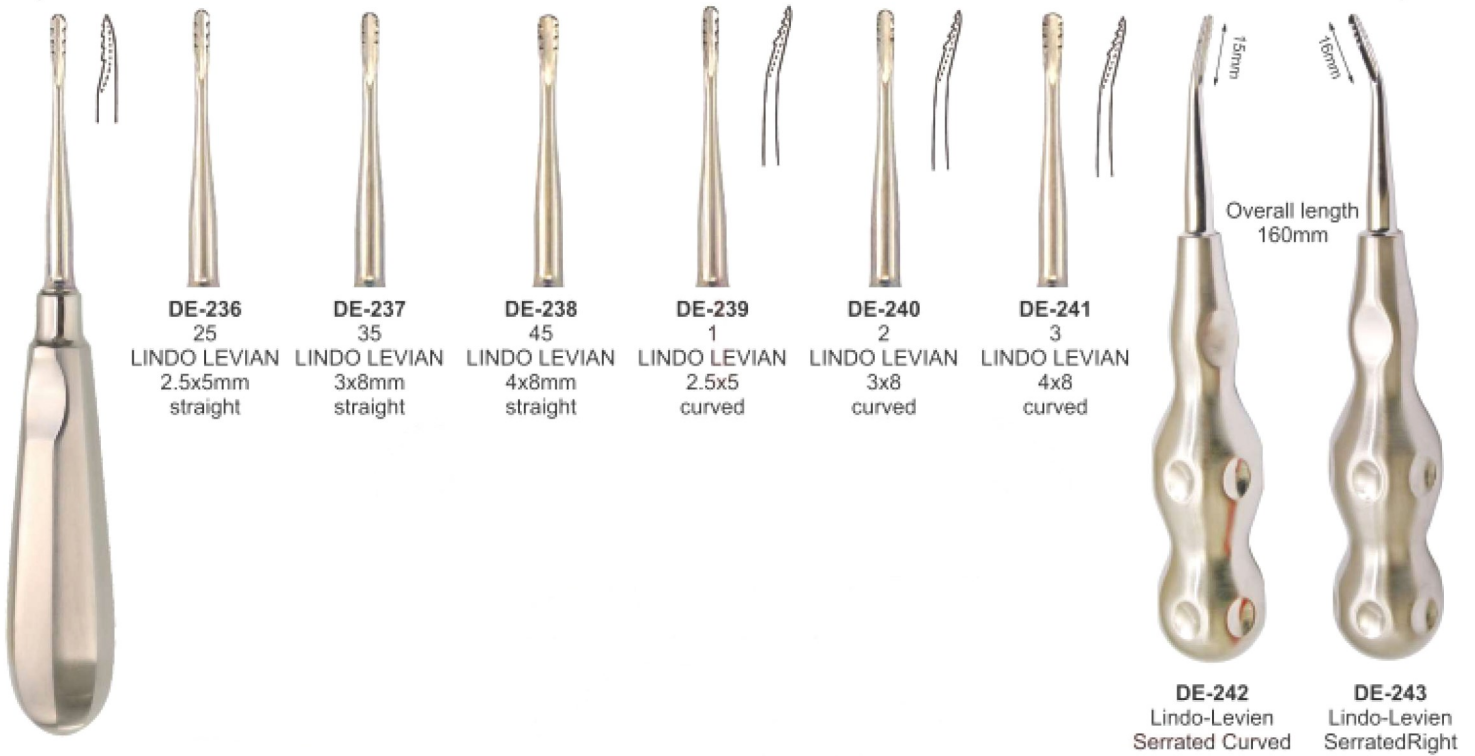

## Flohr Root Elevators



## Heidbrink Root Elevators

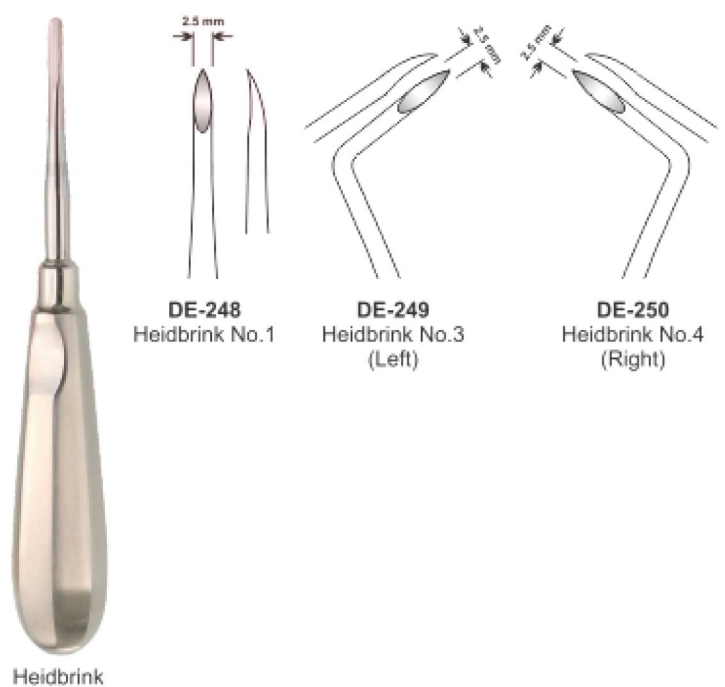



# ROOT ELEVATOR

- Элеватор корневой экстракционный
- Elévateurs à racines
- Wurzelheber

- Слеватор корневий екстракційний
- Elevadores para raíces
- المصاعد الجذر

## Friedmann Roots Elevator



**DE-251**  
Friedmann 4F  
Str.

**DE-252**  
Friedmann 5F  
Left

**DE-253**  
Friedmann 6F  
Right

## Heidbrink Roots Elevator



**DE-254**  
Heidbrink  
Straight

**DE-255**  
Heidbrink  
Left

**DE-256**  
Heidbrink  
Right

## Wisdom Roots Elevator



**DE-257**  
Wisdom  
for 18 and 38

**DE-258**  
Wisdom  
for 28 and 48

## Bayonet Roots Elevator Set

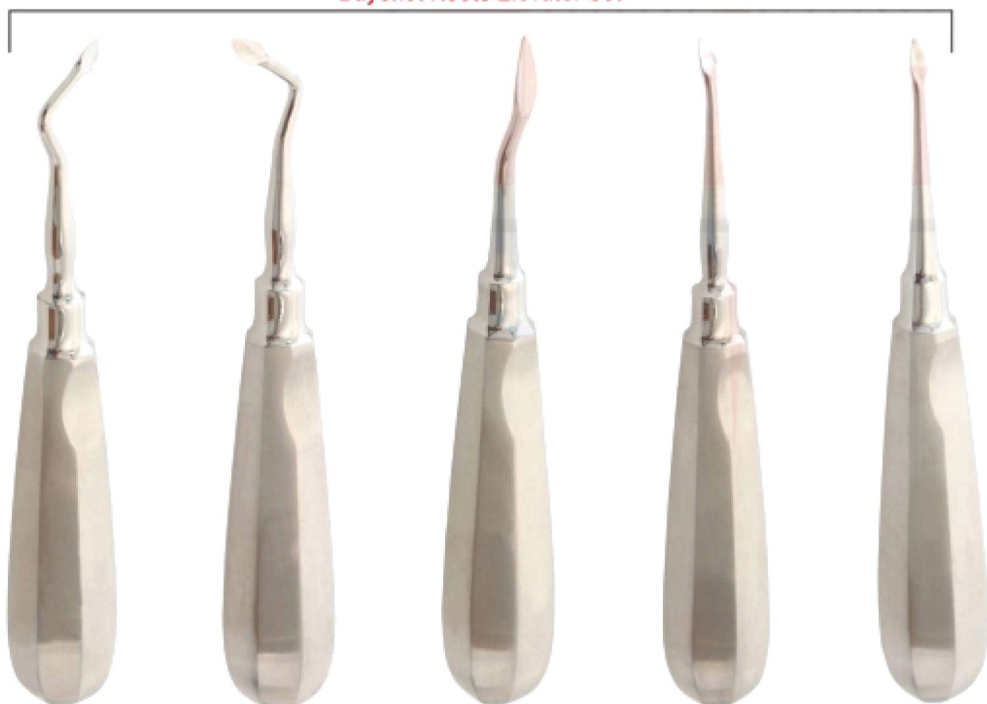

**DE-259**  
Left

**DE-260**  
Right

**DE-261**  
bayonet

**DE-262**  
Curved

**DE-263**  
Straight

## Luxator Roots Elevator



**DE-264**  
Luxator  
Straight

**DE-265**  
Luxator  
Curved

# ROOT ELEVATOR

- Элеватор корневой экстракционный
- Слеватор корневий екстракційний
- Elévateurs à racines
- Elevadores para raíces
- Wurzelheber
- المصاعد الجذر

## Roots Elevator

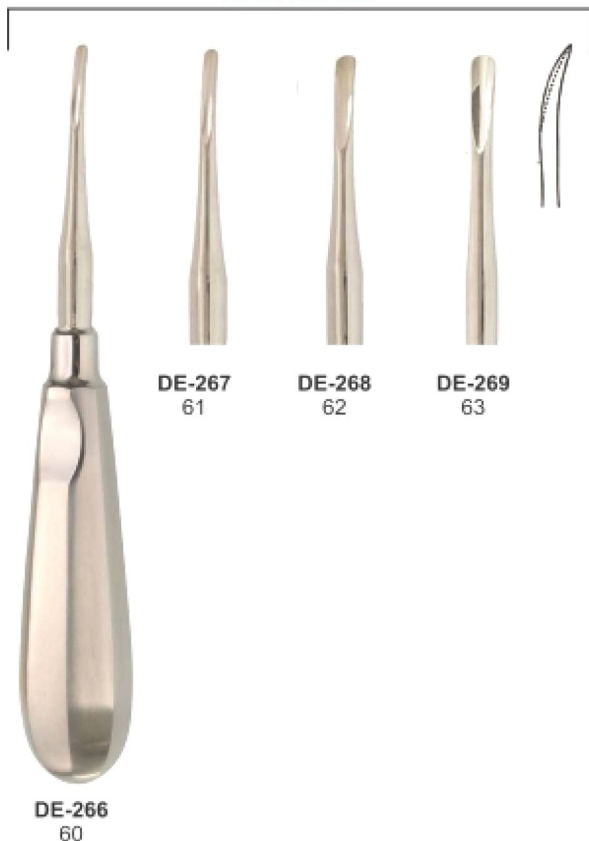

## Luxier Roots Elevator



## Luxier Roots Elevator



## Claw-Lift Roots Elevator



# ROOT ELEVATOR

- Elevator корневой экстракционный
- Elévateurs à racines
- Wurzelheber
- Elevator корневий экстракційний
- Elevadores para raíces
- المعصاع الجذر

## Hylin Roots Elevator



## Cryer Roots Elevator



## Kopp Roots Elevator

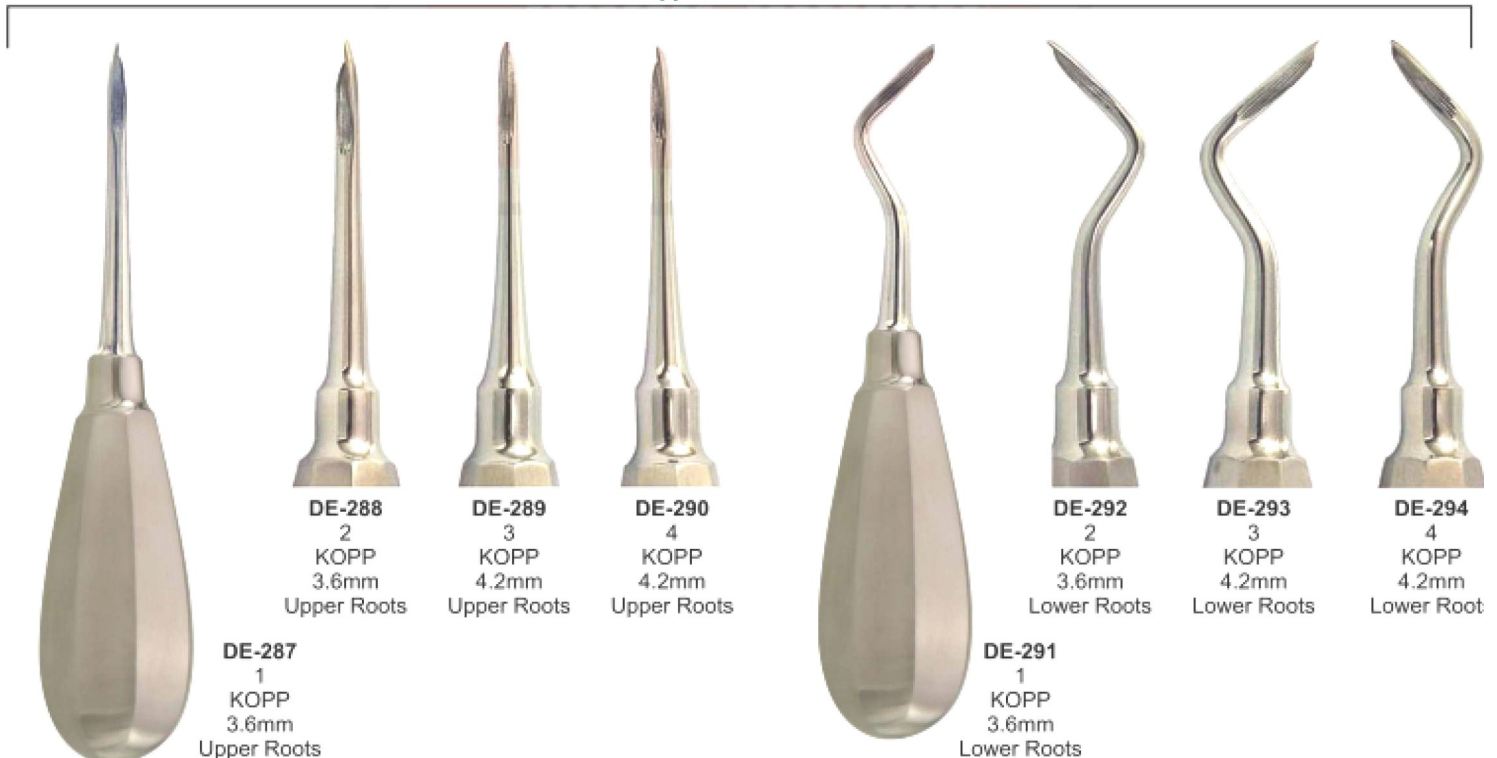

# ROOT ELEVATOR

- Элеватор корневой экстракционный
- Elévateurs à racines
- Wurzelheber

- Слеватор корневий екстракційний
- Elevadores para raices
- المعصاعد الجذر

## Kopp Roots Elevator



**DE-295**  
Kopp  
Right

**DE-296**  
Kopp  
Left

## Heber Roots Elevator



**DE-297**  
Heber  
Bayonet

**DE-298**  
Heber  
Bayonet

## Bein Roots Elevator



**DE-299**  
Bein,  
3mm

**DE-300**  
Bein,  
4mm

## Bein Roots Elevator



**DE-302**  
2mm  
straight  
serrated

**DE-303**  
3mm  
straight

**DE-304**  
4mm  
Curved

**DE-306**  
2mm  
straight  
serrated

**DE-307**  
3mm  
straight

**DE-308**  
4mm  
Curved

**DE-310**  
2mm  
straight  
serrated

**DE-311**  
3mm  
straight

**DE-312**  
4mm  
Curved

**DE-301**  
Bein  
2mm, curved  
serrated

**DE-305**  
Bein  
2mm, curved  
serrated

**DE-309**  
Bein  
2mm, curved  
serrated

# ROOT ELEVATOR

- Элеватор корневой экстракционный
  - Elévateurs à racines
  - Wurzelheber
- Єлеватор кореневий екстракційний
  - Elevadores para raíces
  - المضاعد الجذر

## Seldin Roots Elevator



## W. Barry Roots Elevator



## Winter Roots Elevator



## Pott Roots Elevator



# ROOT ELEVATOR

- Элеватор корневой экстракционный
- Elévateurs à racines
- Wurzelheber

- Слеватор корневий екстракційний
- Elevadores para raíces
- المصاعد الجذر

## Heidbrink Roots Elevator



**DE-338**  
Heidbrink  
Straight

**DE-339**  
Heidbrink  
Left

**DE-340**  
Heidbrink  
Right

**DE-341**  
Heidbrink  
Straight

**DE-342**  
Heidbrink  
Left

**DE-343**  
Heidbrink  
Right

## Syndesmotomes Roots Elevator



**DE-344**  
Straight

**DE-345**  
Left

**DE-346**  
Right

## Periotome Roots Elevator



**DE-347**  
Periotome  
2.1mm  
Straight

**DE-348**  
Periotome  
2.6mm  
Straight

**DE-349**  
Periotome  
2.1mm  
Angular

**DE-350**  
Periotome  
2mm  
Curved

**DE-351**  
Periotome  
2.0mm

**DE-352**  
Periotome  
2.5mm

**DE-353**  
Periotome  
3.0mm

**DE-354**  
Periotome  
4.0mm

Syndesmotomes

# ROOT ELEVATOR

- Элеватор корневой экстракционный
- Elévateurs à racines
- Wurzelheber
- Слеватор корневий екстракційний
- Elevadores para raices
- المصاعد الجذر



**DE-355**  
1S  
(Straight 1mm)



**DE-356**  
2S  
(Straight 2mm)



**DE-357**  
3S  
(Straight 3mm)



**DE-358**  
5S  
(Straight 5mm)



**DE-359**  
3C  
(Curved 3mm)



**DE-360**  
5C  
(Curved 5mm)



**DE-361**  
3CA  
(Curved Angle 3mm)



**DE-362**  
3IC  
(Inverted Curved 3mm)



**DE-363**  
DE 3  
(Dual Edge 3mm / 1.5mm)



**DE-364**  
DE 5  
(Dual Edge 5mm / 3mm)

# ROOT ELEVATOR

- Элеватор корневой экстракционный
  - Elévateurs à racines
  - Wurzelheber
- PDL ELEVATORS**

- Elevator coronevii ekstraktsionnyy
- Elevadores para raices
- المصاعد الجذر

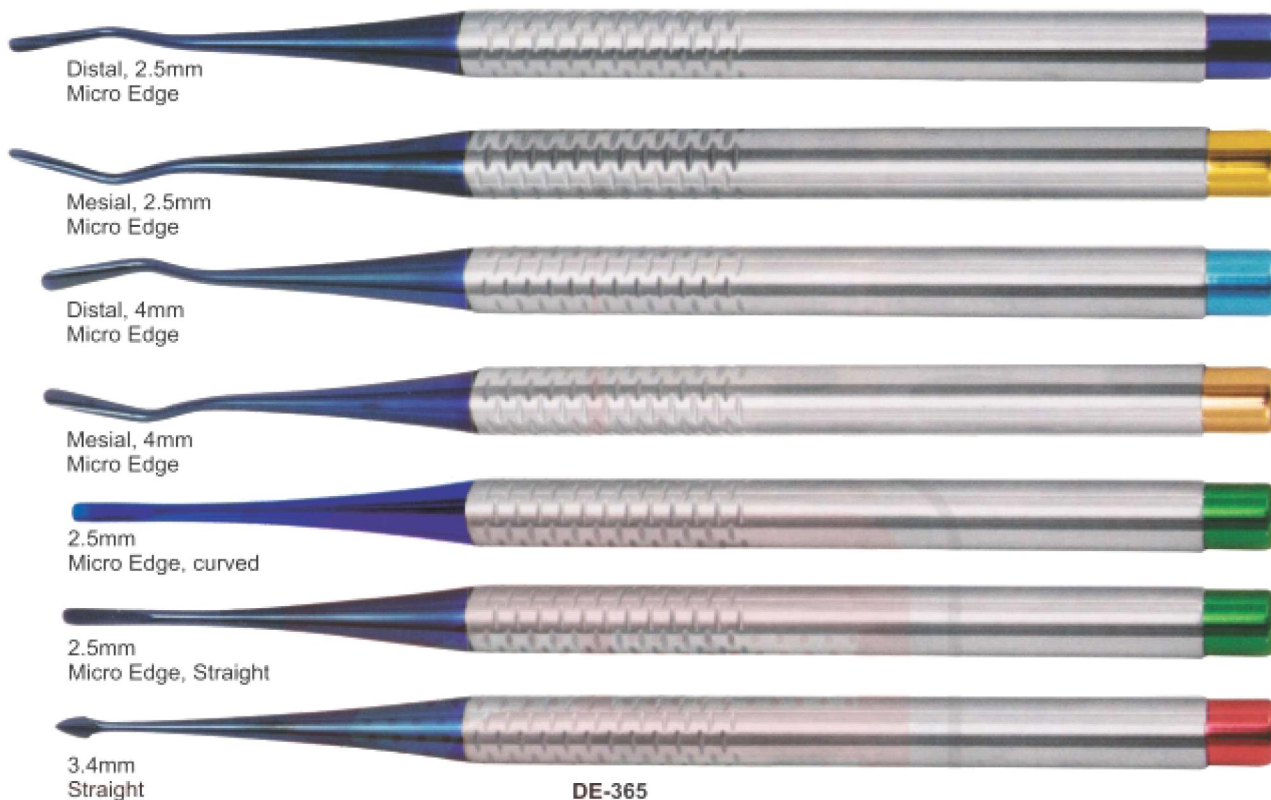

**DE-365**  
PDL Elevators  
Set of 7 Pcs

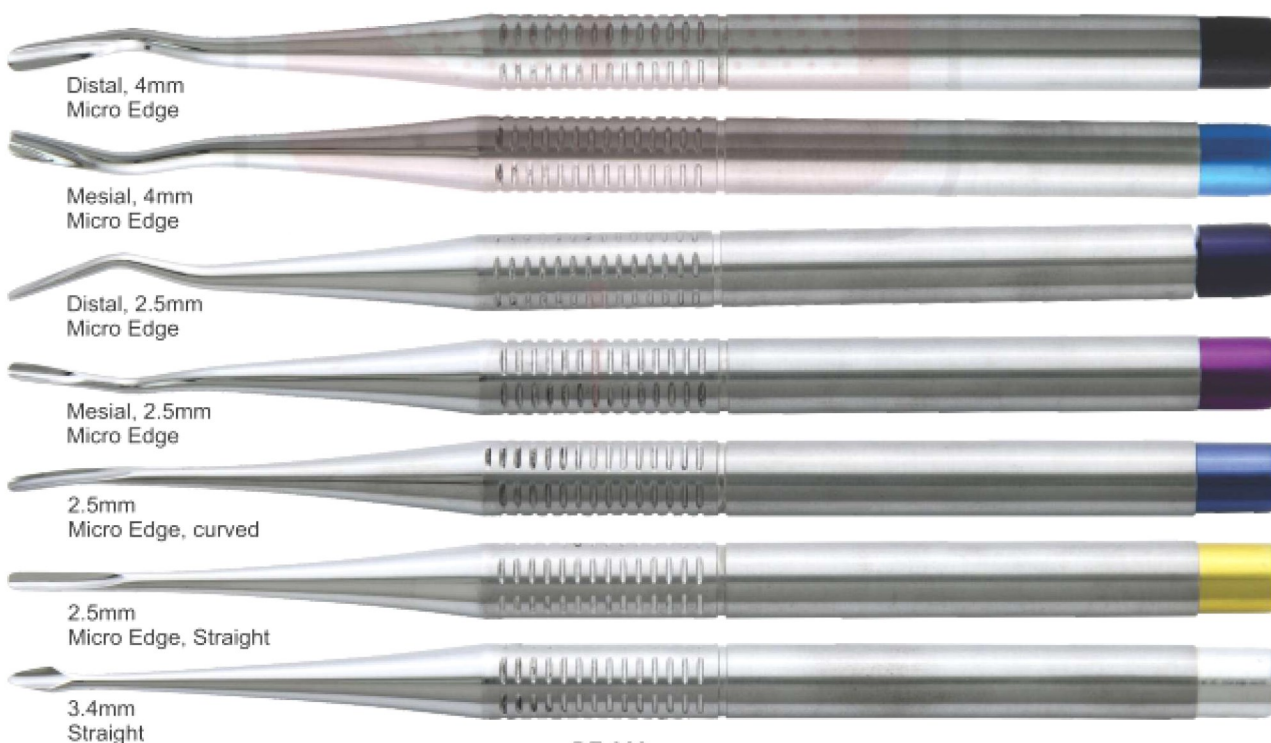

**DE-366**  
PDL Elevators  
Set of 7 Pcs



# ROOT ELEVATOR

- Элеватор корневой экстракционный
- Elévateurs à racines
- Wurzelheber
- Слеватор корневий екстракційний
- Elevadores para raices
- المصاعد الجذر

## PDL ELEVATORS

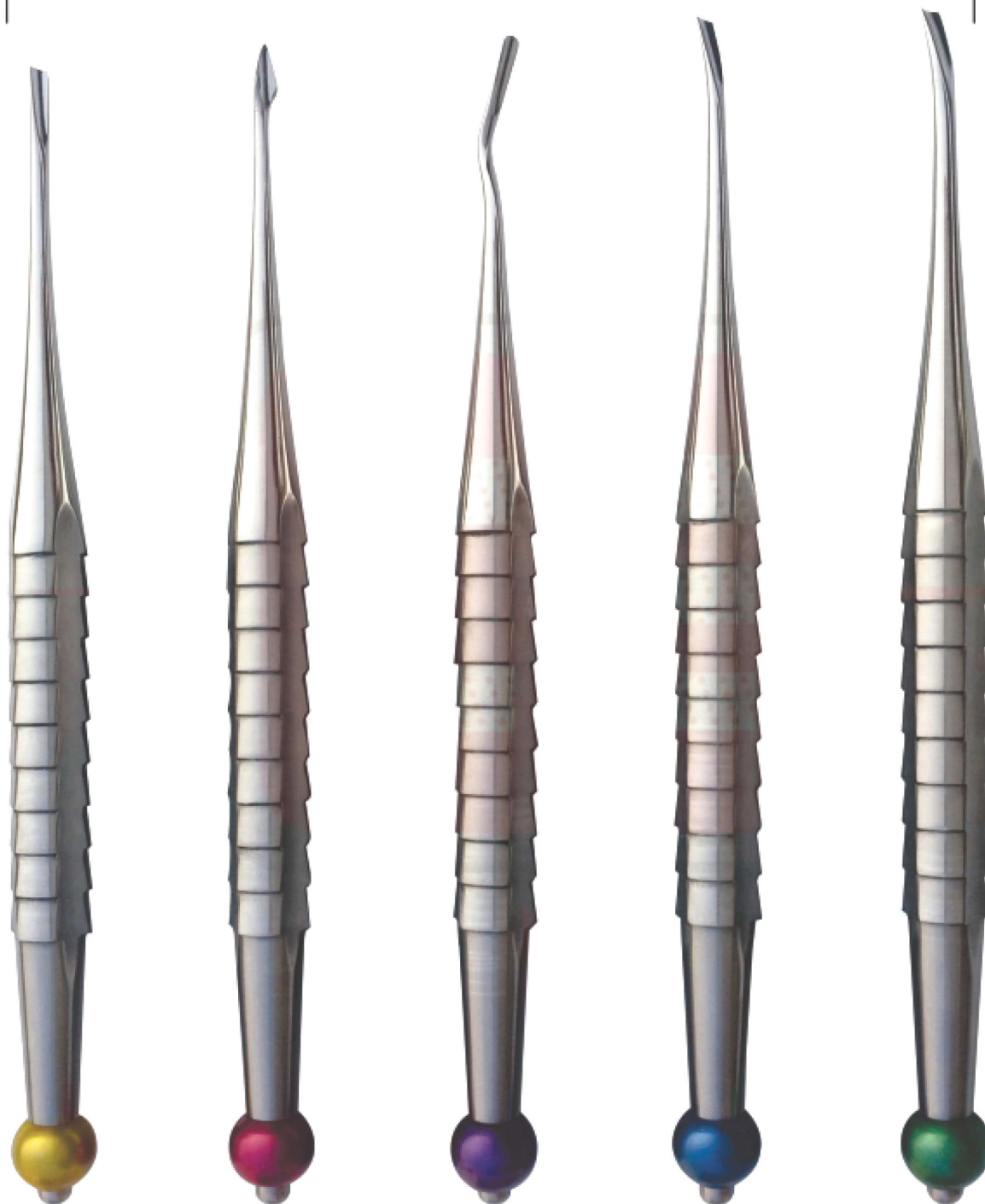

DE-367  
PDL Elevators  
Set of 5 Pcs

# DIAGNOSTIC PROBES SCALERS, FILLING & LABORATORY INSTRUMENTS

## *Our Scalars*

Compare our scalars and curettes with the best in the industry and you will immediately recognize we are equal in every way but one... price.

Note the deep precision knurling for better tactile feel. The same high-grade stainless steel tips, the same light weight (under 18 grams) for less hand fatigue, the same professional craftsmanship, and surpassing the highest industry standards. of course, any manufacturer can make these claims, but we guarantee and certify ours.

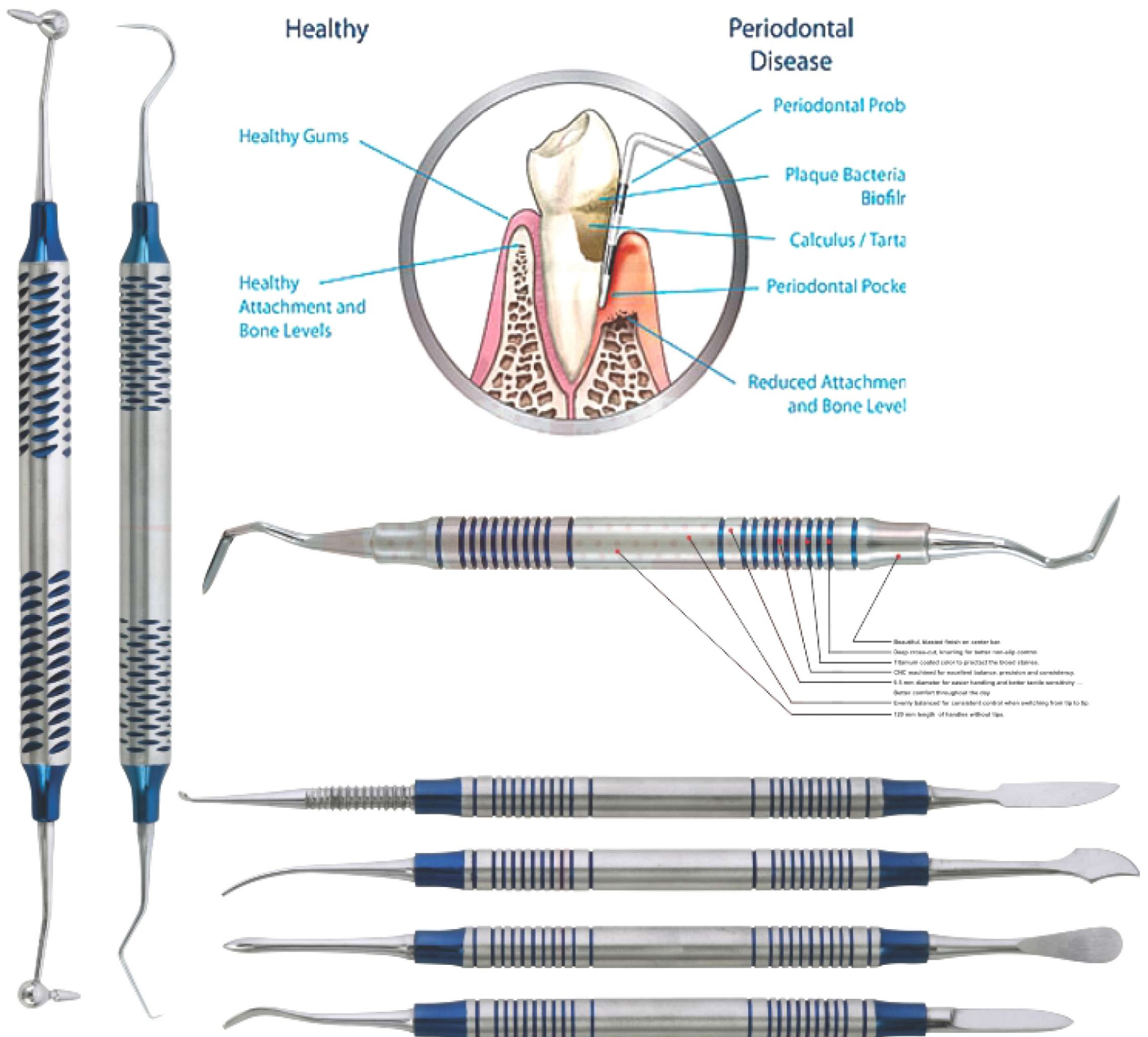

- High-polish mirror finish tips.
- Manufactured within the guidelines of the FDA quality assurance system for good manufacturing practices.
- Highest grade German stainless steel, razor sharp, durable tips. Rockwell hardened to 60 RHc.
- 27 of the most popular designs from graceys to McCalls to cumbias, and many european patterns.
- All instruments are guaranteed against defects in material and workmanship.

- All instruments bear the ce mark, emblematic of the european community's highest standards.
- Customer satisfaction guarantee, too!
- Less than 20 grams ... Lightweight for less hand fatigue.
- Manufactured to the most exacting standards so the 50th instrument you buy is exactly like your first.
- You decide ... Why pay more for the same high-quality instruments?

# DIAGNOSTIC PROBES SCALERS, FILLING & LABORATORY INSTRUMENTS

- Ручки для зеркал
- Manches pour miroirs à bouche
- Mundspiegelgriffe
- Ручки для дзеркал
- Mangos para espejos de boca
- مقابض لمرآة الفم



Magnifying

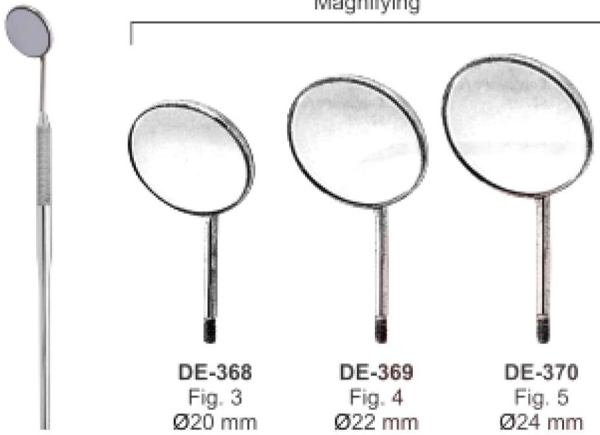

Plain

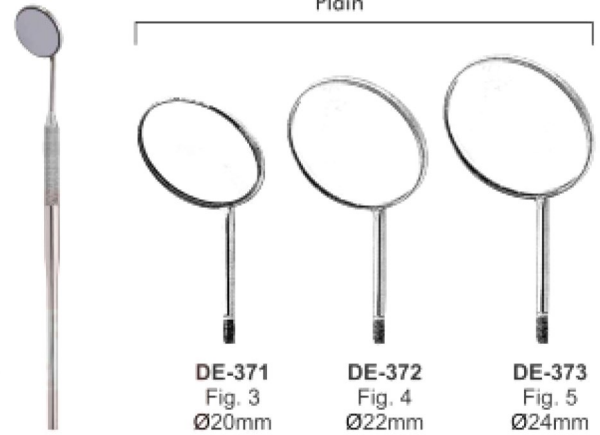

Rhodium

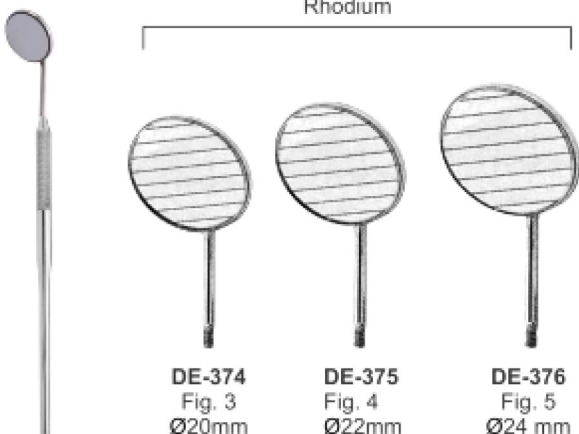

# TWEEZERS

- Пинцеты
- Précelles - Brucelles
- Zahnpinzetten

- Пінцети
- Pinzas para algodón
- ملاقط



**DE-381**  
Surgical  
11.5cm



**DE-382**  
London College  
15cm



**DE-383**  
Semken Taylor  
Str.



**DE-384**  
Semken Taylor  
Cvd.



**DE-385**  
Meriam  
16cm



**DE-386**  
Dressing  
14cm



**DE-387**  
Semken Taylor  
1x2 Straight



**DE-388**  
Semken Taylor  
1x2 Curved



**DE-389**  
Gilles  
15cm 1x2



**DE-390**  
14cm 1x2



**DE-391**  
Perry  
13cm



**DE-392**  
Atraumatic  
15cm Cvd



**DE-393**  
Atraumatic  
15cm Str.



**DE-394**  
College with Lock  
15cm Cvd.



**DE-395**  
Gerald  
17.5cm



**DE-396**  
with lock  
15cm



**DE-397**  
Atraumatic  
17.5cm

# TWEEZERS

- Пинцеты
- Précelles - Brucelles
- Zahnpinzetten

- Пинцети
- Pinzas para algodón
- ملاقط



**DE-398**  
Adson-TC  
12cm



**DE-399**  
Adson-TC  
12cm 1x2



**DE-400**  
Adson-TC  
15cm 1x2



**DE-401**  
Adson  
12cm



**DE-402**  
Adson  
12cm 1x2



**DE-403**  
Adson  
15cm 1x2



**DE-404**  
Adson Brown  
12cm



**DE-405**  
Crane Kaplan  
15cm



**DE-406**  
Crane Kaplan  
15cm



**DE-407**  
Crane Kaplan  
15cm



**DE-408**  
Hemingway  
15cm



**DE-409**  
Miller  
15cm Str.



**DE-410**  
Miller  
15cm Cvd.



**DE-411**  
Dressing  
Tweezer  
14.5cm



**DE-412**  
College  
Curved  
Tip 15cm



**DE-413**  
Maryam  
Tweezers  
15cm



**DE-414**  
College  
Tweezer  
15cm



**DE-415**  
Perry  
Tweezer  
12.5cm



**DE-416**  
Self-locking  
Tweezer  
15cm

# EXPLORERS

- Зонды
- Sondes
- Zahnsonden
- Зонди
- Sondas
- المستكشفين

Single Ended Probe Solid Handle 4.5mm Length 150mm

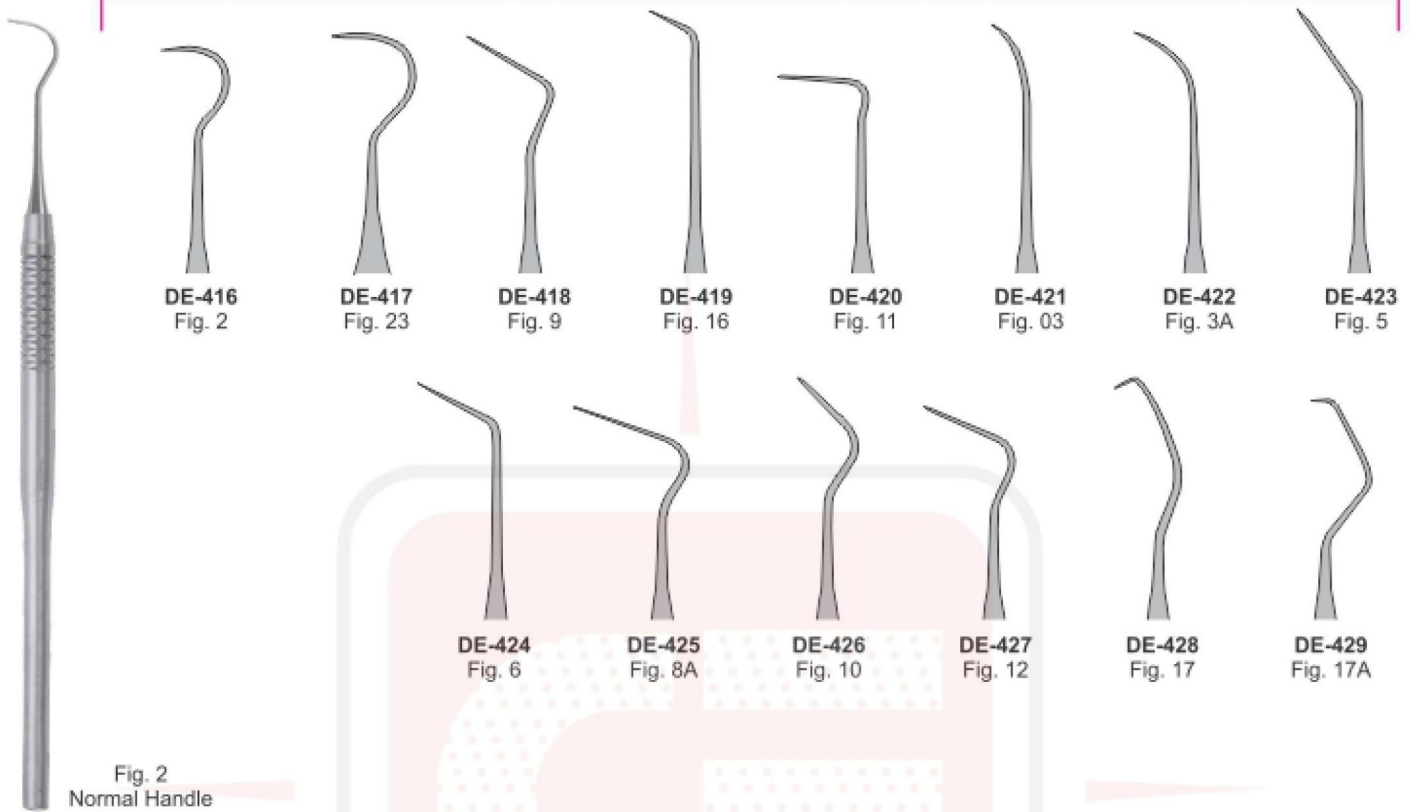

Single Ended Probe Hollow Handle 8.5mm Length 150mm

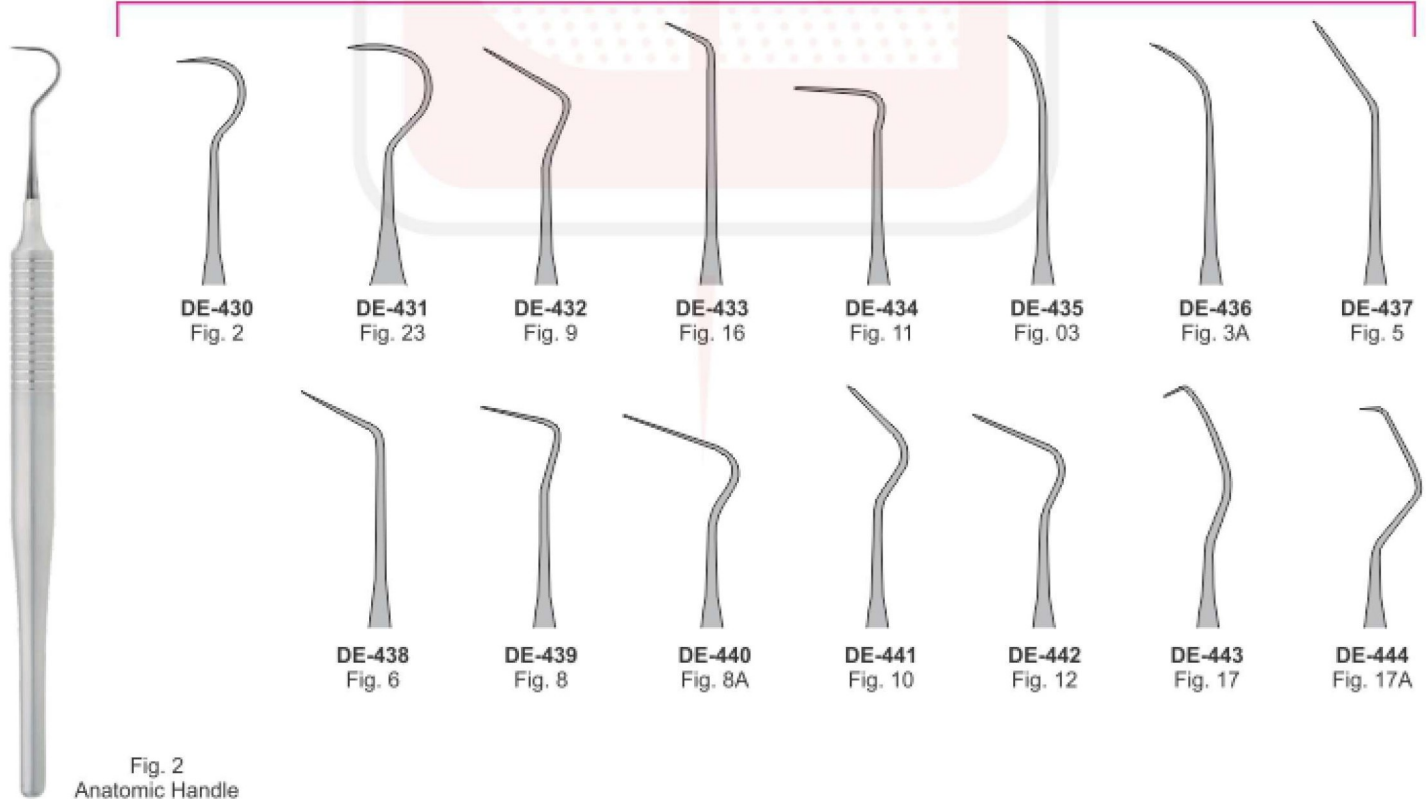

# EXPLORERS

- Зонды
- Sondes
- Zahnsonden
- Зонди
- Sondas
- المستكشفين

Probes Single End Solid Handle 6mm, length 150mm

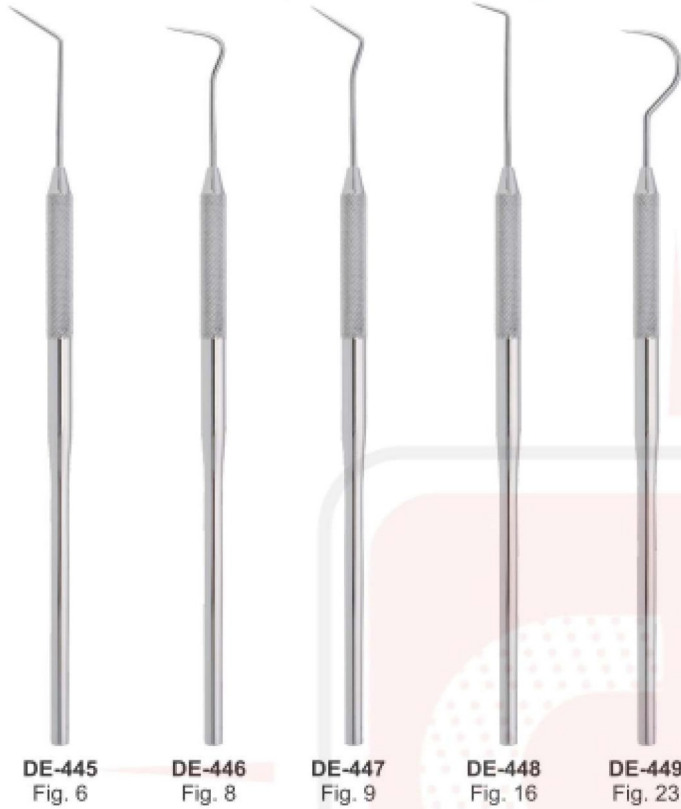

Probes Single Ended 6mm, length 150mm

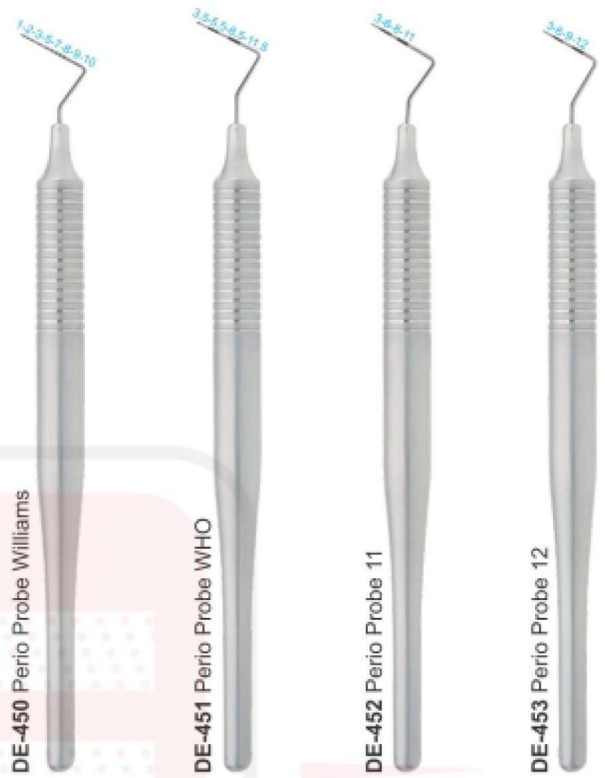

Examination kit Set of 3 Pieces



Examination Set of 4 Pieces



Examination Set of 4 Pieces



# EXPLORERS

**EXPLORERS INSTRUMENTS  
SOLID HANDLE 6MM, LENGTH 170MM**

- Зонды
- Зонди
- Sondes
- Sondas
- Zahnsonden
- المستكشفين

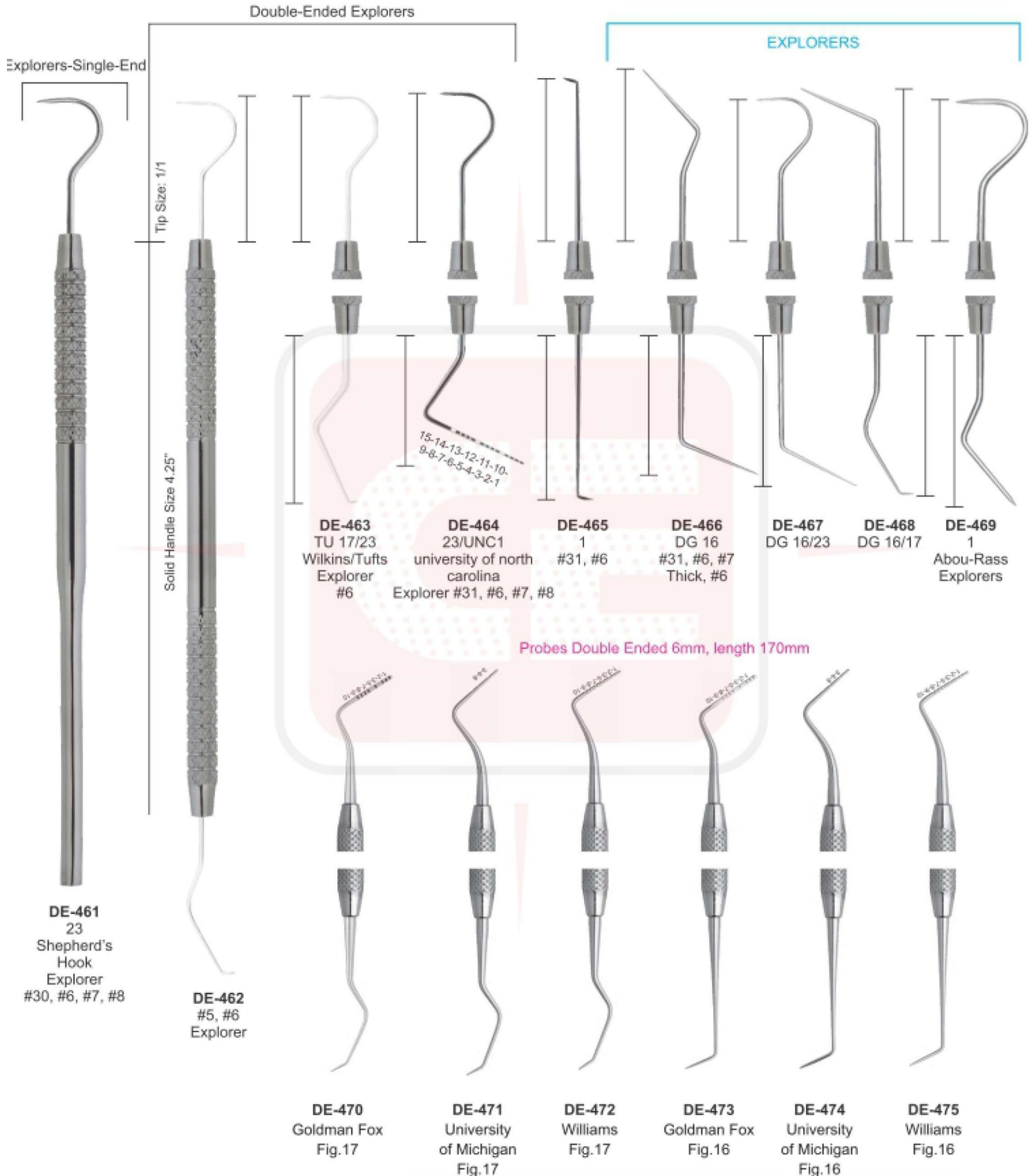



# EXPLORERS

- Зонды
  - Sondes
  - Zahnsonden
- Зонди
  - Sondas
  - المستكشفين

Pointed Probes Single Ended Handle 6mm, length 150mm

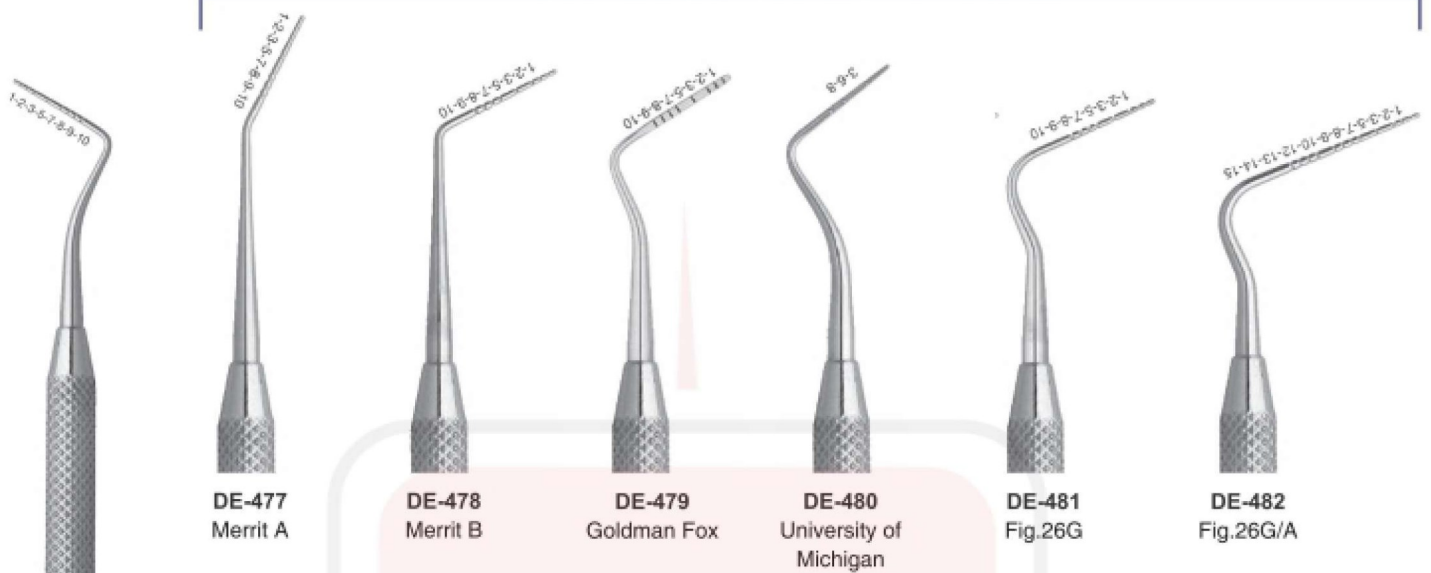

Pointed Probes Double Ended Handle 6mm, length 170mm

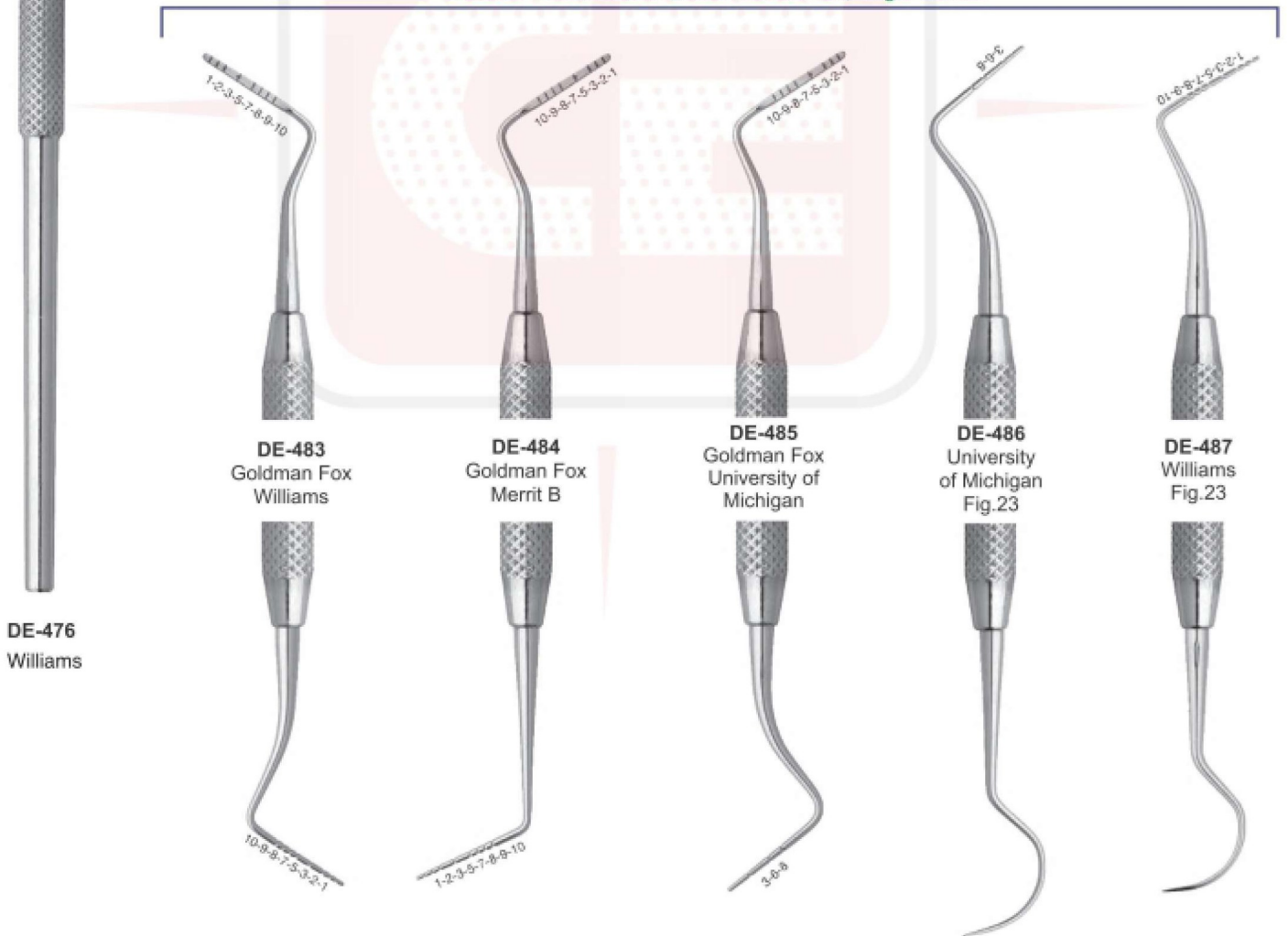

# PERIODONTAL INSTRUMENTS

- Инструменты пародонтологические
- Instruments pour la parodontologie
- Instrumente für die Parodontologie

- Інструменти пародонтологічні
- instrumentos para periodoncia
- الصكوك اللثة

PERIODONTAL SET OF 10 PIECES SOLID HANDLE 6MM LENGTH 170MM

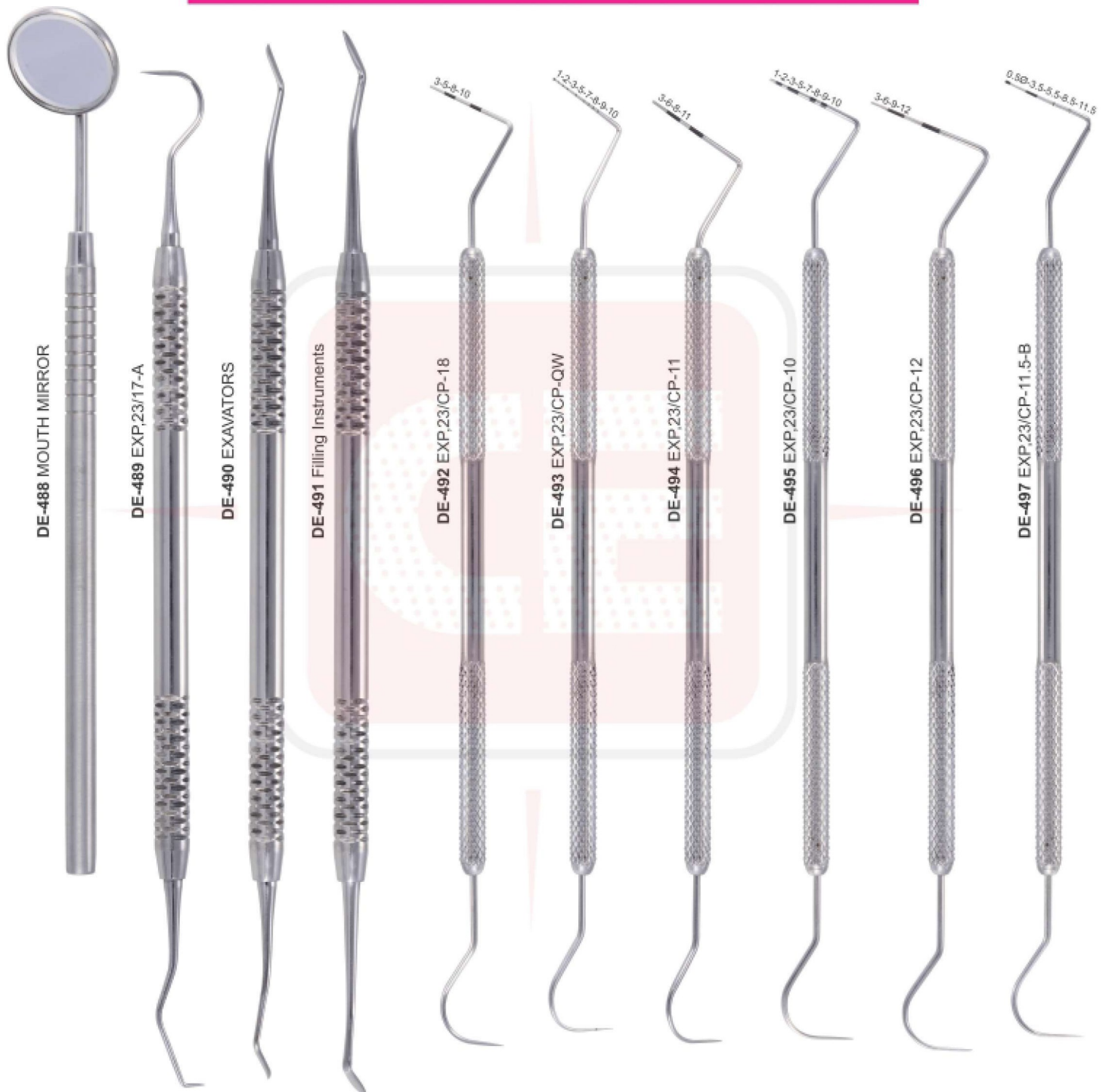

# EXPLORERS

- Зонды
- Sondes
- Zahnsonden
- Зонди
- Sondas
- المستكشفين

**WILLIAM PROBE SET DOUBLE ENDED WITH HOLLOW HANDLE 9.5MM, LENGTH 170MM  
CERAMIC COATED HANDLE**

Proper care must be given during cleaning, sharpening and sterilization to preserve design and integrity and to prolong usefulness. Do not expose instruments to sterilization temperatures above 350 F/177 C or to higher than recommended chemical concentrations.

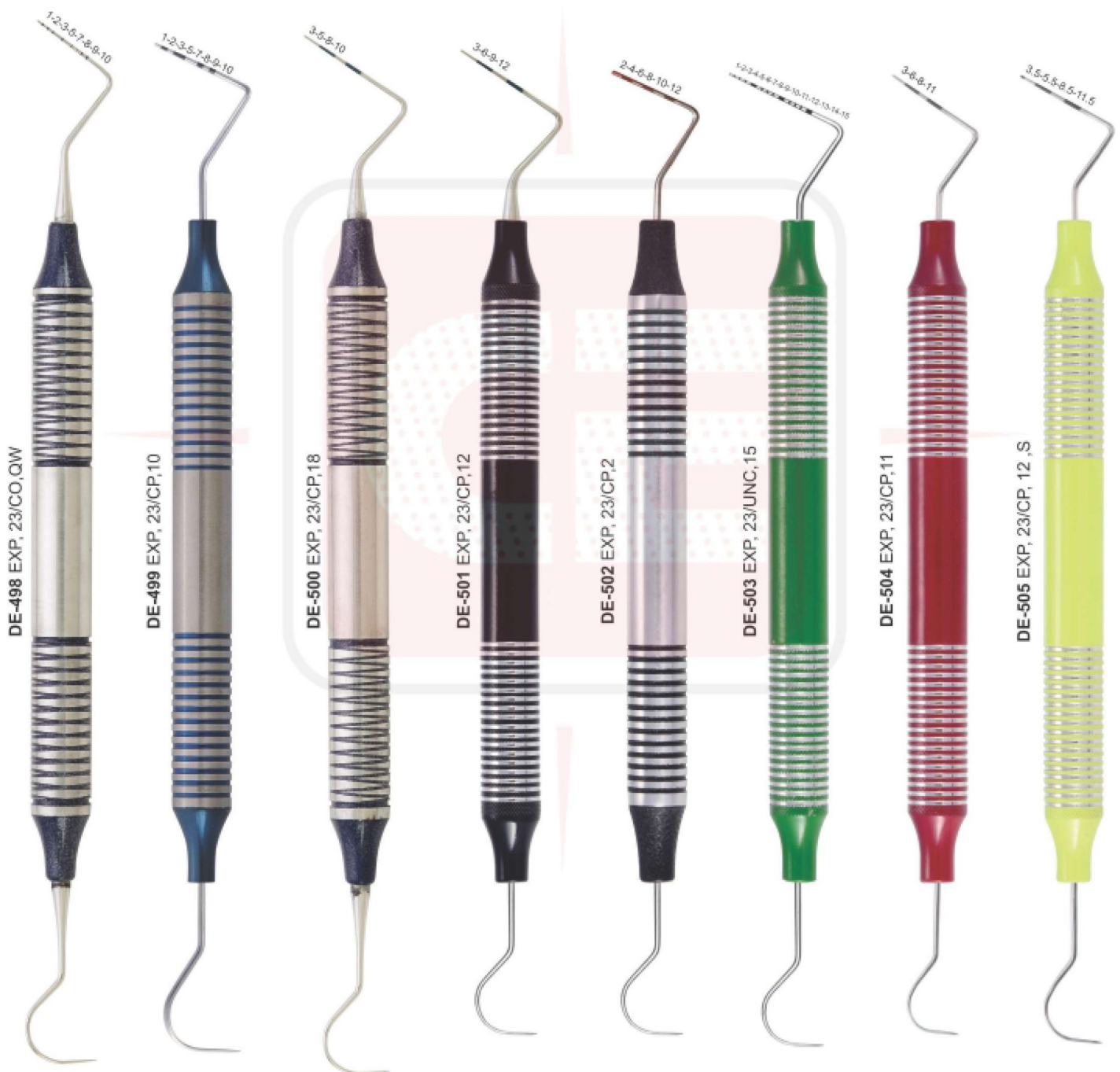

# PERIODONTAL INSTRUMENTS

- Инструменты пародонтологические
- Instruments pour la parodontologie
- Instrumente für die Parodontologie
- Інструменти пародонтологічні
- instrumentos para periodoncia
- الصكوك اللثة

**PERIODONTAL INSTRUMENTS SET OF 11 PCS  
SOLID HANDLE 6MM, LENGTH 170MM**

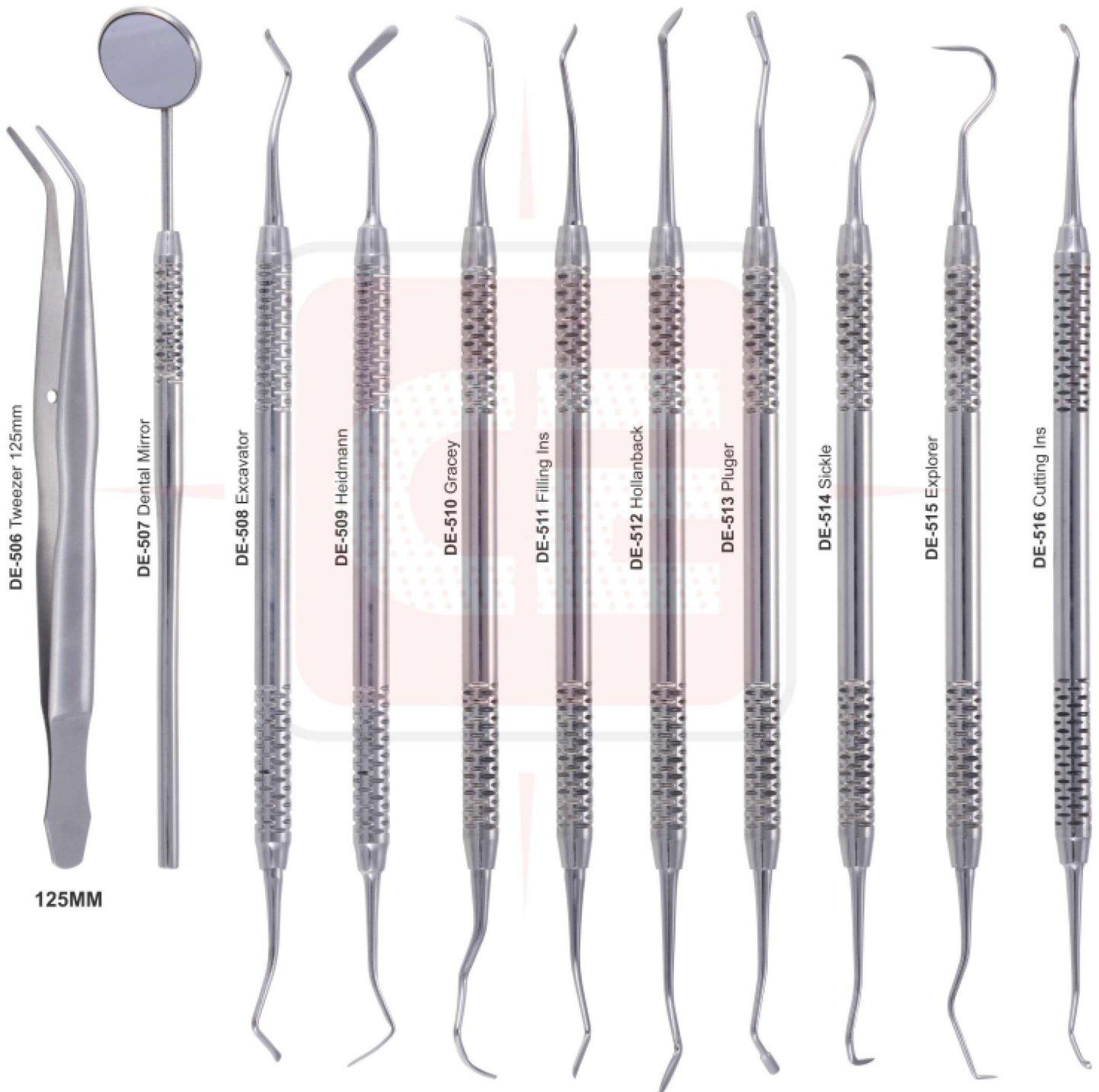

# CURETTES

- Кюрети
- Curetas
- Kuretten
- Кюрети
- Curette
- کرتس

GRACEY SET OF 7 PCS HOLLOW HANDLE 9.5MM, LENGTH 170MM

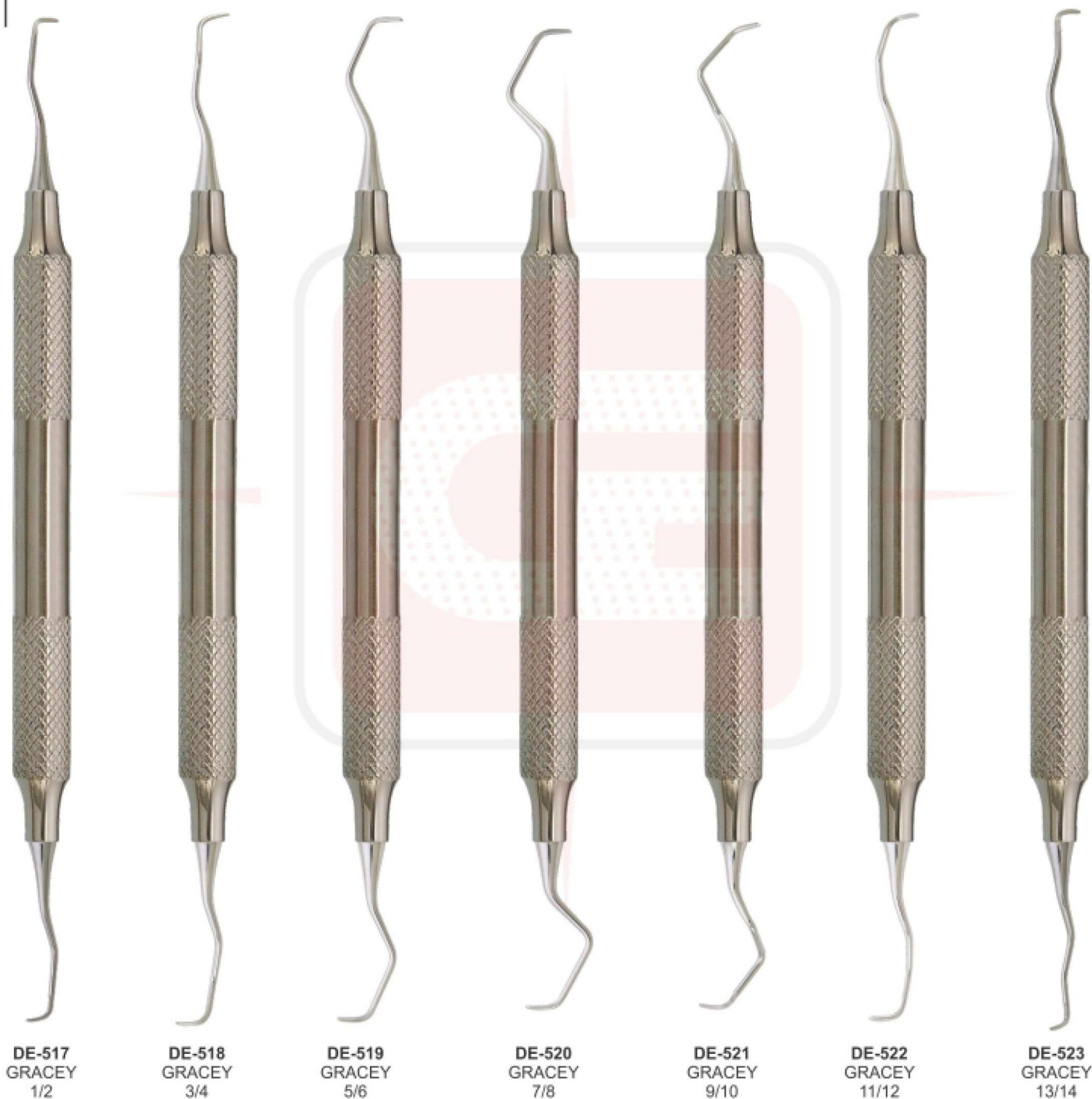

# CURETTES

- Кюрети
  - Curetas
  - Küretten
- Кюрети
  - Curette
  - كرتس

**GRACEY SET OF 7 PCS**  
**HOLLOW HANDLE 9.5MM, LENGTH 170MM WITH SILICON GRIP**

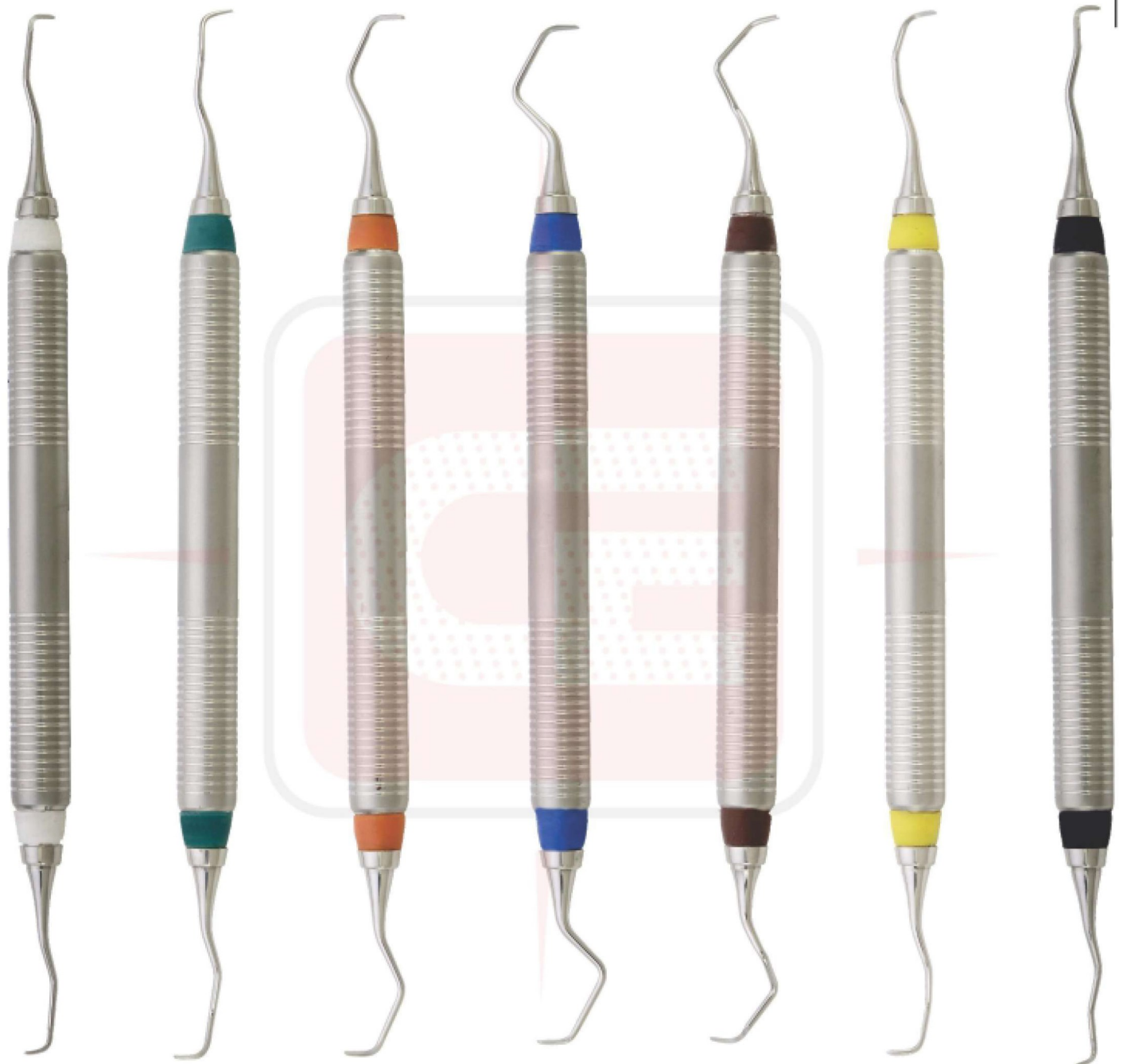

**DE-524**  
GRACEY  
1/2

**DE-525**  
GRACEY  
3/4

**DE-526**  
GRACEY  
5/6

**DE-527**  
GRACEY  
7/8

**DE-528**  
GRACEY  
9/10

**DE-529**  
GRACEY  
11/12

**DE-530**  
GRACEY  
13/14

# CURETTES

- Кюрети
- Curetas
- Küretten
- Кюрети
- Curette
- كرتس

## GRACEY MINI FIVE

HOLLOW HANDLE 9.5MM, LENGTH 170MM  
CERAMIC COATED HANDLE

## GRACEY AFTER FIVE

HOLLOW HANDLE 9.5MM, LENGTH 170MM  
CERAMIC COATED HANDLE

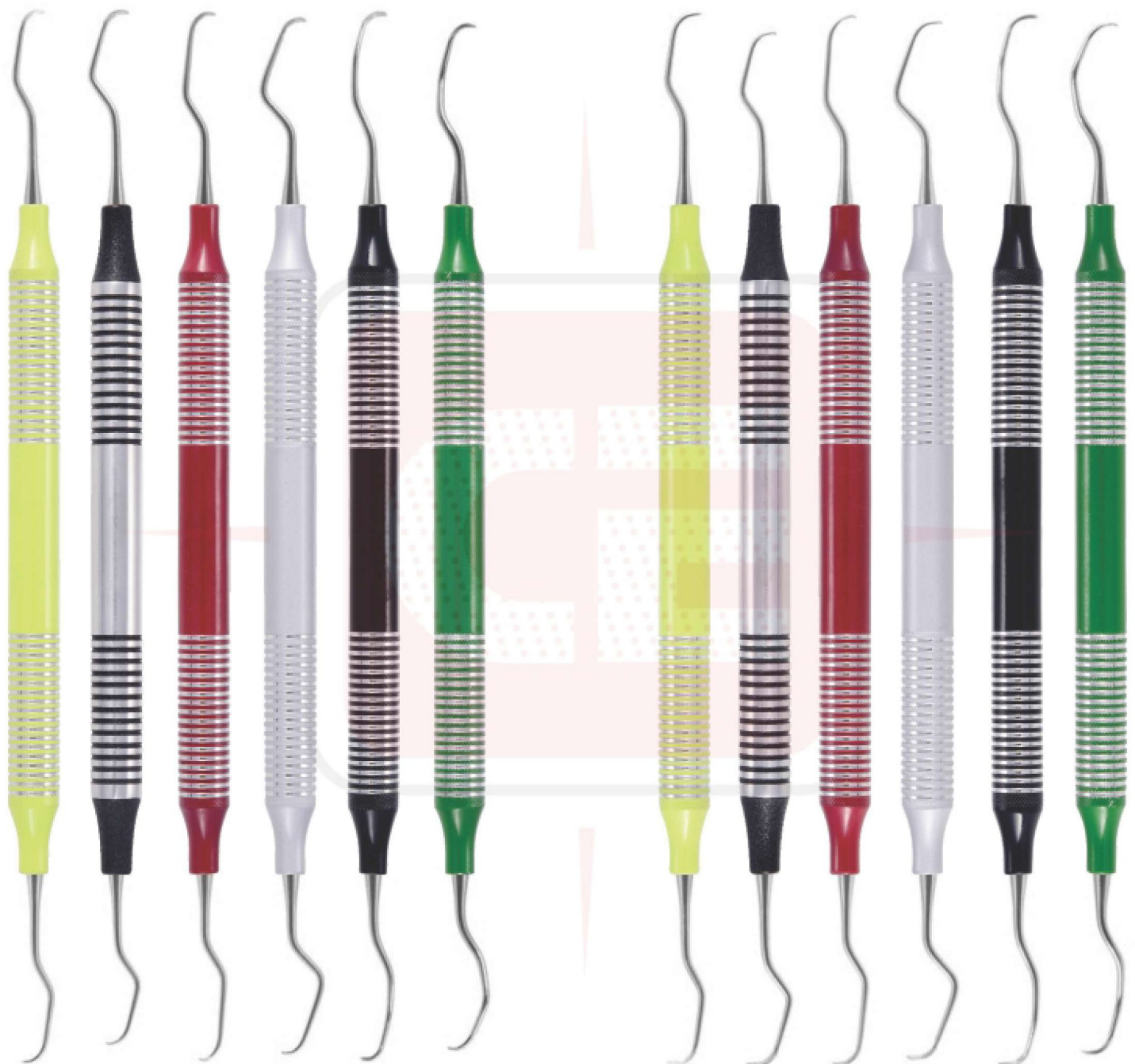

DE-531 Gracey 1/2  
DE-532 Gracey 3/4  
DE-533 Gracey 5/6  
DE-534 Gracey 7/8  
DE-535 Gracey 11/12  
DE-536 Gracey 13/14

DE-537 Gracey 1/2 AF  
DE-538 Gracey 3/4 AF  
DE-539 Gracey 5/6 AF  
DE-540 Gracey 7/8 AF  
DE-541 Gracey 11/12 AF  
DE-542 Gracey 13/14 AF

Proper care must be given during cleaning, sharpening and sterilization to preserve design and integrity and to prolong usefulness. Do not expose instruments to sterilization temperatures above 350 F/177 C or to higher than recommended chemical concentrations.

# CURETTES

- Кюрети
  - Curetas
  - Küretten
- Кюрети
  - Curette
  - کرتس

**GRACEY CURETTE  
HOLLOW HANDLE 10MM, LENGTH 170MM**

Curetters Set of 8 Pieces

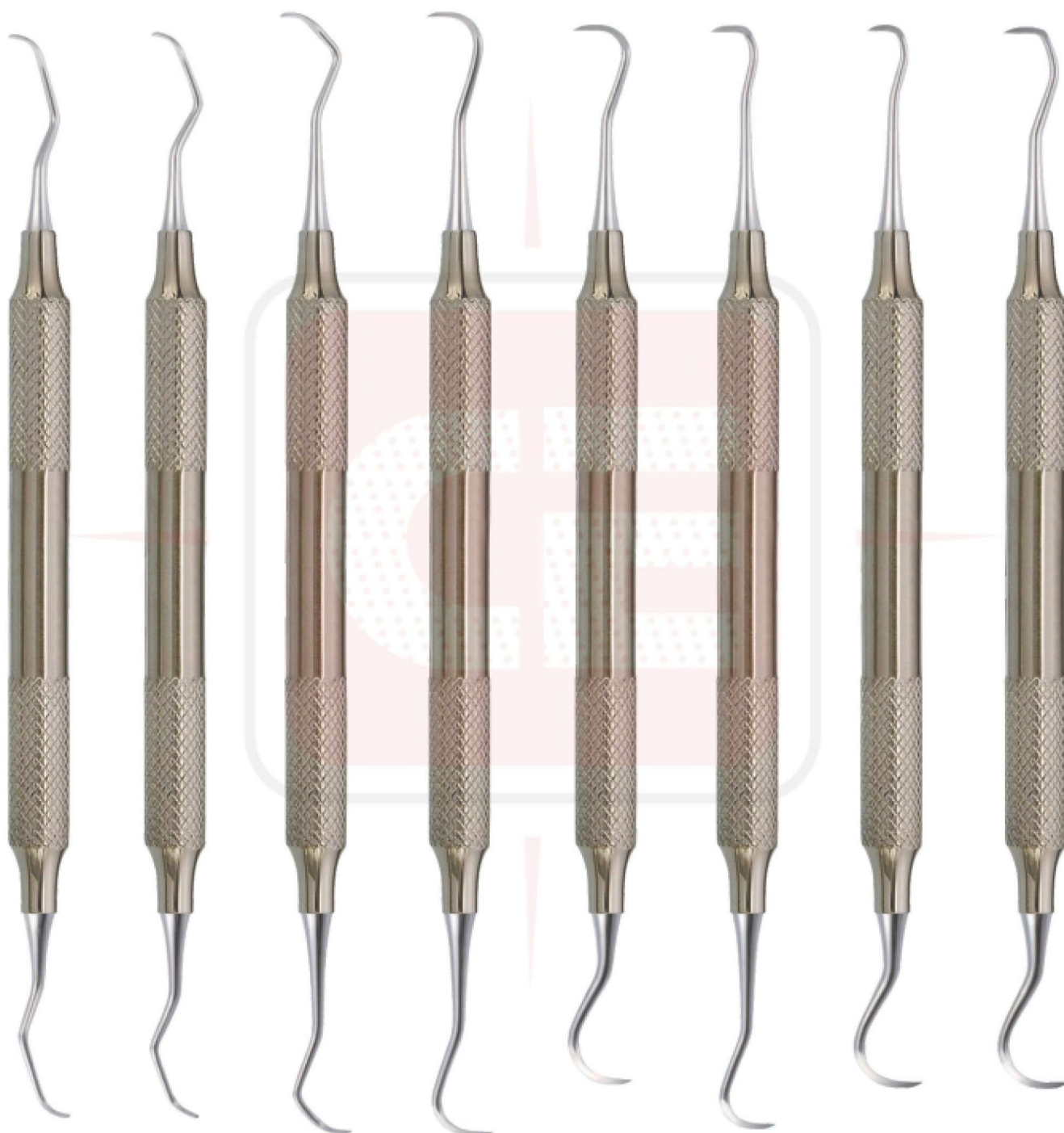

**DE-543**  
Curette  
Columbia  
2L-2R

**DE-544**  
Curette  
Columbia  
4L-4R

**DE-545**  
Curette  
McCall  
13S-14S

**DE-546**  
H6-H7  
Scaler  
Sickle

**DE-547**  
H5-U15  
Scaler  
Sickle

**DE-548**  
H5-13  
Scaler  
Sickle

**DE-549**  
U15-30  
Scaler  
Sickle

**DE-550**  
U15-33  
Scaler  
Sickle



# FILLING INSTRUMENTS

- Инструменты для реставрации
- Instruments pour plombage
- Füllungsinstrumente (mit Kontrawinkel)
- Инструменти для реставрації
- Instrumentos para obturaciones
- ملء الصكوك

**FILLING INSTRUMENTS (Gold Pointed)  
SOLID HANDLE 6MM, LENGTH 170MM**

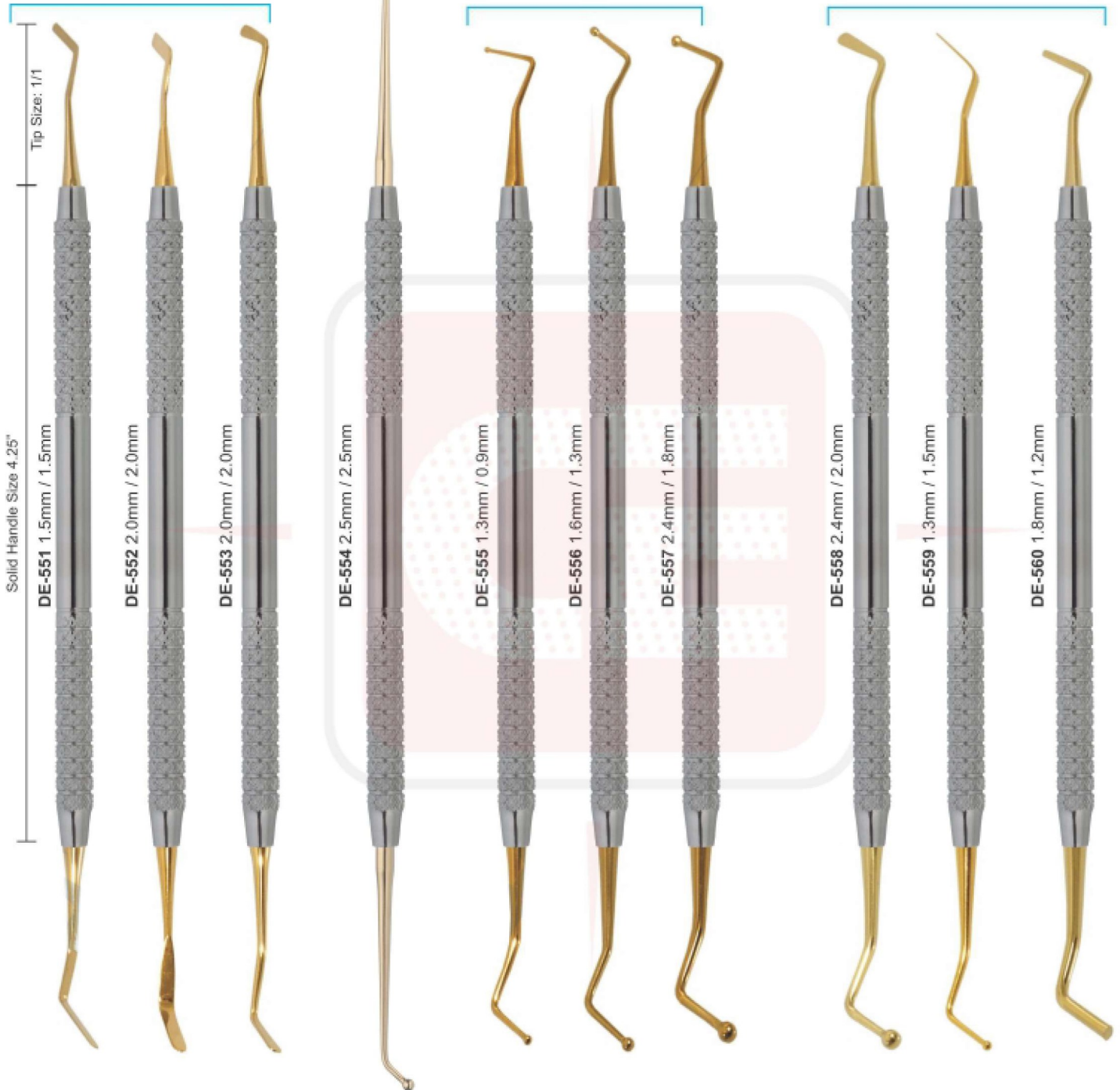

**Filling instrument,  
spatula 6 mm solid handle,  
length 170 mm,**

**Filling instrument  
6 mm  
length 175 mm,**

**Filling instrument,  
ball 6 mm  
length 170 mm,**

**Filling instrument,  
ball / spatula  
6 mm  
length 175 mm,**

**Filling instrument,  
plan / plan 6 mm  
length 165 mm,**

# EXPLORERS

EXPLORERS INSTRUMENTS  
SOLID HANDLE 6MM, LENGTH 170MM

- Зонды
- Зонди
- Sondes
- Sondas
- Zahnsonden
- المستكشفين

## PLUGGERS

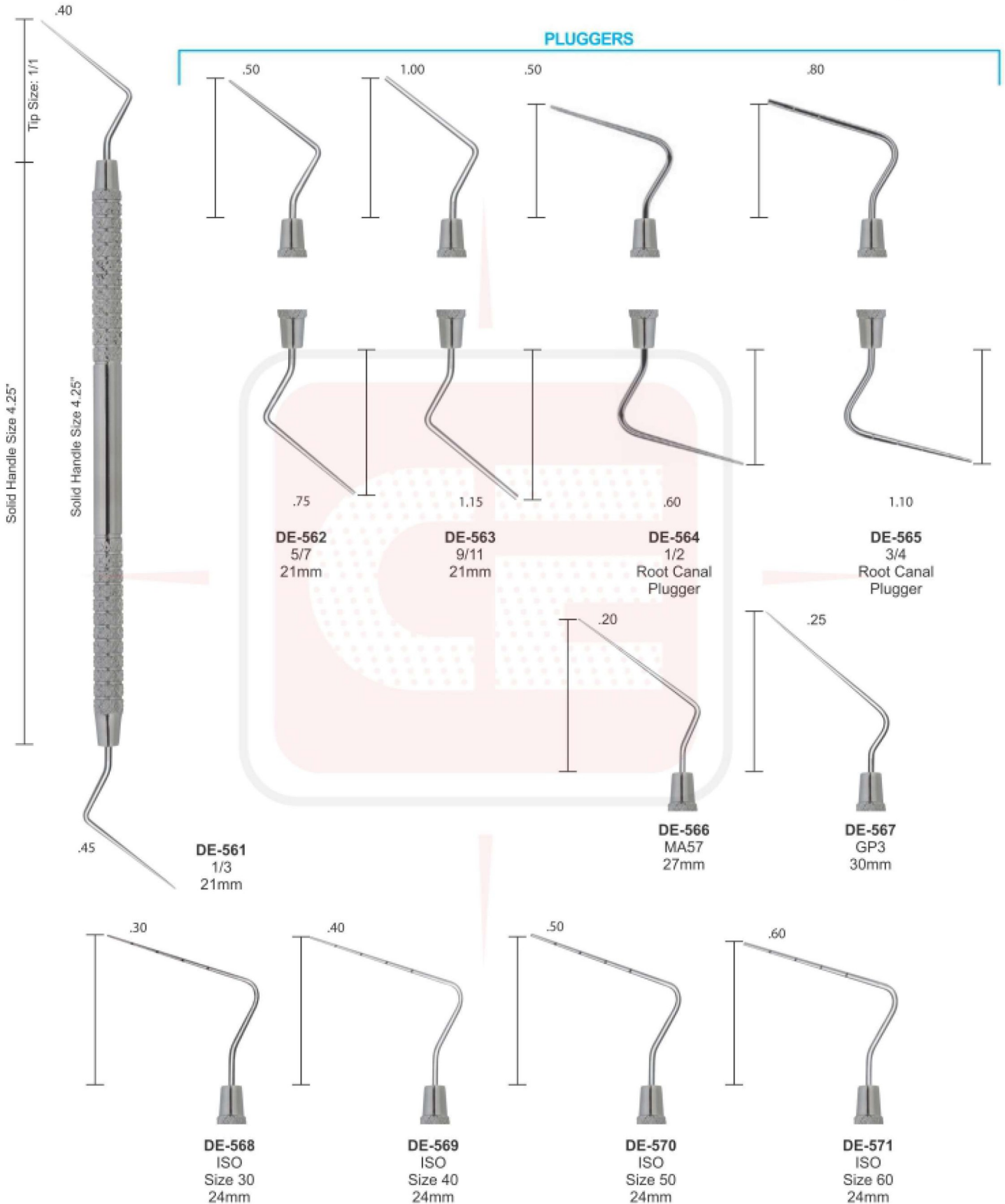

# PERIODONTAL PROBES

- Зонды пародонтологические
- Sondes parodontales
- sonda parodontali
- зонди пародонтологічні
- Sondas parodontales
- المسبار اللثة

## SPREADERS

## HEAT CARRIERS

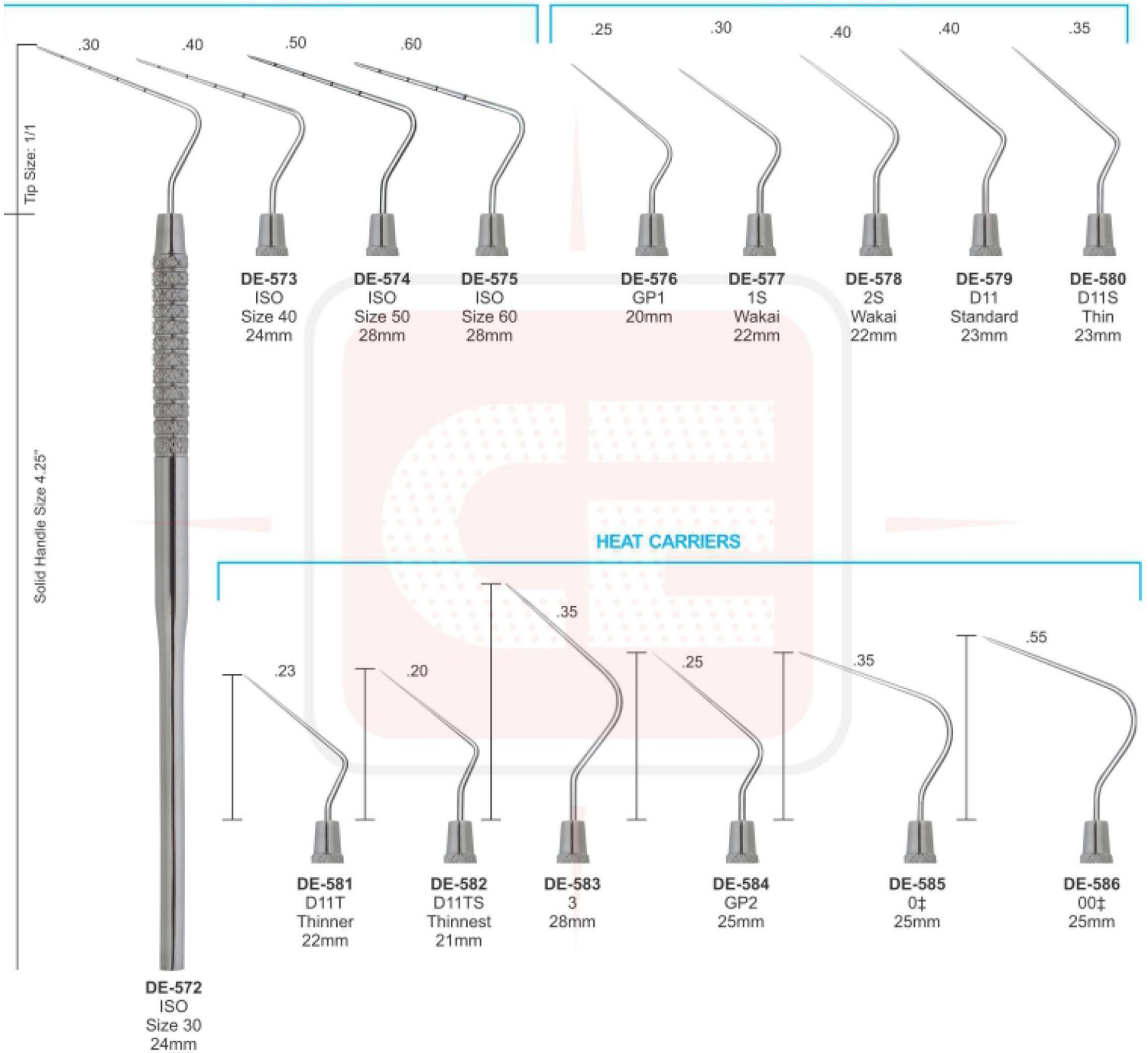

# PERIODONTAL PROBES

- Зонды пародонтологические
- зонди пародонтологічні
- Sondes paradontales
- Sondas paradontales
- sonde parodontali
- المسابر اللثة

## ENDODONTICS INSTRUMENTS

### ANTERIOR

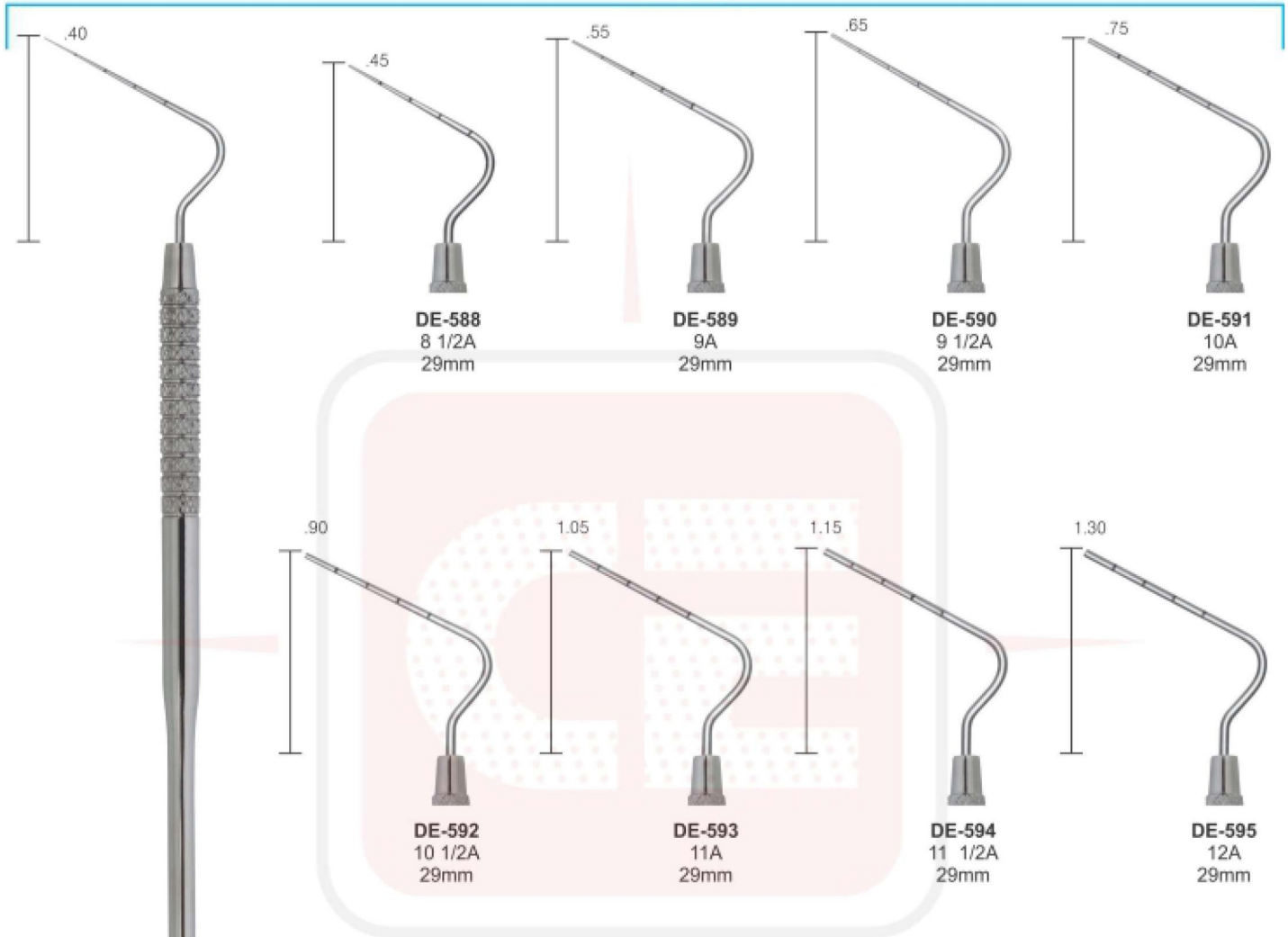

### LUKS



# PERIODONTAL PROBES

- Зонды пародонтологические
- Sondas paradontales
- sonda parodontali
- зонди пародонтологічні
- Sondas paradontales
- المسابير اللثة

**ENDODONTICS INSTRUMENTS SOLID HANDLE 6MM, LENGTH 170MM**  
**POSTERIOR**

**RETRO FILLING PLUGGERS**

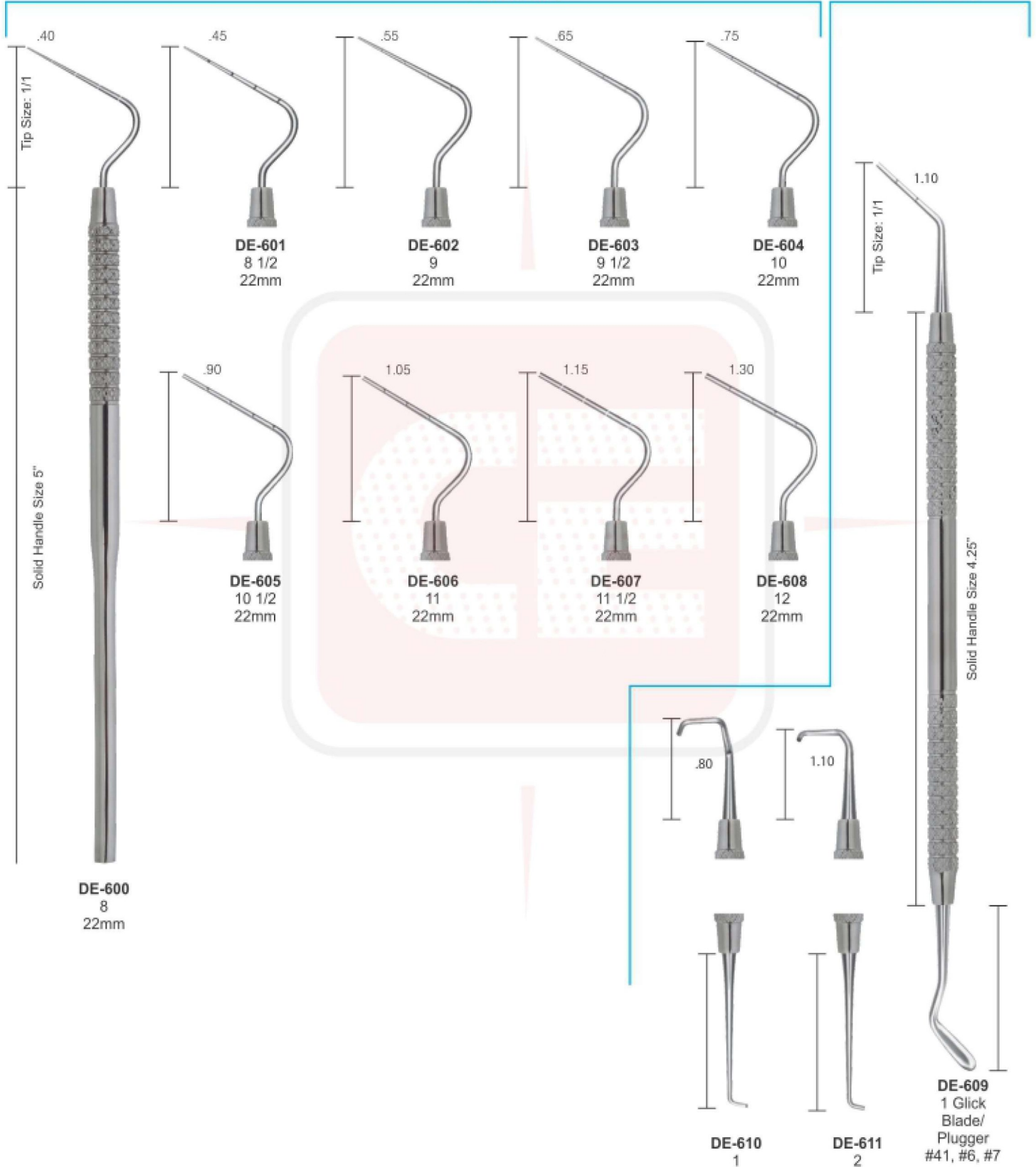

# FILLING INSTRUMENTS

- Инструменты для реставрации
- Instruments pour plombage
- Füllungsinstrumente (mit Kontrawinkel)
- Инструменти для реставрації
- Instrumentos para obturaciones
- ملء الصكوك

**COMPOSITE/PLASTIC FILLING INSTRUMENTS SOLID HANDLE 6MM, LENGTH 170MM**

**POSTERIOR**

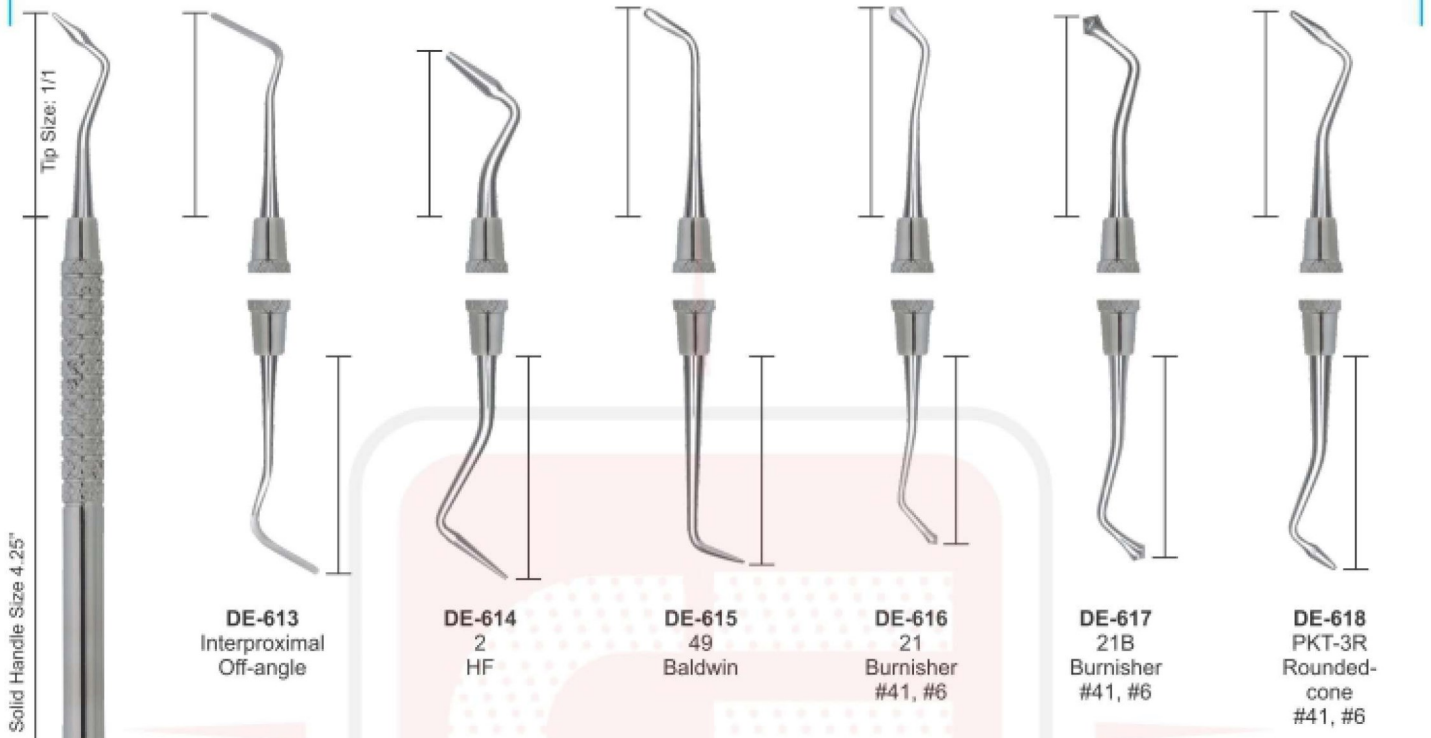

**UNIVERSAL FILLING INSTRUMENTS**

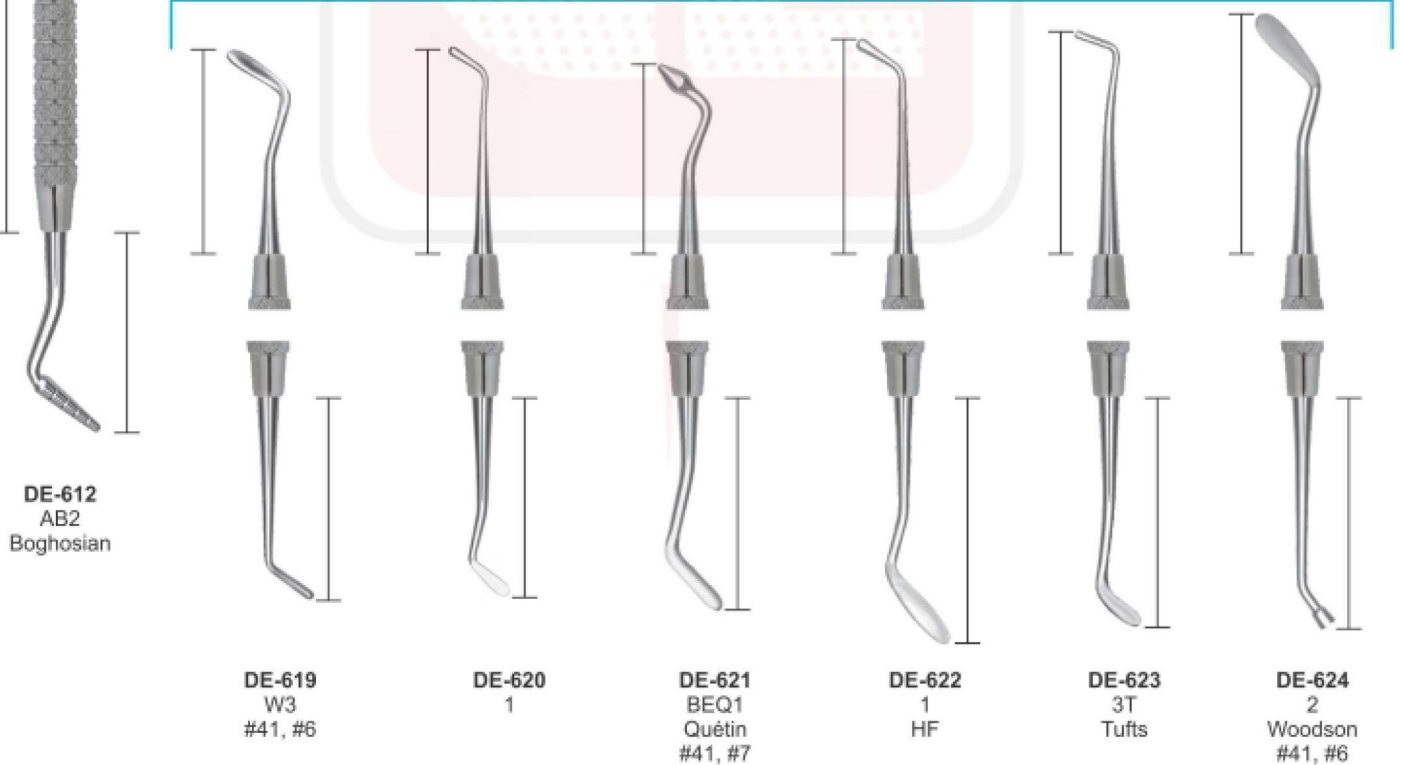

# FILLING INSTRUMENTS

- Инструменты для реставрации
- Instruments pour plombage
- Füllungsinstrumente (mit Kontrawinkel)
- Инструменти для реставрації
- Instrumentos para obturaciones
- ملء الصكوك

**COMPOSITE/PLASTIC FILLING INSTRUMENTS SOLID HANDLE 6MM, LENGTH 170MM**  
**BLACK PLUGGERS/CONDENSERS Hollenback**

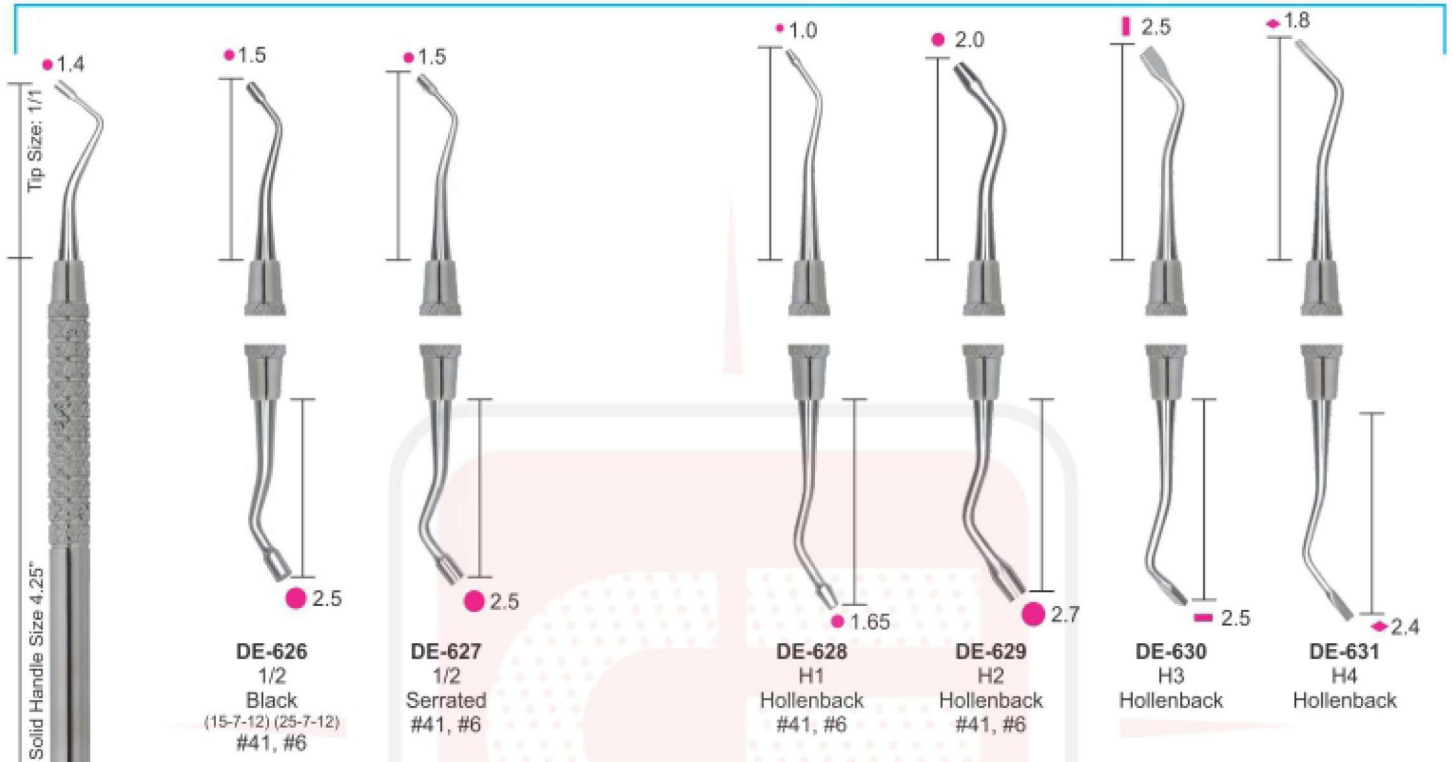

**MARQUETTE CONDENSER**

**MORTONSON**

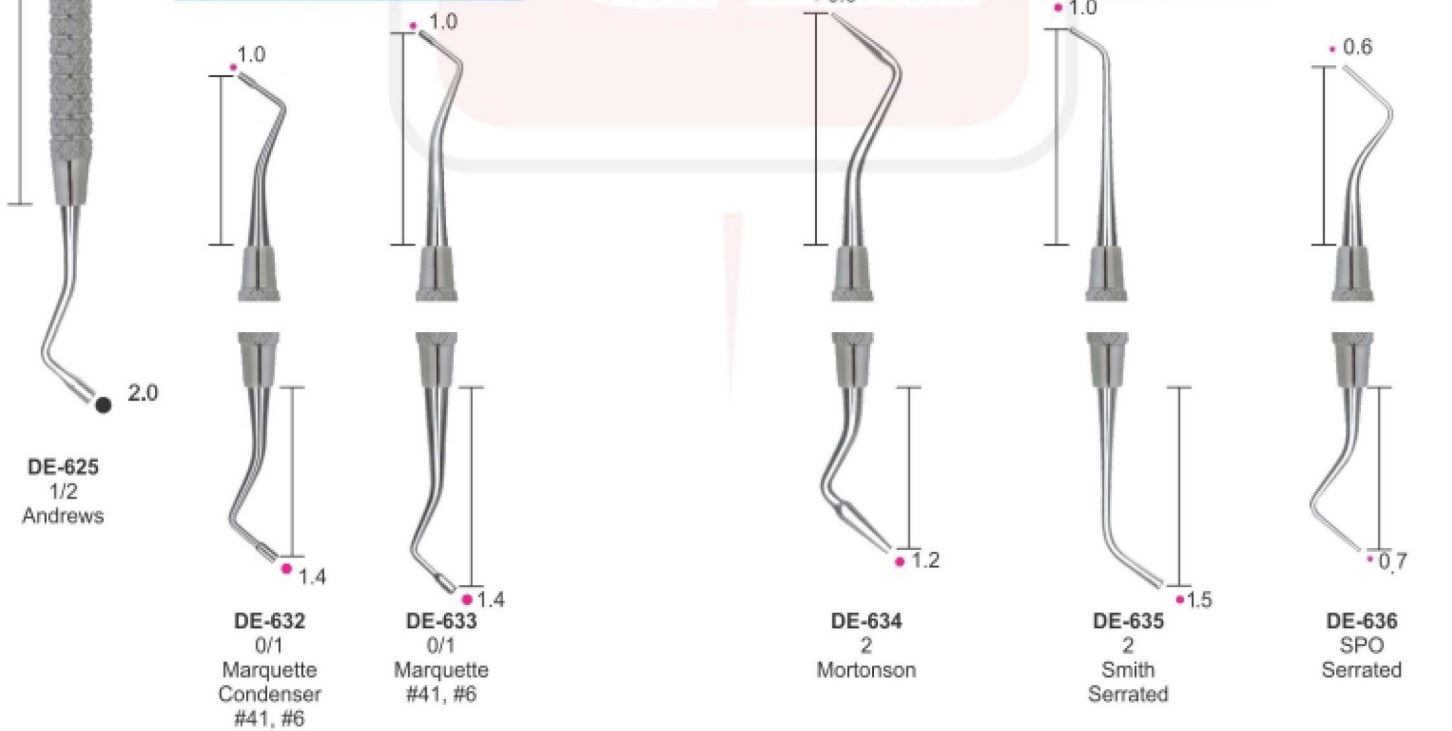

# FILLING INSTRUMENTS

- Инструменты для реставрации
- Instruments pour plombage
- Füllungsinstrumente (mit Kontrawinkel)
- Инструменти для реставрації
- Instrumentos para obturaciones
- ملء الصكوك

## PLUGGERS/CONDENSERS

## RESTORATIVE INSTRUMENTS SOLID HANDLE 6MM, LENGTH 170MM

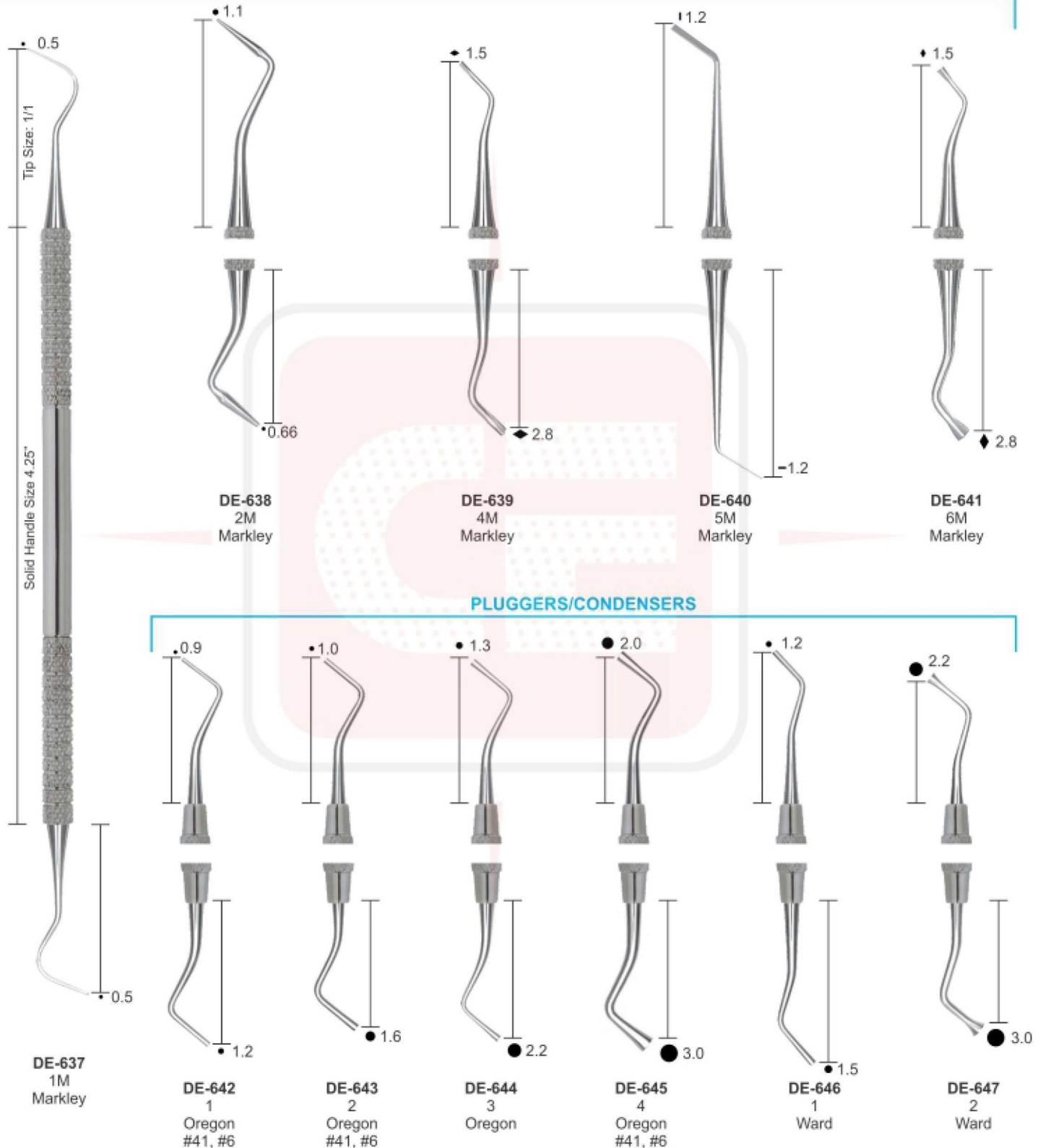



# FILLING INSTRUMENTS

- Инструменты для реставрации
- Instruments pour plombage
- Füllungsinstrumente (mit Kontrawinkel)
- Инструменти для реставрації
- Instrumentos para obturaciones
- ملء الصكوك

RESTORATIVE INSTRUMENTS SOLID HANDLE 6MM, LENGTH 170MM

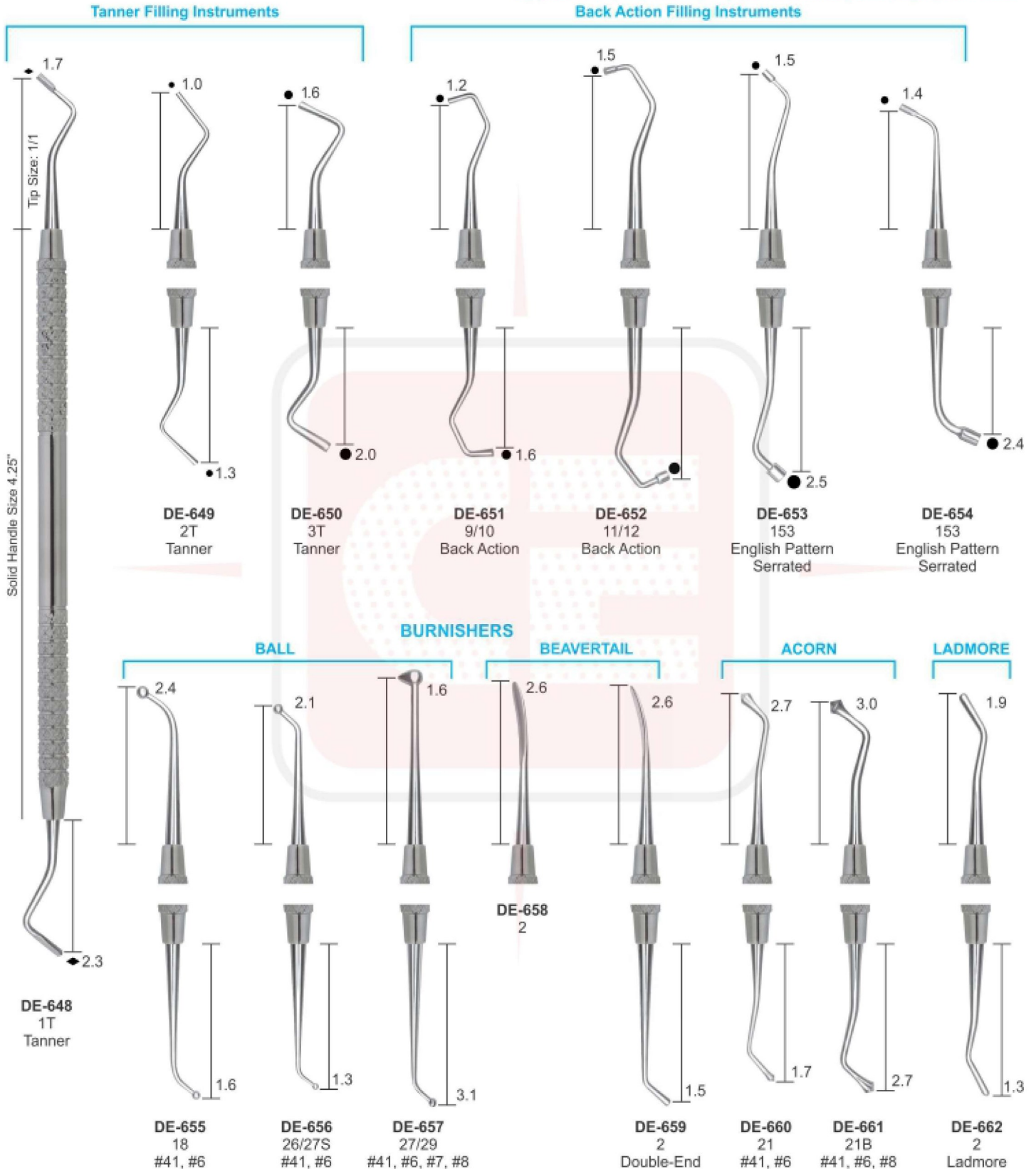

**Tanner Filling Instruments**

- DE-649 2T Tanner (Tip Size: 1/1, Solid Handle Size: 4.25)
- DE-650 3T Tanner (Tip Size: 1.0)
- DE-655 18 #41, #6 (Tip Size: 2.4)
- DE-656 26/27S #41, #6 (Tip Size: 2.1)
- DE-657 27/29 #41, #6, #7, #8 (Tip Size: 1.6)

**Back Action Filling Instruments**

- DE-651 9/10 Back Action (Tip Size: 1.2)
- DE-652 11/12 Back Action (Tip Size: 1.5)
- DE-653 153 English Pattern Serrated (Tip Size: 1.5)
- DE-654 153 English Pattern Serrated (Tip Size: 1.4)

**BURNISHERS**

- DE-658 2 (Tip Size: 1.6)

**BEAVERTAIL**

- DE-659 2 Double-End (Tip Size: 2.6)

**ACORN**

- DE-660 21 #41, #6 (Tip Size: 2.7)
- DE-661 21B #41, #6, #8 (Tip Size: 3.0)

**LADMORE**

- DE-662 2 Ladmore (Tip Size: 1.9)

**Other Instruments:**

- DE-648 1T Tanner (Tip Size: 2.3)
- DE-655 18 #41, #6 (Tip Size: 1.6)
- DE-656 26/27S #41, #6 (Tip Size: 1.3)
- DE-657 27/29 #41, #6, #7, #8 (Tip Size: 3.1)
- DE-659 2 Double-End (Tip Size: 1.5)
- DE-660 21 #41, #6 (Tip Size: 1.7)
- DE-661 21B #41, #6, #8 (Tip Size: 2.7)
- DE-662 2 Ladmore (Tip Size: 1.3)

# FILLING INSTRUMENTS

- Инструменты для реставрации
- Instruments pour plombage
- Füllungsinstrumente (mit Kontrawinkel)
- Інструменти для реставрації
- Instrumentos para obturaciones
- ملء الصكوك

RESTORATIVE INSTRUMENTS SOLID HANDLE 6MM, LENGTH 170MM

## BURNISHERS

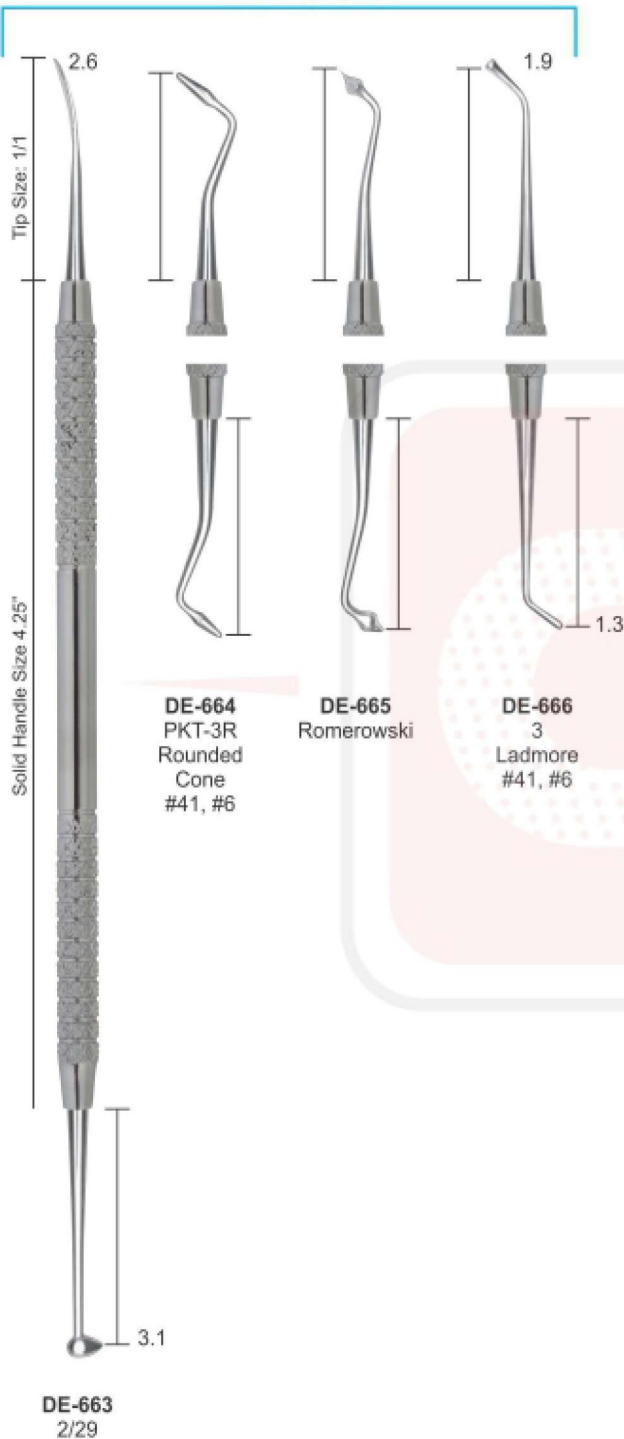

## PERIODONTAL FILES

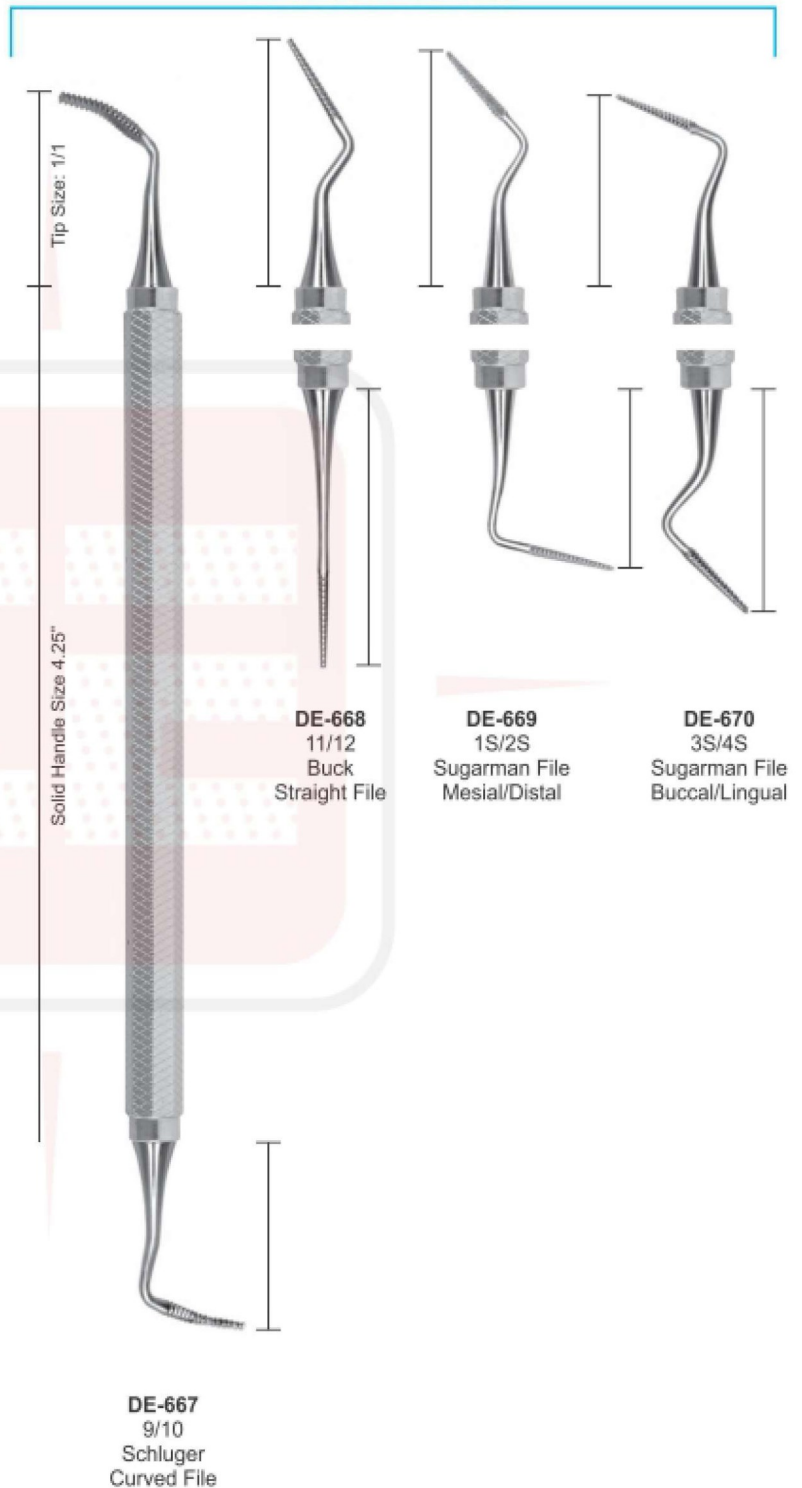

# FILLING INSTRUMENTS

- Инструменты для реставрации
- Instruments pour plombage
- Füllungsinstrumente (mit Kontrawinkel)
- Инструменти для реставрації
- Instrumentos para obturaciones
- ملء الصكوك

COMPOSITE/PLASTIC FILLING INSTRUMENTS  
SOLID HANDLE 6MM, LENGTH 170MM

## BURNISHER FILLING INSTRUMENTS

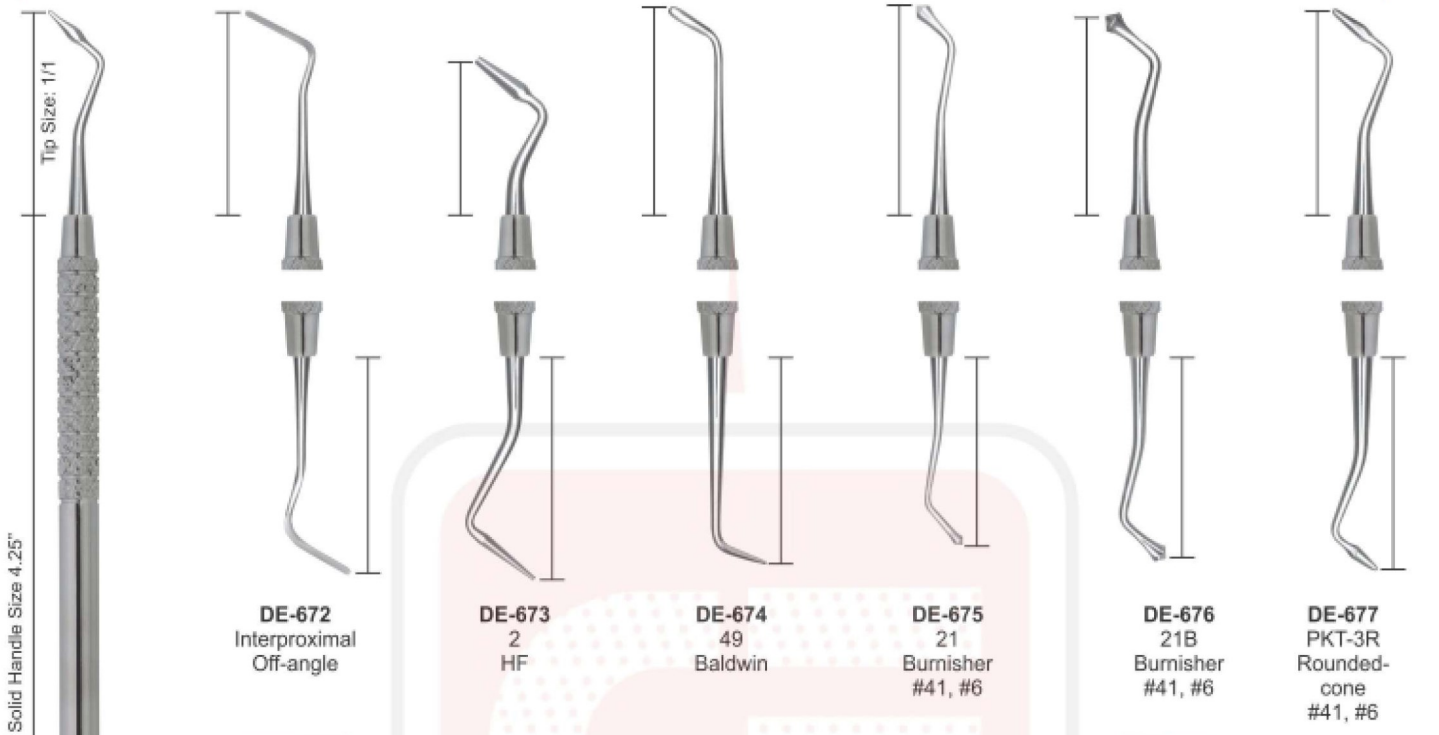

## UNIVERSAL FILLING INSTRUMENTS

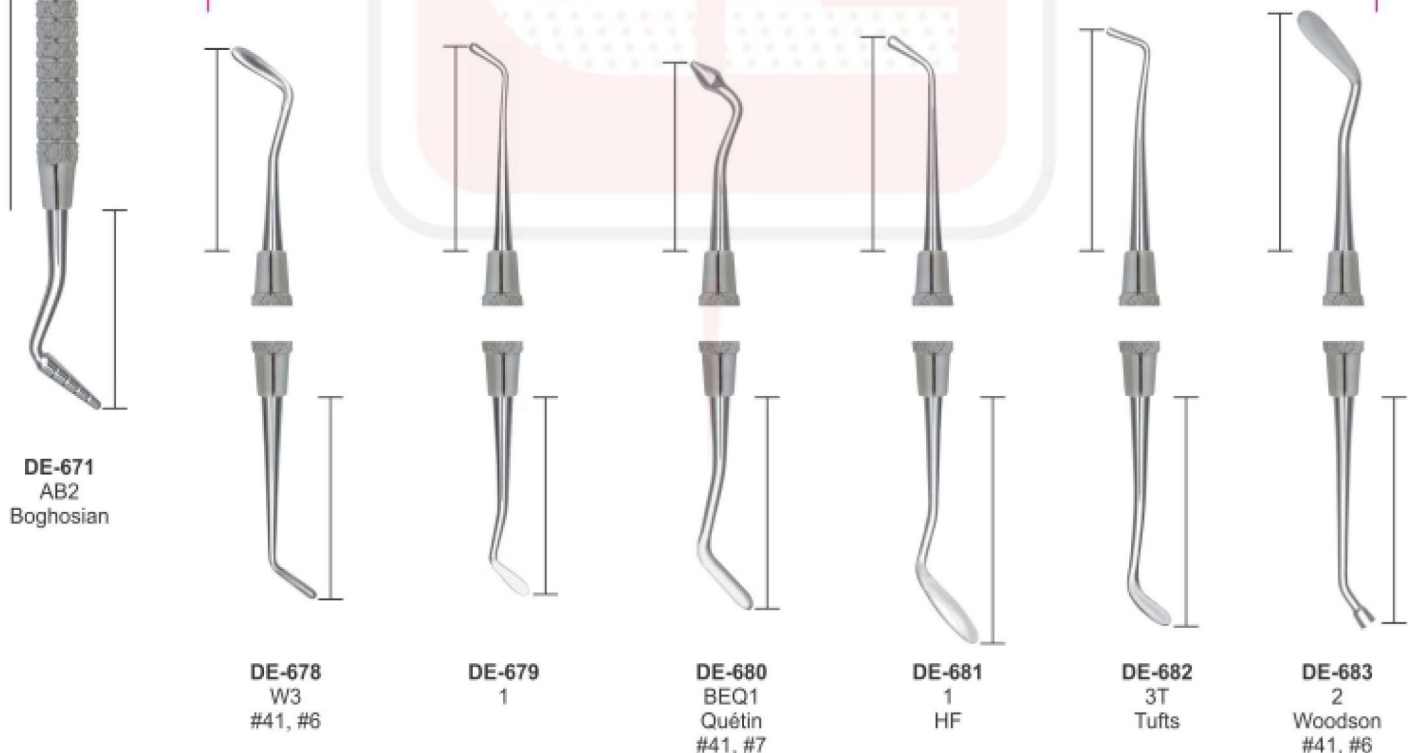

# FILLING INSTRUMENTS

- Инструменты для реставрации
- Instruments pour plombage
- Füllungsinstrumente (mit Kontrawinkel)
- Инструменти для реставрації
- Instrumentos para obturaciones
- ملء الصكوك

## FILLING INSTRUMENTS SOLID HANDLE 6MM, LENGTH 170MM



# AMALGAM CARVERS

- Инструменты для реставрации
- Instruments pour amalgame
- Amalgampistolen

- Инструменти для реставрації
- instrumentos para amalgama
- تقطيع المنغم

## AMALGAM INSTRUMENTS SOLID HANDLE 6MM, LENGTH 170MM

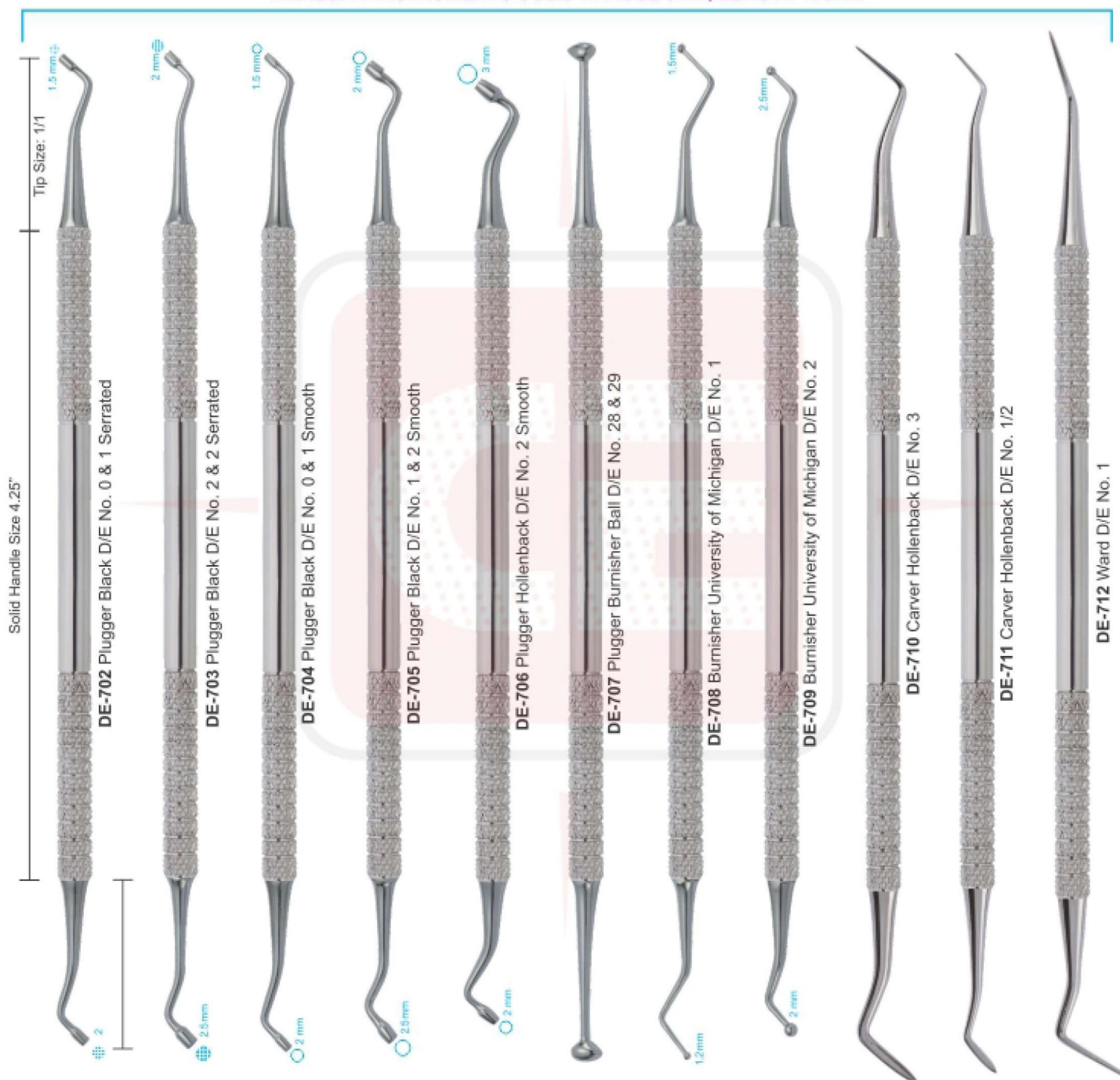

# AMALGAM CARVERS

- Инструменты для реставрации
- Instruments pour amalgame
- Amalgampistolen

- Інструменти для реставрації
- instrumentos para amalgama
- تقطيع الملعق

AMALGAM INSTRUMENTS  
SOLID HANDLE 6MM, LENGTH 170MM

## Excavators Instruments Set of 11 Pieces

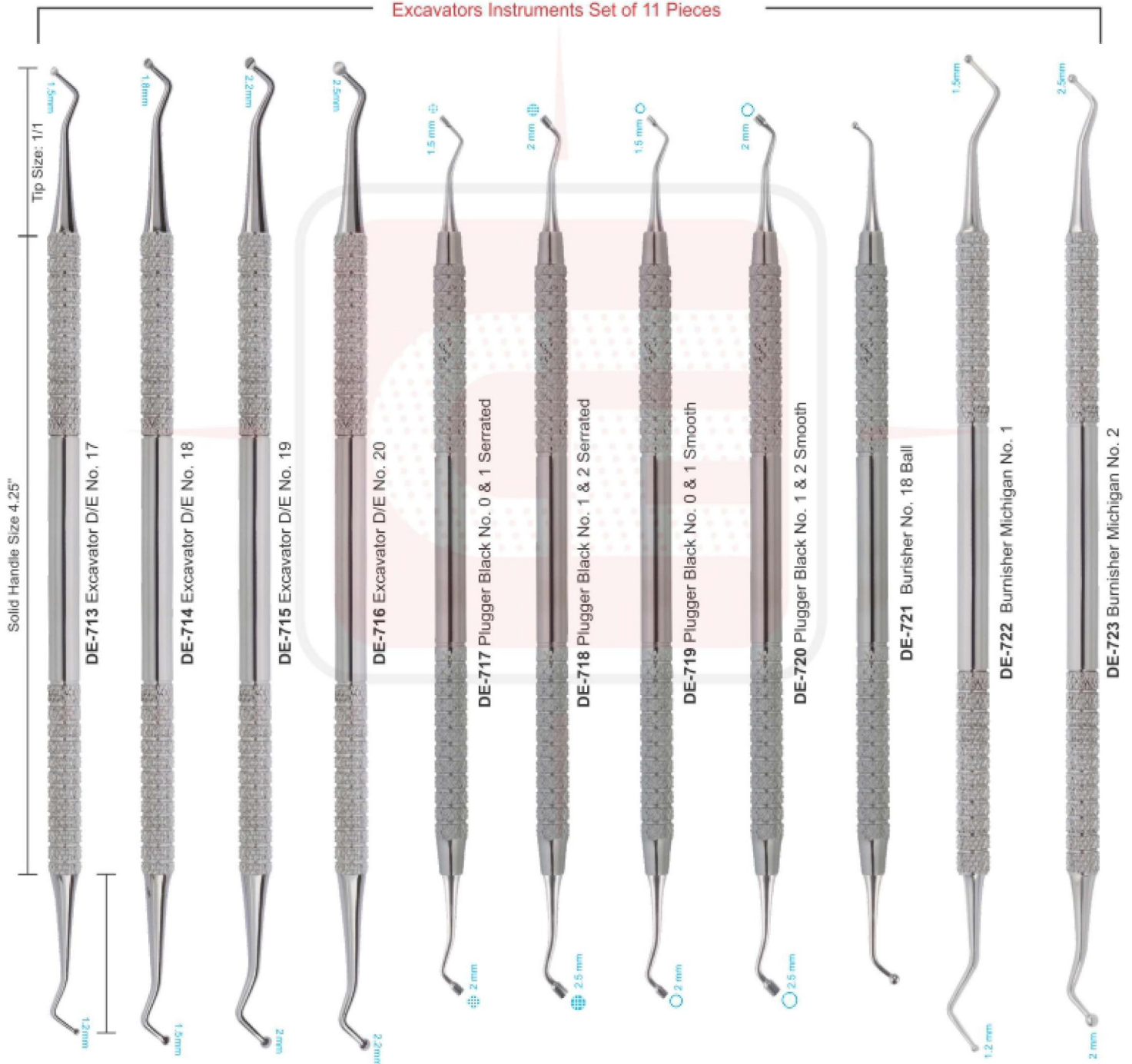

# PERIODONTAL INSTRUMENTS

- Инструменты пародонтологические
- Instruments pour la parodontologie
- Instrumente für die Parodontologie
- Инструменти пародонтологічні
- instrumentos para periodoncia
- الصكوك اللثة

## SICKLE SCALERS INSTRUMENTS SOLID HANDLE 6MM, LENGTH 170MM

### SICKLE SCALERS



**DE-724**  
H6/H7†  
Hygienist  
#2, #4, #6,  
#7, #8, #9

**DE-725**  
6/7  
Goldman  
#2, #4, #6,  
#7, #8

**DE-726**  
U15  
Towner  
#24, #6,  
#7, #8

**DE-727**  
H5/U15  
Hygienist-  
Towner  
#2, #4, #6

**DE-728**  
U15/30  
Towner-  
Jacquette  
#2, #4, #6  
#7, #8, #9

**DE-729**  
H15/33†  
Hygienist-  
Jacquette  
#2, #4, #6  
#7, #8, #9

**DE-730**  
U15/33  
Towner-  
Jacquette  
#2, #4, #6  
#7, #8, #9

# PERIODONTAL INSTRUMENTS

- Инструменты пародонтологические
- Инструменти пародонтологічні
- Instruments pour la parodontologie
- instrumentos para periodoncia
- Instrumente für die Parodontologie
- المسكوك اللثة

PERIODONTAL INSTRUMENTS SOLID HANDLE 6MM, LENGTH 170MM

## JACQUETTE SCALERS

## CRANE-KAPLAN



**DE-731**  
30/33  
Hygienist  
Jacquette  
#2, #4, #6,  
#7, #8, #9

**DE-732**  
31/32  
Jacquette  
#2, #4, #6,  
#7, #8, #9

**DE-733**  
34/35  
Jacquette  
#2, #4, #6,  
#7, #8, #9

**DE-734**  
H3/H4  
Jacquette  
#2, #4, #6,

**DE-735**  
14/15  
Posterior  
Jacquette  
#2, #4, #6,

**DE-736**  
CK-6  
#2, #4, #6,



# PERIODONTAL INSTRUMENTS

- Инструменты пародонтологические
- Instruments pour la parodontologie
- Instrumente für die Parodontologie
- Инструменти пародонтологічні
- instrumentos para periodoncia
- الصكوك اللثة

## PERIODONTAL INSTRUMENTS SOLID HANDLE 6MM, LENGTH 170MM SCALER/CURETTE SETS

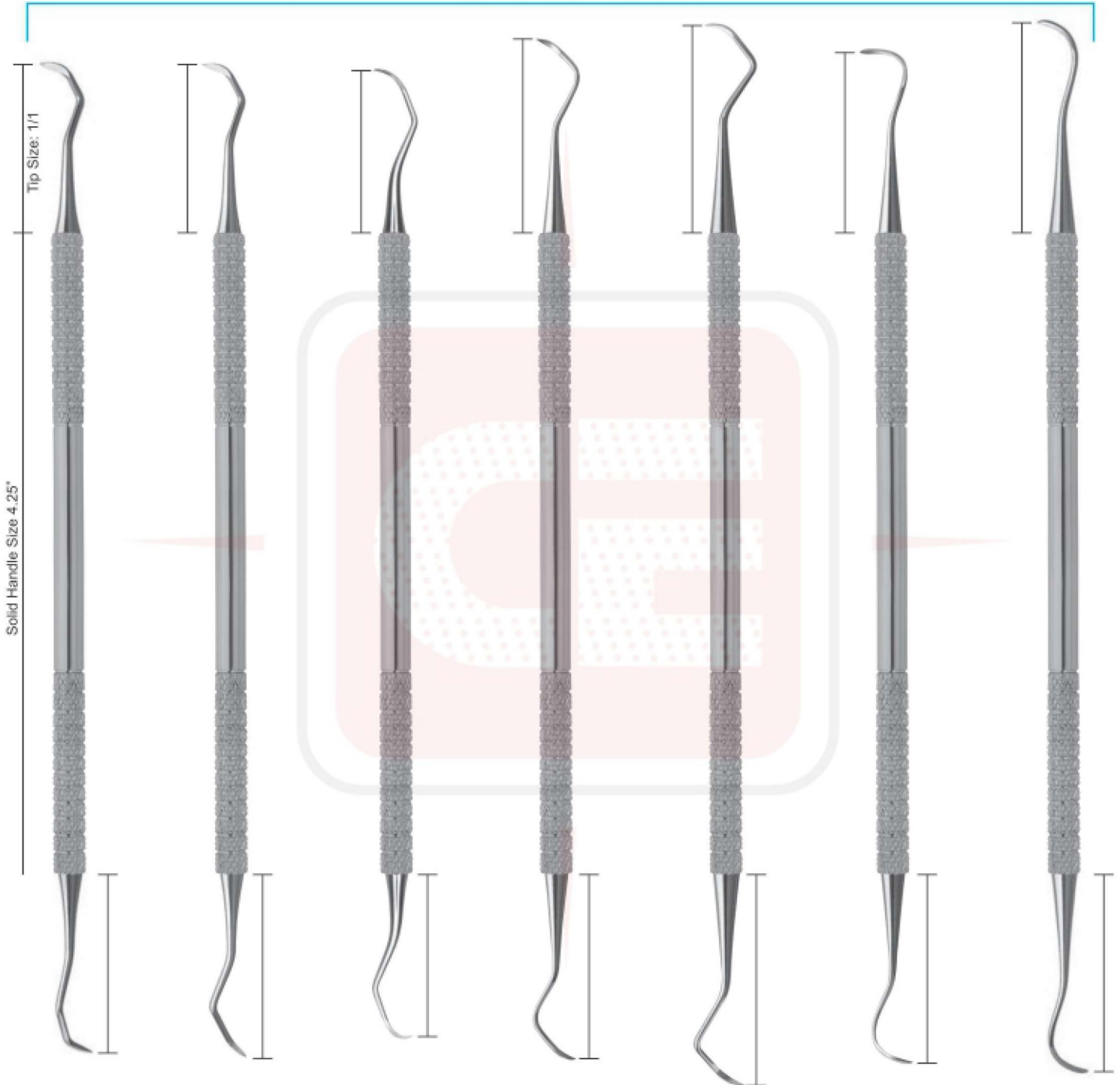

**DE-737**  
11/12  
Scaler  
#2, #6,  
#7, #8

**DE-738**  
11A/12A  
Scaler  
#2, #4, #6,

**DE-739**  
11/12S  
Modied  
McCall  
#4, #6

**DE-740**  
13S/14S  
Pointed  
Curette  
#2, #4, #6  
#7, #8, #9

**DE-741**  
MTC 13/14  
Pointed  
Curette  
#4, #6

**DE-742**  
17S/18S  
Curette  
#2, #4, #6  
#7, #8, #9

**DE-743**  
19/20  
Curette  
#2

# CURETTES

- Кюрети
  - Curetas
  - Küretten
- Кюрети
  - Curette
  - کرتس

## SCALER/CURETTE SETS

## GOLDMAN-FOX SET

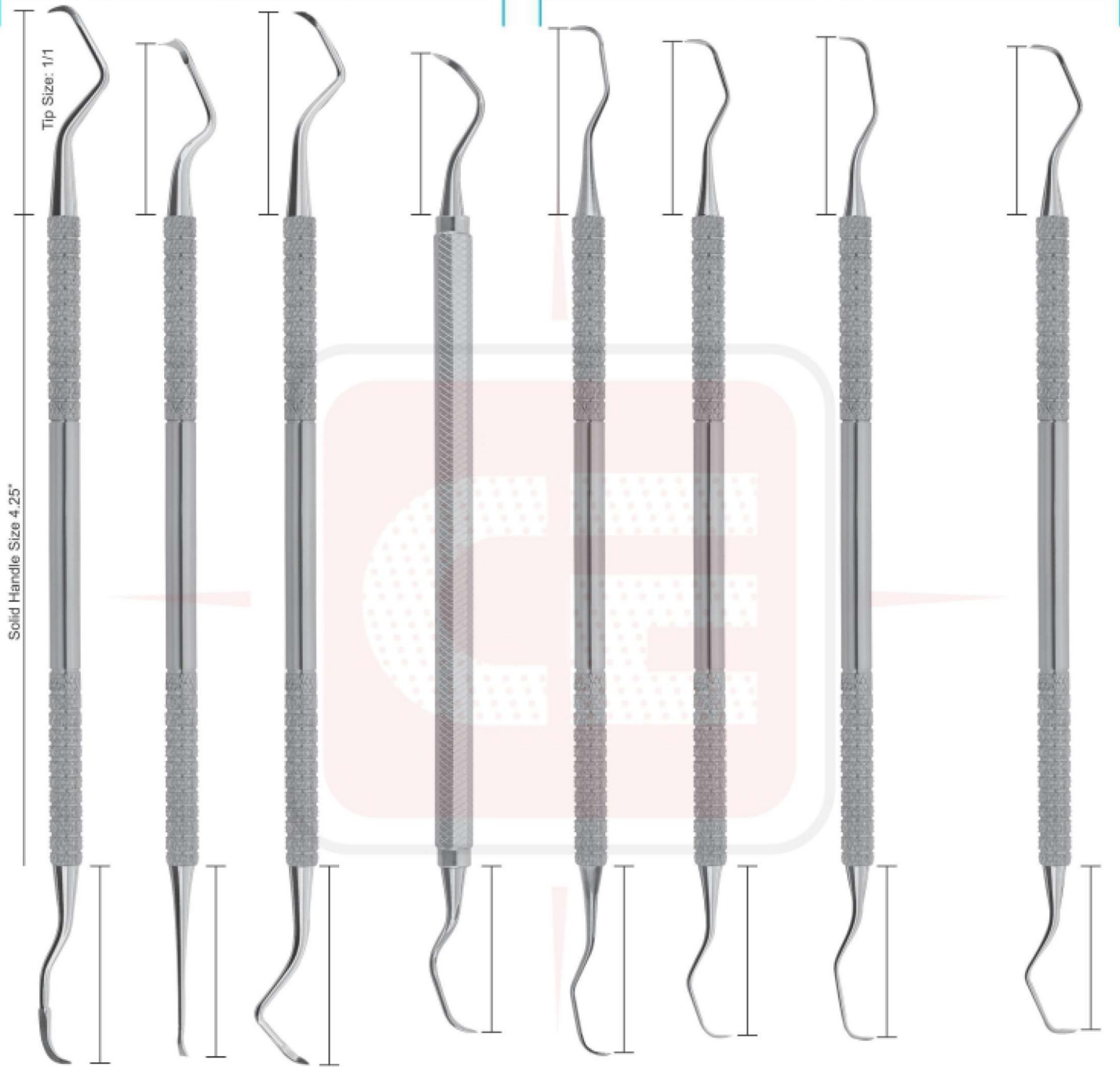

**DE-744**  
103/106  
#4, #6

**DE-744A**  
104/105  
Hoe/Chisel  
#4, #6

**DE-745**  
107/108  
#2, #4, #6  
#7, #8

**DE-746**  
107/108S  
Modied  
#2, #4

**DE-747**  
1/2  
(shown)  
#2, #4, #6  
#7, #8, #9

**DE-749**  
3/4†  
(shown)  
#2, #4, #6  
#7, #8, #9

**DE-751**  
5/6†  
(shown)  
#2, #4, #6  
#7, #8, #9

**DE-754**  
7/8†  
(shown)  
#2, #4, #6  
#7, #8, #9

**DE-748**  
1/2  
Rigid  
#2, #4, #6  
#7, #8, #9

**DE-750**  
3/4  
Rigid  
#2, #4, #6  
#7, #8, #9

**DE-752**  
5/6  
Rigid  
#2, #4, #6  
#7, #8, #9

**DE-753**  
5/6  
Extra Rigid  
#4, #6 #7,  
#8

**DE-755**  
7/8  
Rigid  
#2, #4, #6  
#7, #8, #9

**DE-756**  
7/8  
Extra Rigid  
#2, #4, #6  
#7, #8, #9

**SCALER/CURETTE SETS INSTRUMENTS  
SOLID HANDLE 6MM, LENGTH 170MM**

# CURETTES

- Кюрети
- Curetas
- Küretten
- Кюрети
- Curette
- كرتس

**GRACEY CURETTE INSTRUMENTS SOLID HANDLE 6MM, LENGTH 170MM**

**GRACEY CURETTES**

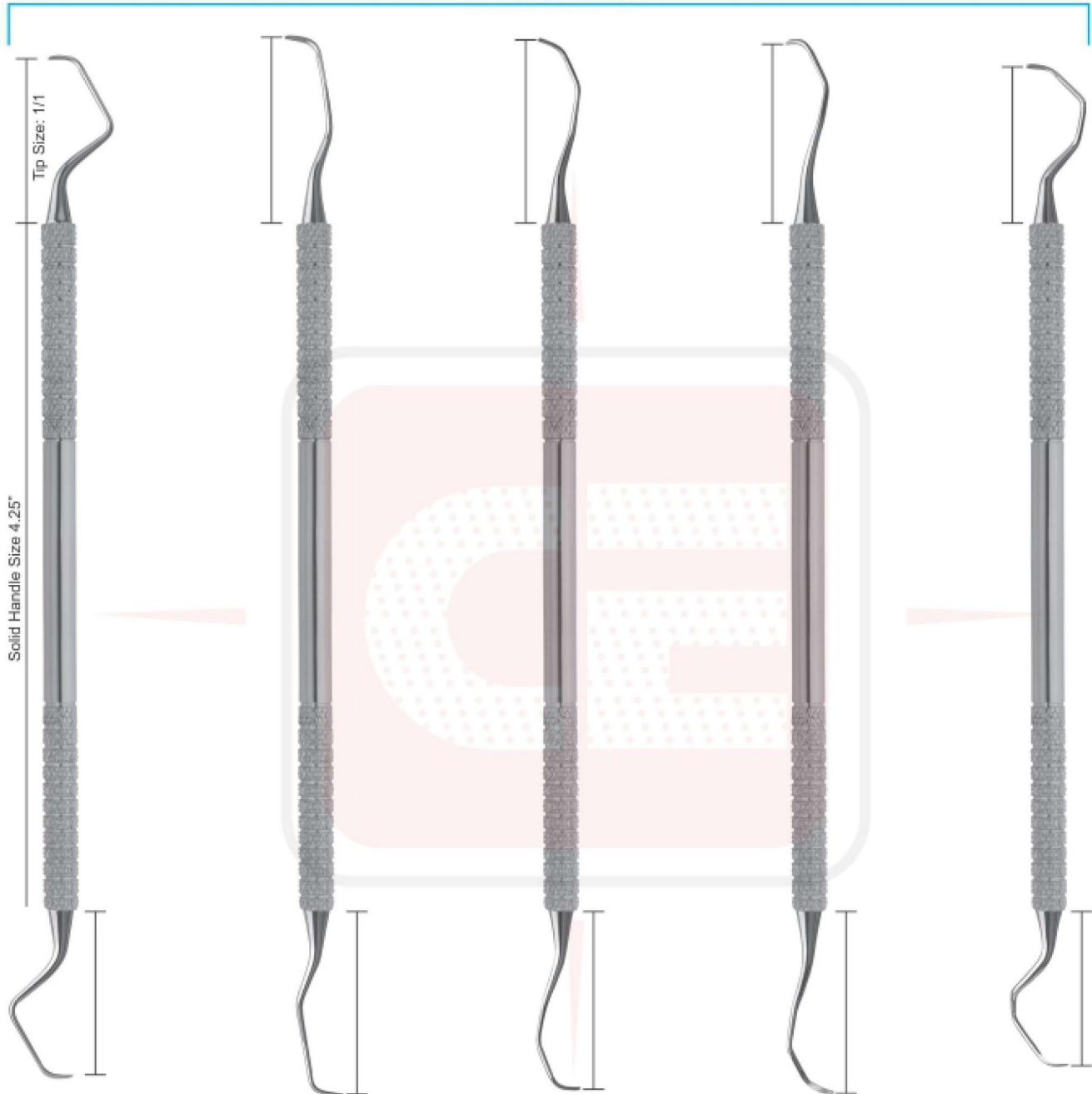

**DE-757**  
9/10+  
(shown)  
#2, #4, #6  
#7, #8, #9

**DE-759**  
11/12+  
(shown)  
#2, #4, #6  
#7, #8, #9

**DE-792**  
13/14+  
(shown)  
#2, #4, #6  
#7, #8, #9

**DE-765**  
15/16+  
(shown)  
#2, #4, #6  
#7, #8, #9

**DE-767**  
17/18  
#2, #4, #6  
#7, #8, #9

**DE-758**  
9/10  
Rigid  
#2, #4, #6  
#7, #8

**DE-760**    **DE-761**  
11/12        11/12  
Rigid        Extra Rigid  
#2, #4, #6    #4, #6 #7,  
#7, #8, #9    #8

**DE-793**    **DE-764**  
13/14        13/14  
Rigid        Extra Rigid  
#2, #4, #6 #4, #6 #7,  
#7, #8, #9    #8

**DE-766**  
15/16  
Rigid  
#2, #4, #6  
#7, #8, #9

**DE-768**  
17/18  
Rigid  
#2, #4, #6  
#7, #8, #9

# CURETTES

- Кюрети
- Curetas
- Küretten
- Кюрети
- Curette
- کرتس

**GRACEY CURETTE INSTRUMENTS SOLID HANDLE 6MM, LENGTH 170MM**

**GRACEY CURETTES**

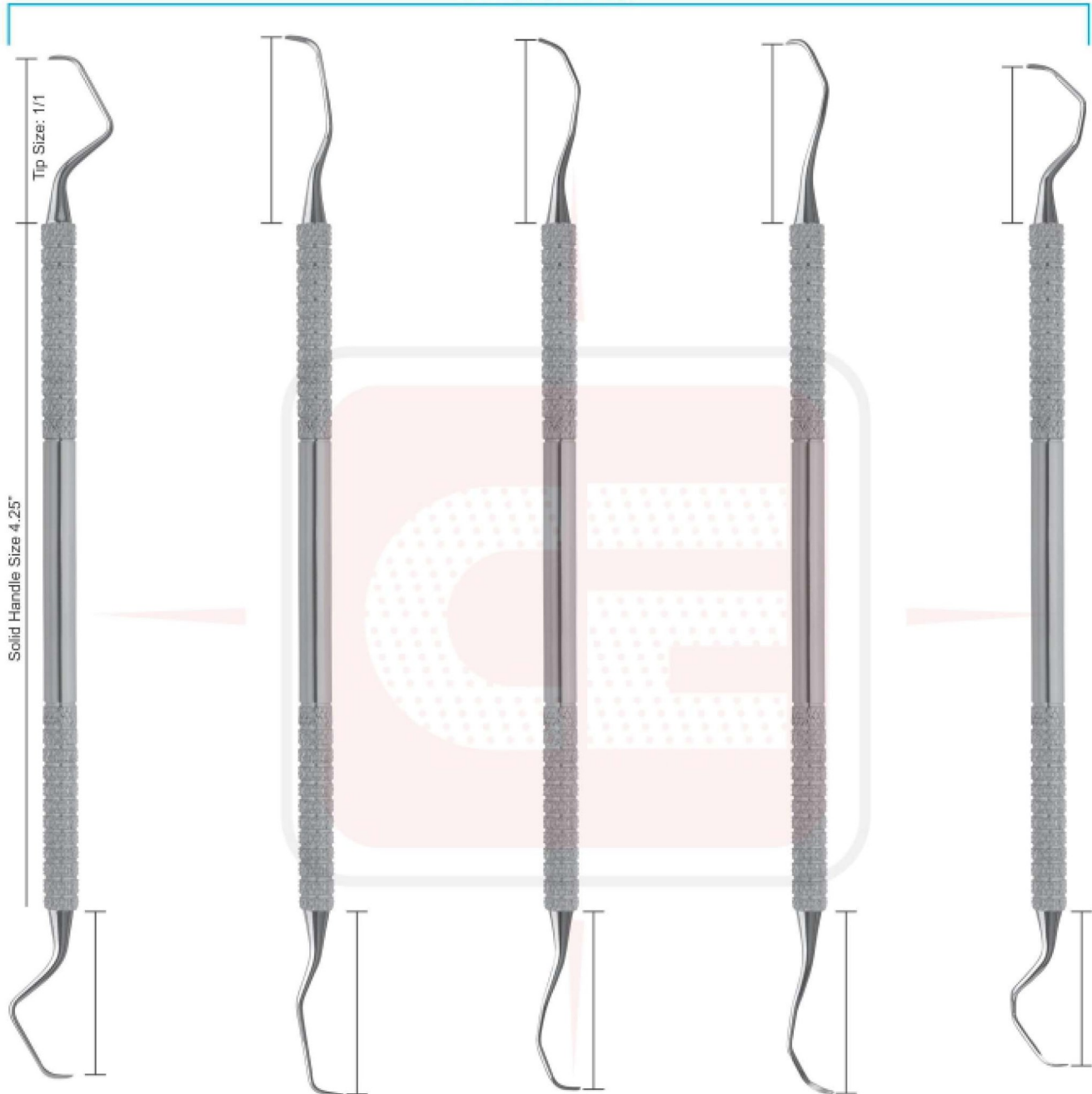

**DE-757**  
9/10+  
(shown)  
#2, #4, #6  
#7, #8, #9

**DE-759**  
11/12+  
(shown)  
#2, #4, #6  
#7, #8, #9

**DE-792**  
13/14+  
(shown)  
#2, #4, #6  
#7, #8, #9

**DE-765**  
15/16+  
(shown)  
#2, #4, #6  
#7, #8, #9

**DE-767**  
17/18  
#2, #4, #6  
#7, #8, #9

**DE-758**  
9/10  
Rigid  
#2, #4, #6  
#7, #8

**DE-760**    **DE-761**  
11/12        11/12  
Rigid        Extra Rigid  
#2, #4, #6    #4, #6 #7,  
#7, #8, #9    #8

**DE-793**    **DE-764**  
13/14        13/14  
Rigid        Extra Rigid  
#2, #4, #6 #4, #6 #7,  
#7, #8, #9    #8

**DE-766**  
15/16  
Rigid  
#2, #4, #6  
#7, #8, #9

**DE-768**  
17/18  
Rigid  
#2, #4, #6  
#7, #8, #9

# CURETTES

- Кюрети
  - Curetas
  - Küretten
- Кюрети
  - Curette
  - كرتس

**CURETTE INSTRUMENTS  
HOLLOW HANDLE 8.5MM, LENGTH 170MM**

**CURETTE INSTRUMENTS  
SOLID HANDLE 6MM, LENGTH 170MM**

**CURETTE INSTRUMENTS  
SOLID HANDLE 6MM, LENGTH 170MM**



**DE-769**  
Hemingway  
2mm, 2mm

**DE-770**  
Hemingway  
3mm, 3mm

**DE-771**  
Hemingway  
4mm, 4mm

**DE-772**  
Hemingway  
2mm, 2mm

**DE-773**  
Hemingway  
3mm, 3mm

**DE-774**  
Hemingway  
4mm, 4mm

**DE-775**  
Hemingway  
2mm, 2mm

**DE-776**  
Hemingway  
3mm, 3mm

**DE-777**  
Hemingway  
4mm, 4mm

# EXCAVATORS

- Экскаваторы
- Excavateurs
- Excavatoren
- عسكافوتوري
- Excavadores
- حفارات

**EXCAVATORS INSTRUMENTS SOLID HANDLE 6MM, LENGTH 170MM** **SPOONS**

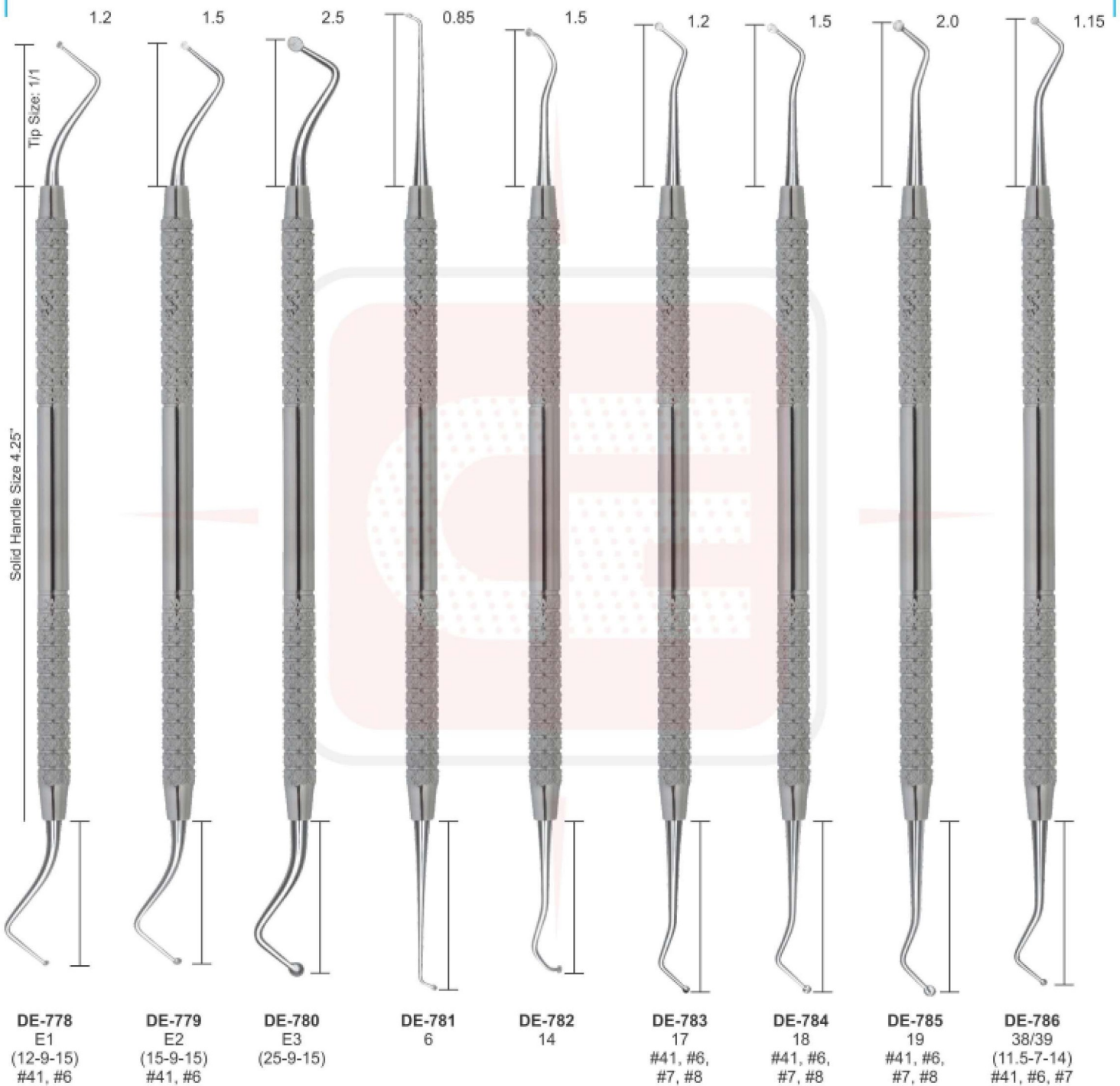

# EXCAVATORS

- Экскаваторы
  - Excavateurs
  - Excavatoren
- Бкскаватори
  - Excavadores
  - حفارات

**EXCAVATORS INSTRUMENTS**  
SOLID HANDLE 6MM, LENGTH 170MM

OVAL SPOONS/DARBY-PERRY
EXCAVATORS



Instrument Name	Tip Size	Handle Size
DE-787 17W	1.2	4.25"
DE-788 18W	1.5	4.25"
DE-789 19W	1.8	4.25"
DE-790 220/221 Darby-Perry #41, #6	1.5	4.25"
DE-791 2 Glick	1.5	4.25"
DE-792 31L #41, #6	1.0	4.25"
DE-793 31W Oval Spoon	1.3	4.25"
DE-794 32L #41, #6	1.5	4.25"
DE-795 33L #41, #6	2.0	4.25"

# EXCAVATORS

- Экскаваторы
- Excavateurs
- Excavatoren
- Excavatori
- Excavadores
- حفارات

**EXCAVATORS INSTRUMENTS  
SOLID HANDLE 6MM, LENGTH 170MM**

**BLADES**





# EXCAVATORS

- Экскаваторы
- Excavateurs
- Excavatoren

- Экскаватори
- Excavadores
- حفارات

EXCAVATORS INSTRUMENTS SOLID HANDLE 6MM, LENGTH 170MM

ENGLISH PATTERNS

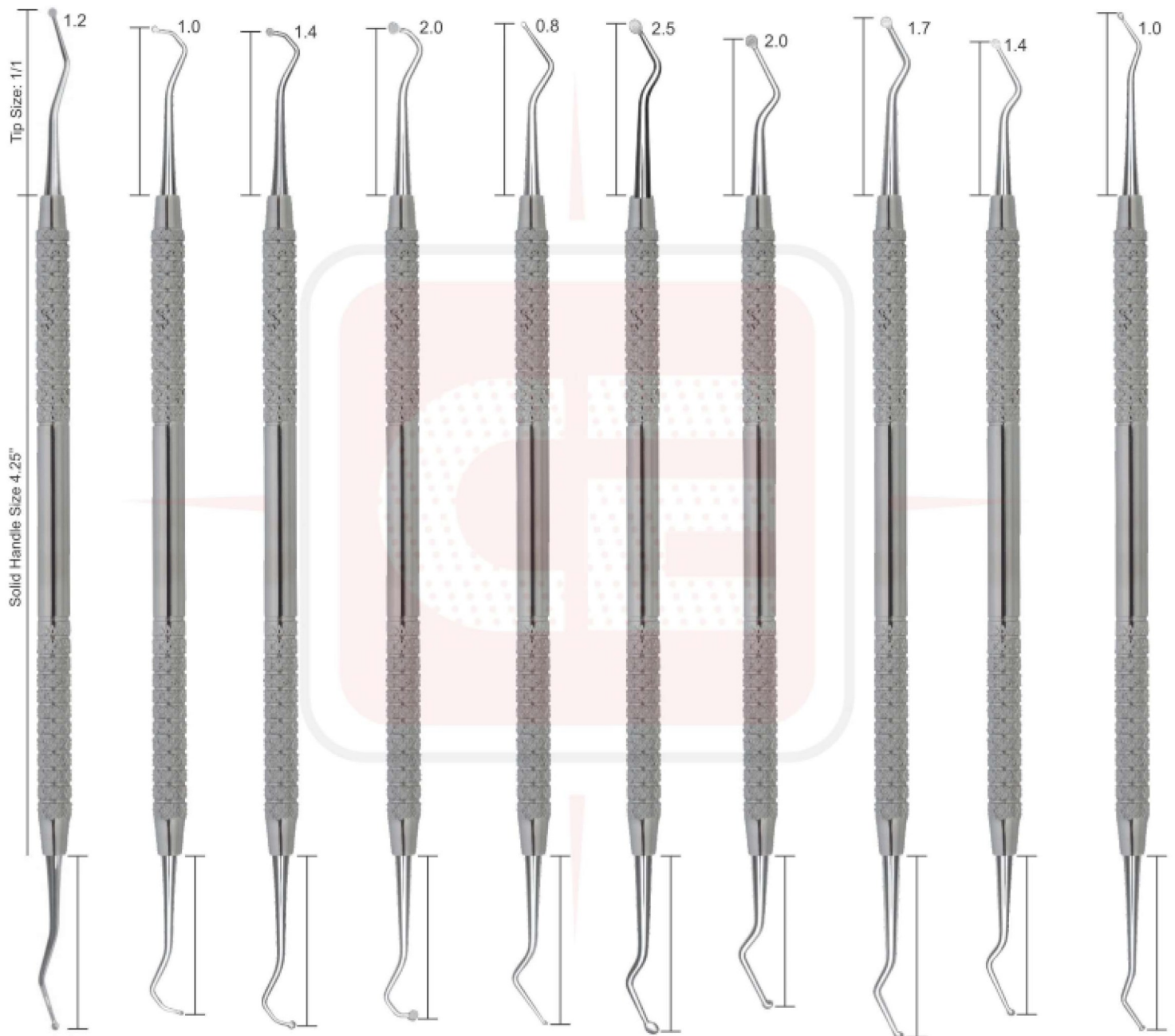

**DE-802**  
Goldstein  
Interproximal  
Excavator

**DE-803**  
243

**DE-804**  
244

**DE-805**  
245

**DE-806**  
246

**DE-807**  
125/126  
#41, #6

**DE-808**  
127/128  
#41, #6

**DE-809**  
129/130  
#41, #6

**DE-810**  
131/132  
#41, #6

**DE-811**  
153/154

# FILLING INSTRUMENTS

- Инструменты для реставрации
- Instruments pour plombage
- Füllungsinstrumente (mit Kontrawinkel)

- Инструменти для реставрації
- Instrumentos para obturaciones
- ملء الصكوك

## HATCHETS

## RESTORATIVE INSTRUMENTS SOLID HANDLE 6MM, LENGTH 170MM

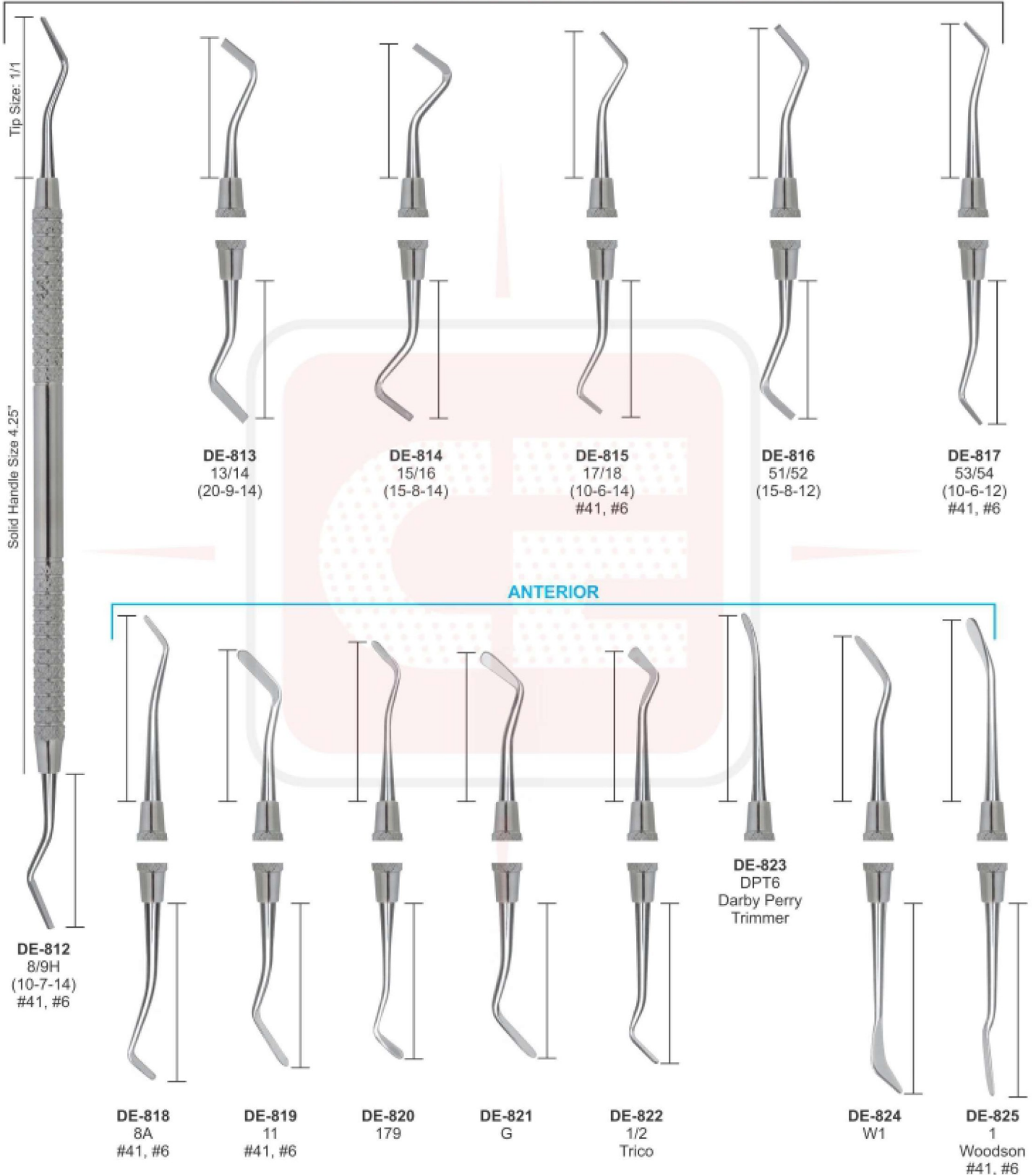

# FILLING INSTRUMENTS

- Инструменты для реставрации
- Инструменти для реставрації
- Instruments pour plombage
- Instrumentos para obturaciones
- Füllungsinstrumente (mit Kontrawinkel)
- ملء الصكوك

**CARVERS**

**RESTORATIVE INSTRUMENTS SOLID HANDLE 6MM, LENGTH 170MM**

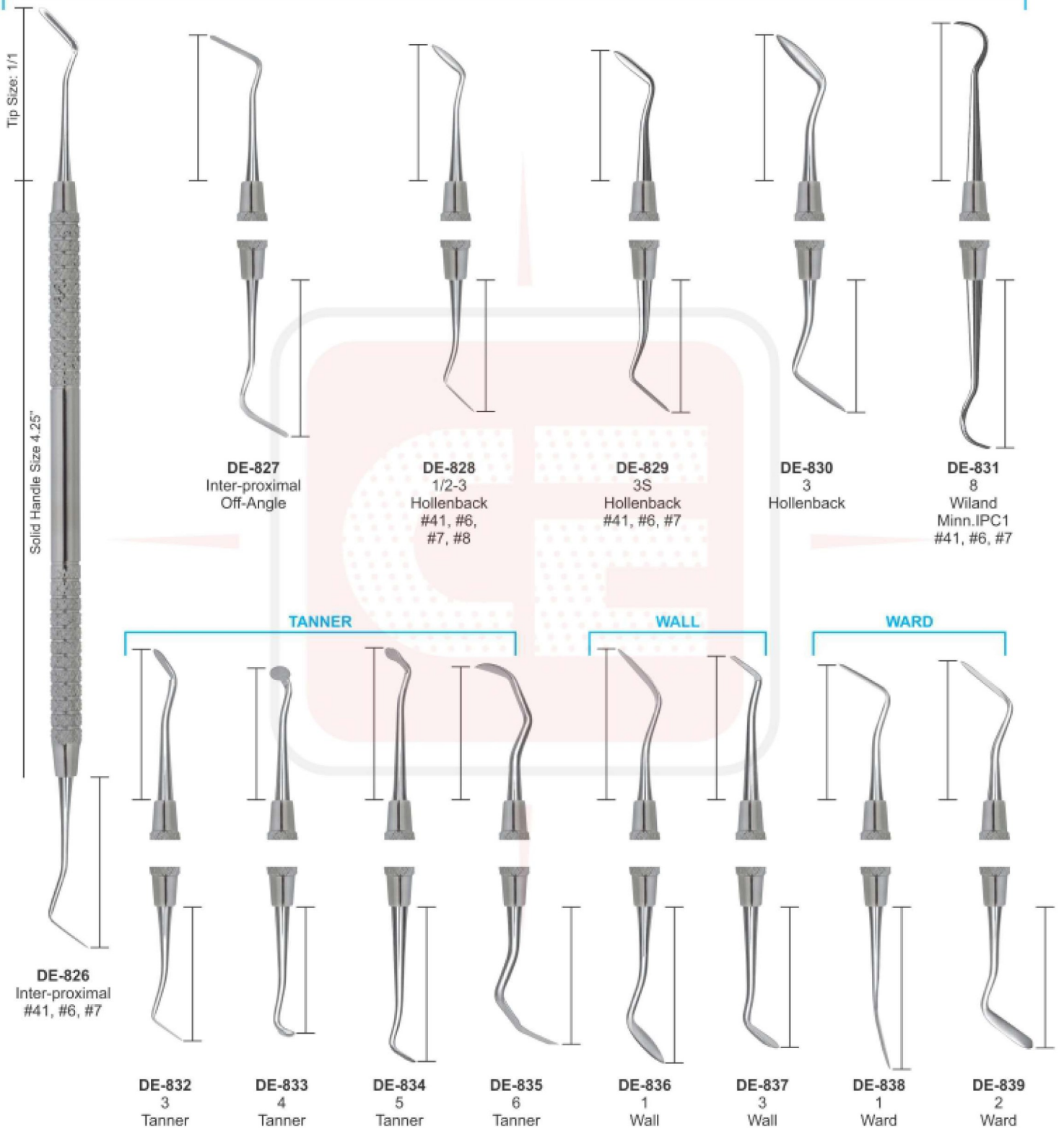

# AMALGAM CARVERS

- Инструменты для реставрации
- Instruments pour amalgame
- Amalgampistolen
- Инструменти для реставрації
- instrumentos para amalgama
- تقطیع الملعق

## RESTORATIVE INSTRUMENTS

ANDREW SOLID HANDLE 6MM, LENGTH 170MM CLAPPISON/FRAHAM

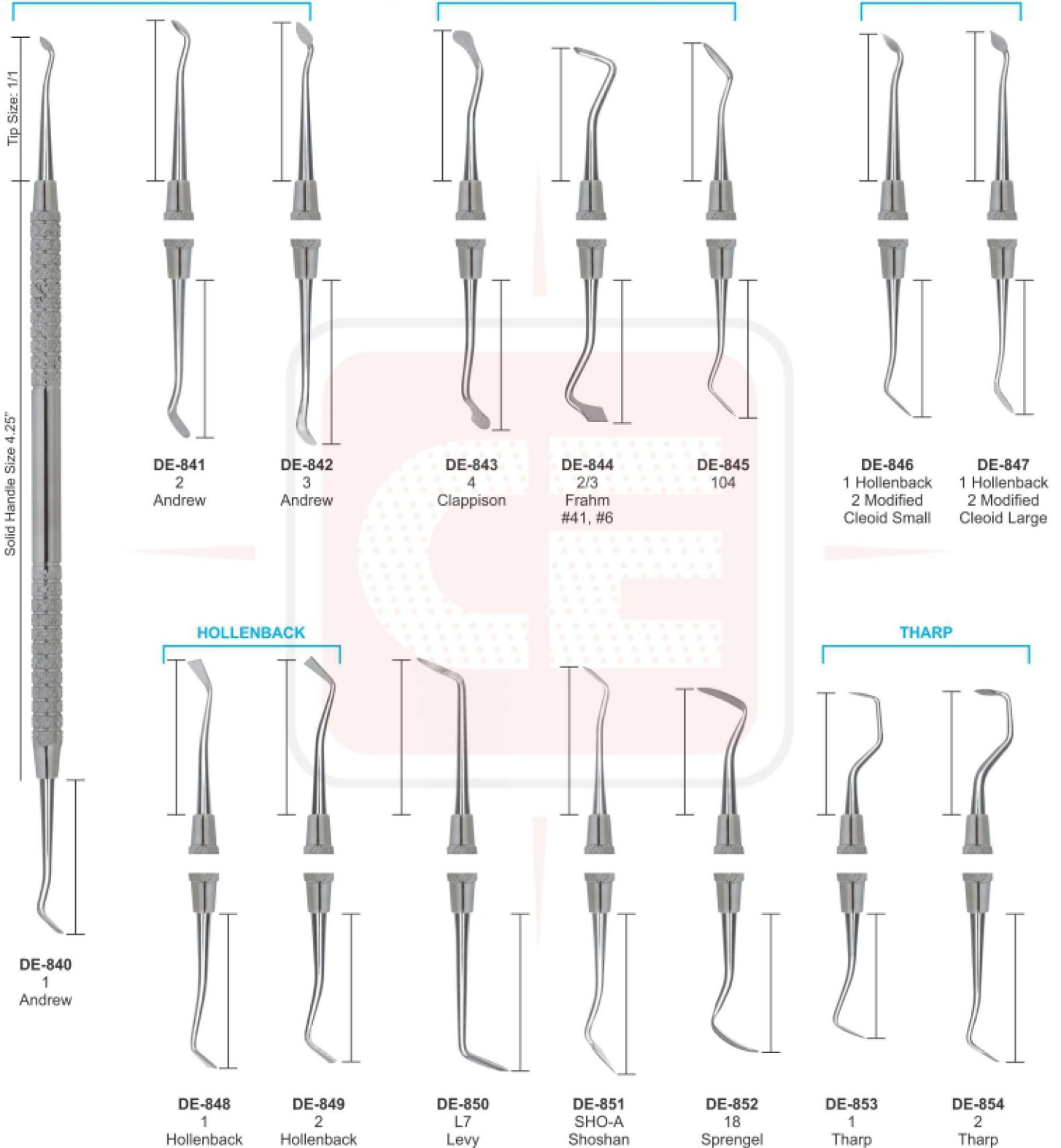

# AMALGAM CARVERS

- Инструменты для реставрации
- Instruments pour amalgame
- Amalgampistolen
- Инструменти для реставрації
- instrumentos para amalgame
- تقطيع المنغم

RESTORATIVE INSTRUMENTS SOLID HANDLE 6MM, LENGTH 170MM

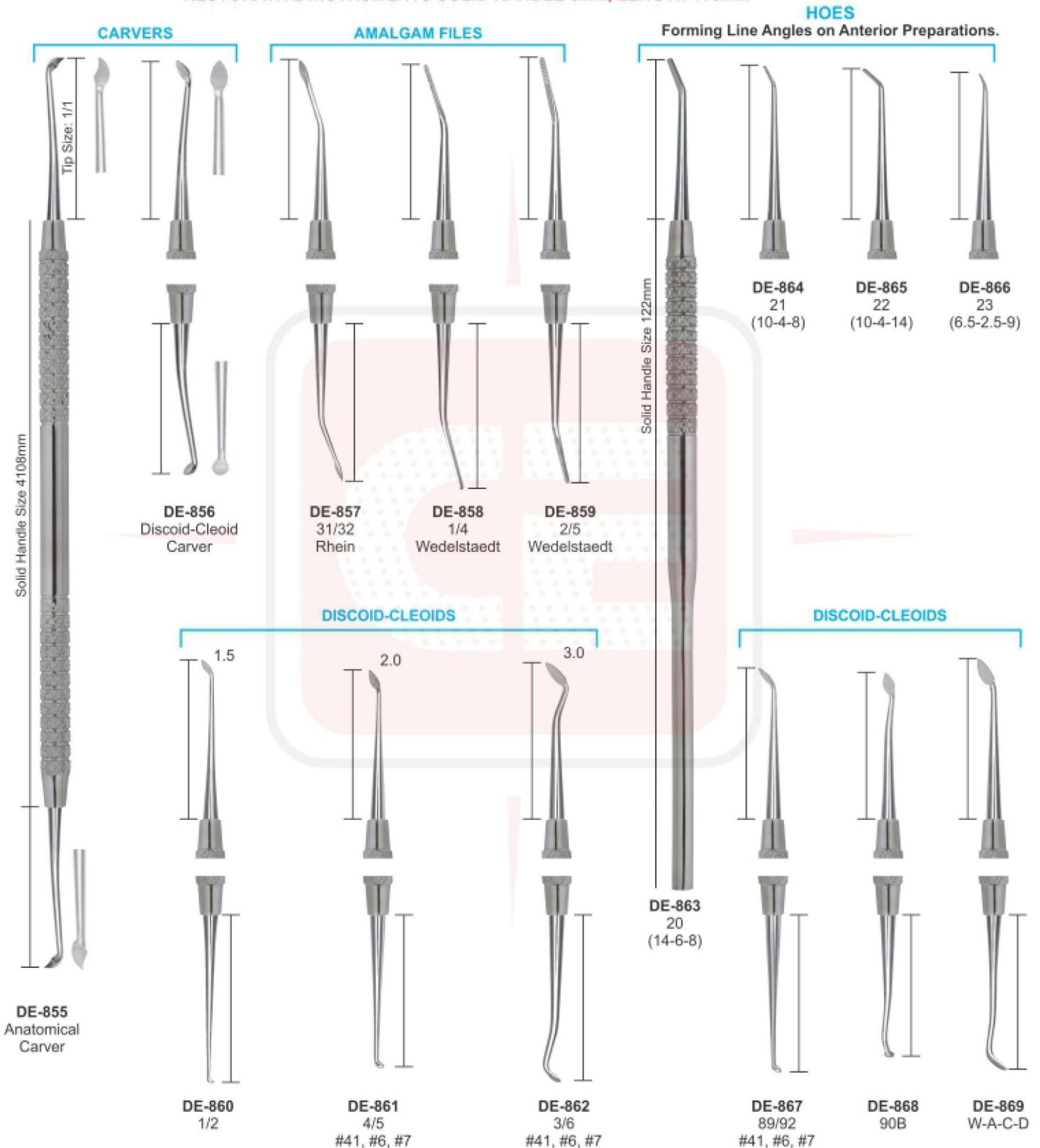

**CARVERS**

Tip Size: 1/1

Solid Handle Size 4108mm

**DE-856**  
Discoid-Cleoid Carver

**AMALGAM FILES**

**DE-857**  
31/32 Rhein

**DE-858**  
1/4 Wedelstaedt

**DE-859**  
2/5 Wedelstaedt

**HOES**  
Forming Line Angles on Anterior Preparations.

Solid Handle Size 122mm

**DE-864**  
21 (10-4-8)

**DE-865**  
22 (10-4-14)

**DE-866**  
23 (6.5-2.5-9)

**DISCOID-CLEOIDS**

1.5

2.0

3.0

**DE-855**  
Anatomical Carver

**DE-860**  
1/2

**DE-861**  
4/5  
#41, #6, #7

**DE-862**  
3/6  
#41, #6, #7

**DE-863**  
20 (14-6-8)

**DE-867**  
89/92  
#41, #6, #7

**DE-868**  
90B

**DE-869**  
W-A-C-D

# FILLING INSTRUMENTS

- Инструменты для реставрации
- Instruments pour plombage
- Füllungsinstrumente (mit Kontrawinkel)

- Инструменти для реставрації
- Instrumentos para obturaciones
- ملء الصكوك

**RESTORATIVE INSTRUMENTS**  
SOLID HANDLE 6MM, LENGTH 170MM

**MARGIN TRIMMERS**

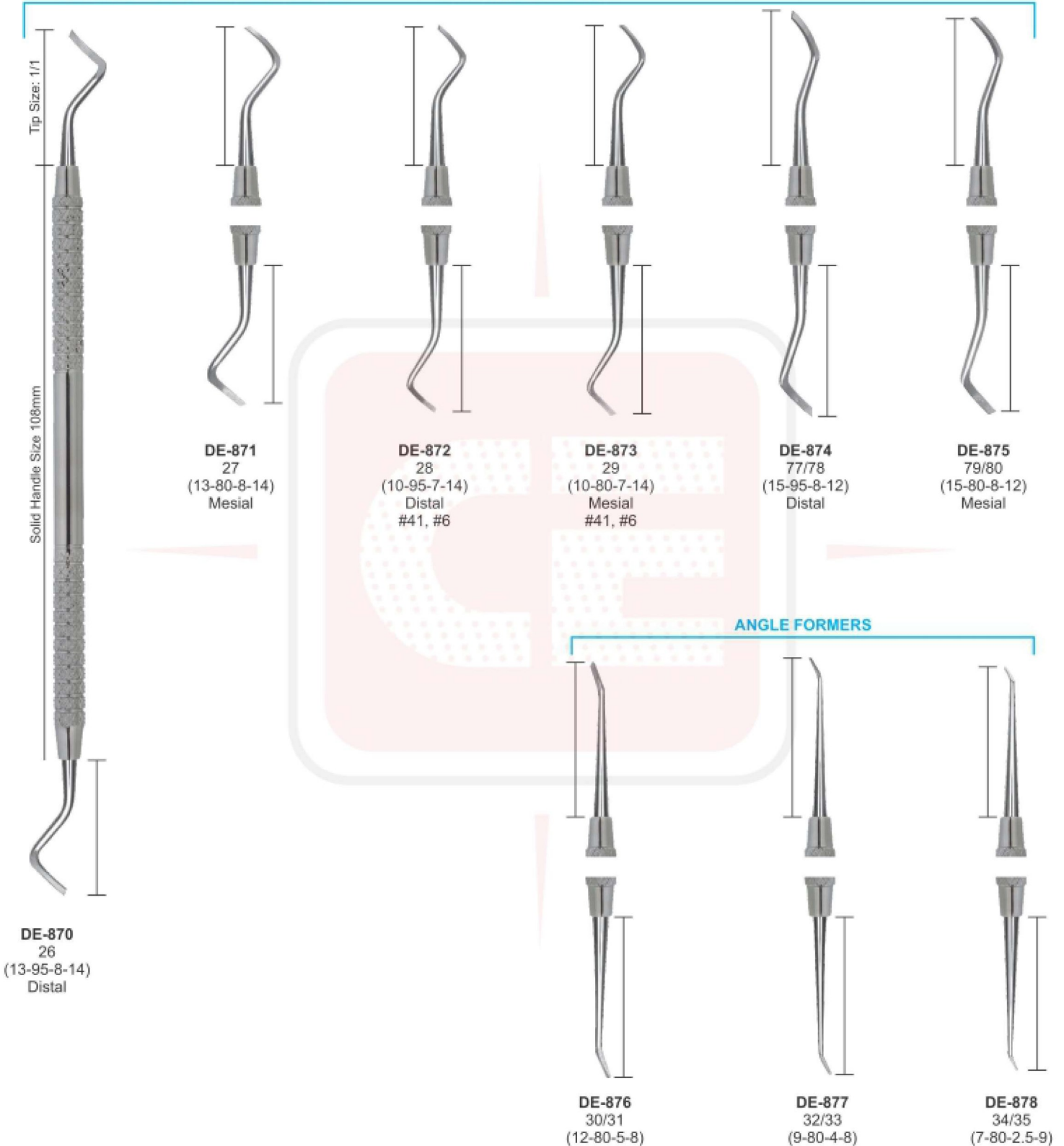

# CARVERS INSTRUMENTS

- Инструменты для реставрации
- Instruments a modeler
- Modellierinstrumente

- Інструменти для реставрації
- Instrumentos para modelar
- أدوات تقطيع

**P.K. THOMS WAXING INSTRUMENTS SOLID HANDLE 6MM, LENGTH 170MM**

**P.K. THOMAS WAXING INSTRUMENTS**

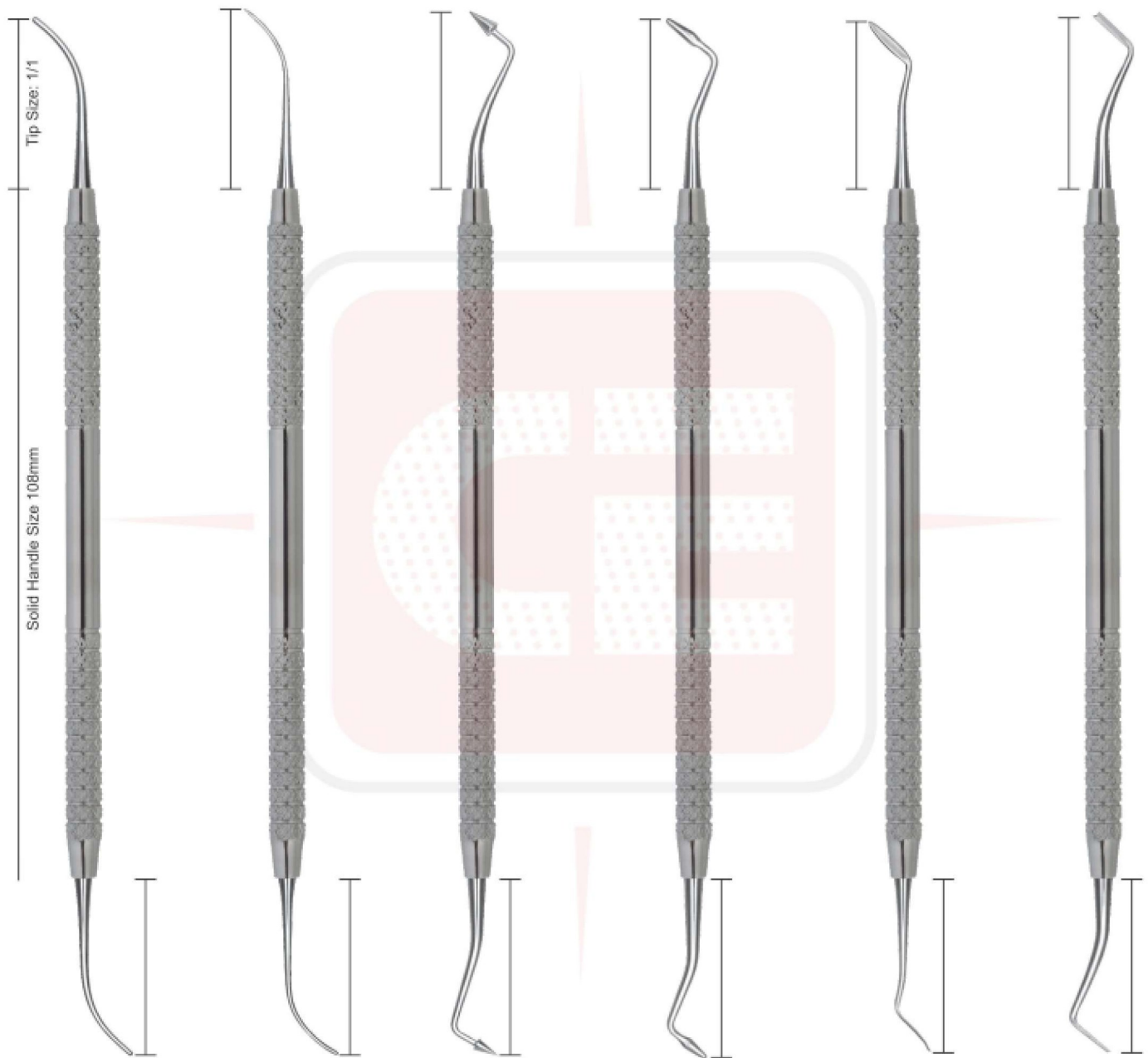

DE-879  
PKT-1

DE-880  
PKT-2

DE-881  
PKT-3  
#41, #6

DE-882  
PKT-3R  
Rounded  
Cone

DE-883  
PKT-4

DE-884  
PKT-5

# FILLING INSTRUMENTS

- Инструменты для реставрации
- Instruments pour plombage
- Füllungsinstrumente (mit Kontrawinkel)
- Инструменти для реставрації
- Instrumentos para obturaciones
- ملء الصوك

## CHISELS

## HOES

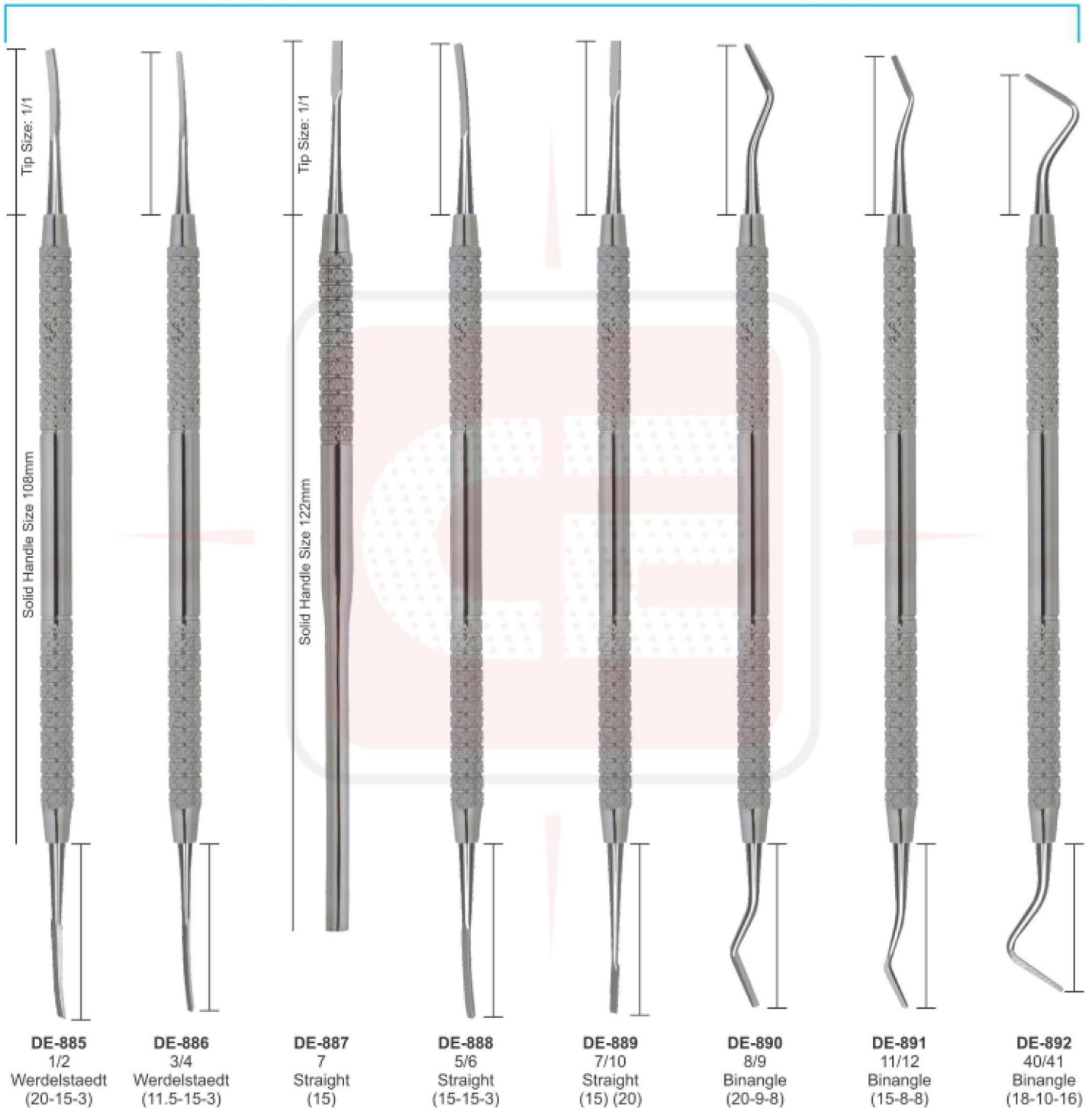



# CEMENT SPATULAS

- Шпатели для цемента
  - Spatules à ciment
  - Zementspatel
- Шпателі для цементу
  - Espátulas para cemento
  - ملاعق الأسمنت



DE-893  
00



DE-894  
0



DE-895  
1



DE-896  
2



DE-897  
3



DE-898  
4



DE-899  
3  
Weston



DE-900  
1  
medium cement



DE-901  
1



DE-902  
Le Cron



DE-903  
Le Cron



DE-904  
Le Cron



DE-905  
MSY



DE-906  
MSY



DE-907  
Le Cron



DE-908  
Hylin



DE-909  
Hylin



DE-910  
Hylin



DE-911  
Zahle



DE-912  
Zahle



DE-913  
Zahle



DE-914  
Gritman

# WAX KNIVES

- Ножи для воска
- Couteaux a cire
- Wachsmesser
- Ножі для воску
- Cuchillos para cera
- المسكاكين الشمع

ALGINATE, PLASTER SPATULAS, WAX KNIVES PLASTER FOR KNIVES & PLASTER SHEAR



**DE-915**  
Wooden Handle  
Fig. 5  
21.5 cm



**DE-916**  
Wooden Handle  
Fig. 7  
19.5 cm curved



**DE-917**  
Wooden Handle  
Fig. 8  
20 cm curved



**DE-918**  
Wooden Handle  
Fig. 9  
22.5 cm curved



**DE-919**  
Hook Knives



**DE-920**  
Fig. 1  
Lessmann  
12.5 cm



**DE-921**  
Fig. 2  
Lessmann  
17 cm



**DE-922**  
Fig. 1  
with small spoon  
12.5 cm



**DE-923**  
Fig. 2  
with large spoon  
17 cm



**DE-924**  
Bacolite Handle  
Wax Knives,  
Small



**DE-925**  
Bacolite Handle  
Wax Knives,  
Large



**DE-926**  
Wooden Handle  
Wax Knives,  
Small



**DE-927**  
Wooden Handle  
Wax Knives,  
Large



**DE-928**  
Plaster Knife



**DE-929**  
Fig. 1  
17 cm



**DE-930**  
Fig. 3  
16 cm



**DE-931**  
Fig. 4  
16 cm



**DE-932**  
Special Inox  
19.5 cm

# ARTUCLATORS

- Артикуляторы
- Artocilar
- Artikulations

- Артикулятори
- Articuler
- آرتیکولاتورس



**DE-933**

**Technical Datas:**

Intercondylar distance  
condylar inclination  
Bennet angle  
Incisal table inclination  
Distance between mounting plates  
Weight  
Opening (item 5000)  
Opening (item 5010)

120 mm.  
fixed at 30°  
fixed at 7°  
10°  
85 mm.  
400 gr.  
125°  
180°



**DE-934**

**Technical Datas:**

Intercondylar distance  
condylar inclination  
Bennet angle  
Incisal table inclination  
Distance between mounting plates  
Weight  
Opening

110 mm.  
fixed at 30°  
fixed at 7°  
flat  
85 mm.  
450 gr.  
180°



**DE-935**

Stainless Steel Finishing  
**DE-936**  
Royal Blue



**DE-937**



**DE-938**



**DE-939**



**DE-940**



**DE-941**



**DE-942**



**DE-943**



**DE-944**



**DE-945**



**DE-946**  
Nakawalni  
Dental Laboratory  
Instrument

## MAXILLOFACIAL SURGERY INSTRUMENTS

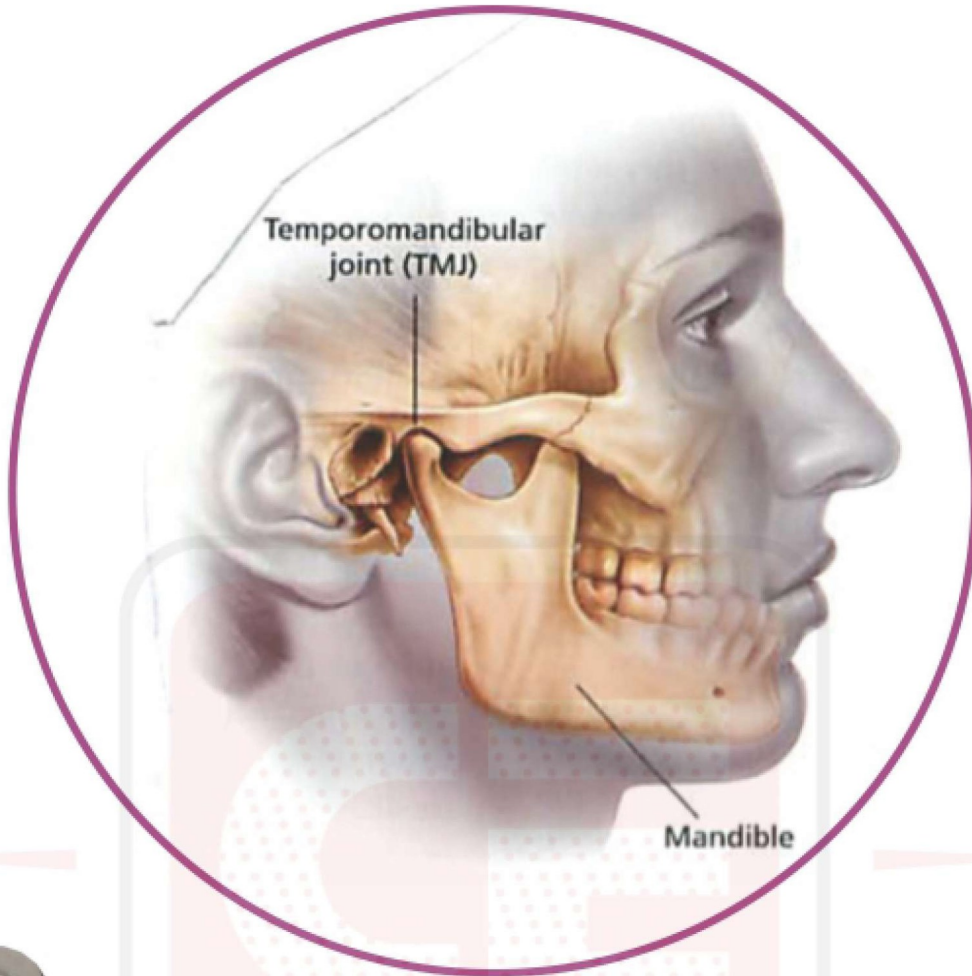

## RETRACTORS & MOUTH GAGS

- Роторасширители
- Роторозширювачі
- Ecarteurs - Ouvre-bouches
- Separadores - Abre-bocas
- Vestibulumabhalter / Mundspanner
- الكاشطات - الكمامات الفم



**DE-947**  
Mouth Gag Molt  
11 cm for (Children)



**DE-948**  
Mouth Gag Molt  
14 cm for (Adults)



**Cheek Retractor**  
**DE-949** 140 mm  
**DE-950** 180 mm



**Cheek Retractor**  
**DE-951** 140 mm



**DE-952**  
Wangen Holder,  
vestibule  
15 cm, with or without  
lip protection,



**DE-953**  
Wangen Holder,  
vestibule 15 cm, with  
or without lip protection,



**DE-954**  
Wangen Holder  
Wangen holder with dual  
function, 17 cm,



**DE-955**  
140 mm

**DE-956**  
150 mm

**Cheek Retractor**

## RETRACTORS & MOUTH GAGS

- Роторасширители
- Ecarteurs - Ouvre-bouches
- Vestibulumabhalter / Mundspanner
- Роторозширювачі
- Separadores - Abre-bocas
- الكاشطات، الكشطات القم



**DE-957**  
Fig. 1  
weitlaner  
10.5cm  
13.5cm



**DE-958**  
Fig. 2  
weitlaner  
10.5cm  
13.5cm



**DE-959**  
Stainless Steel  
Double  
Ended Cheek  
Retractors



**DE-960**  
Stainless Steel  
Single  
Ended Cheek  
Retractors



**DE-961** Weitlander 11cm  
**DE-962** 13cm  
**DE-963** 15cm



**DE-967**  
Denhard  
12 cm



**DE-968**  
Roser-König  
16 cm



**DE-969**  
Roser-König  
19 cm



**DE-964** Jennings 11cm  
**DE-965** 13cm  
**DE-966** 15cm

# RETRACTORS

**Wound, Bendable**  
Retractor, individually or as saving kit!

- Ранорасширители
- Ecarteurs
- Wundhaken

- Ранорозширювачі
- Separadores
- الكاشحات



**DE-970**  
Cheek Retractor  
Long



**DE-971**  
Cheek Retractor  
Long



**DE-972**  
Cheek Retractor  
Long



**Retractor with  
Ergo Grip  
DE-973** 24 cm,  
ergonomic handle,



**DE-974**  
Cheek Retractors,  
Retractor Ivory  
Width adjustable  
& fixable, 20 cm,



**Cheek Retractors,  
tongue depressors  
DE-975** 19 cm



**Cheek Retractors,  
Minnesota  
DE-976** 16 cm



**Cheek Retractors,  
DE-977** 20 cm  
easy to bend  
by hand,



**Cheek Retractors,  
retractor and tongue  
pushers BISHOP with  
comfortable margin,  
DE-978** 16 cm,



**Retractors Cheek  
retractor combination  
Combination,  
DE-979** 25 cm,

# RETRACTORS

- Ранорасширители
  - Ecarteurs
  - Wundhaken
- Ранорозширювачі
  - Separadores
  - الكاشطات



**DE-980**  
Retractors, Unique  
Length 175 mm,  
angled 45°



**DE-981**  
Retractors, Unique  
Length 175 mm,  
angled 90°



**DE-982**  
Retractors, Unique  
Length 175 mm,  
angled 45°



**DE-983**  
Retractors, Unique  
Length 175 mm,  
angled 90°



**DE-984**  
Retractors  
16cm



**DE-985**  
Retractors  
19cm



**DE-986**  
Retractors, Mini-Langenbeck  
16 cm, hooks 22 mm,



**DE-987**  
Retractors, Cheek  
retractors combination  
21 cm, 2



**DE-988**  
Mini Retractor  
about 8 cm,



**DE-989**  
Retractors  
17 cm, hooks 22 mm



# RETRACTORS

- Ранорасширители
- Ранорозширювачі
- Ecarteurs
- Separadores
- Wundhaken
- الكاشطات



**DE-990**  
Retractors, surgical-flat  
surgically-flat, 21 cm, hook  
30x16 mm,



**DE-991**  
Retractors, surgical-flat  
surgically-flat, 21 cm, hook  
42x11 mm



**DE-992**  
Retractors, surgical-flat  
surgically-flat, 21 cm, hook  
63x12 mm,



Retractors, surgical-flat  
surgically-flat, 21 cm, hook  
**DE-993** 30x16 mm,  
**DE-994** 42x11 mm  
**DE-995** 63x12 mm,



Retractors, Langenbeck  
21 cm, hook  
**DE-996** 30x11 mm  
**DE-997** 30x16 mm,



**DE-998**  
Retractors  
21 cm,



**DE-999**  
Farabeuf  
(120 X 12mm  
Set of 2 pices)



**DE-1000**  
Retractor Seldin



**DE-1001**  
FELDMAN  
RETRACTOR  
5-1/2", 14cm

## GUM SCISSORS

- Ножницы десневые
- Ciseaux a gengivas
- Zahnfleischscheren
- Ножиці для ясен
- Tijeras para encias
- مقص صمغ



**DE-1002**  
Iris  
115mm  
Straight



**DE-1003**  
Iris  
115mm  
Curved



**DE-1004**  
Goldman-Fox  
130mm  
Saw edge, straight



**DE-1005**  
Goldman-Fox  
130mm  
Saw edge, Curved



**DE-1006**  
La Grange  
115mm  
Saw edge, double Curved



Mayo  
**DE-1007** 140mm  
**DE-1008** 170mm  
**DE-1009** 230mm  
Straight



Mayo  
**DE-1010** 140mm  
**DE-1011** 170mm  
**DE-1012** 230mm  
Curved



Metzenbaum  
**DE-1013** 145mm  
**DE-1014** 180mm  
**DE-1015** 200mm  
Straight



Metzenbaum  
**DE-1016** 145mm  
**DE-1017** 180mm  
**DE-1018** 200mm  
Curved



**DE-1019**  
Kelly  
160mm  
Straight



**DE-1020**  
Kelly  
160mm  
Curved



**DE-1021**  
Iris  
115mm  
Straight



**DE-1022**  
Iris  
115mm  
Curved



**DE-1023**  
La Grange  
115mm  
Double Curved



**DE-1024**  
Goldman-Fox  
130mm, Straight



**DE-1025**  
Goldman-Fox  
130mm, Curved



**DE-1026**  
Kelly  
160mm, Curved



**DE-1027**  
Iris  
115mm, Straight



**DE-1028**  
Iris  
115mm, Curved



**DE-1029**  
Micro Iris  
90mm, Curved

## GUM SCISSORS

- Ножницы десневые
- Ciseaux a gencives
- Zahnfleischscheren

- Ножиці для ясен
- Tijeras para encias
- مقصص صمغ



# SCISSORS & NEEDLE HOLDERS

- Иглодержатели
  - Porte-aiguilles
  - Nadelhalter
- Голкотримачи
  - Porta-agujas
  - أصحاب إبرة



**DE-1053**  
130mm  
Straight



**DE-1054** Mayo 130mm  
**DE-1055** Mayo 160mm  
**DE-1056** Mayo 180mm  
Straight Curved

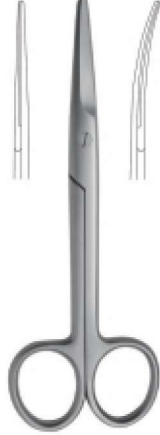

**DE-1057** Mayo 140mm  
**DE-1058** Mayo 200mm  
Straight Curved



**DE-1059** Metzenbaum 145mm  
**DE-1060** Metzenbaum 200mm  
Straight Curved



**DE-1061**  
Beebee  
110mm  
Saw edge,  
straight



**DE-1062**  
Beebee  
110mm  
Saw edge,  
curved



**DE-1063**  
Beebee  
110mm  
Saw edge, straight



**DE-1064**  
Beebee  
110mm  
Saw edge, curved

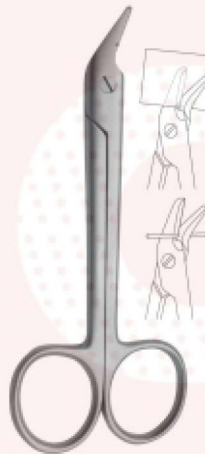

**DE-1065**  
Universal  
120mm  
Saw edge



**DE-1066**  
Universal  
120mm



Crile  
**DE-1067** 130mm  
**DE-1068** 150mm  
**DE-1069** 180mm



**DE-1070**  
Halsey  
130mm



**DE-1071**  
Baumgartner  
130mm



**DE-1072**  
Derf  
120mm



**DE-1073**  
Delicate  
150mm



Mayo-Hegar  
**DE-1074** 130mm  
**DE-1075** 160mm  
**DE-1076** 180mm  
**DE-1077** 200mm



**DE-1078**  
Crile-Wood  
150mm  
straight



**DE-1079**  
Crile-Wood  
150mm  
curved

# NEEDLE HOLDERS

- Иглодержатели
- Porte-aiguilles
- Nadelhalter

- Голкотримачи
- Porta-agujas
- اصحاب ابرة



Castroviejo  
**DE-1080** 130mm  
**DE-1081** 150mm  
**DE-1082** 180mm



**DE-1083**  
 Halsey  
 130mm



**DE-1084**  
 Baumgartner  
 130mm



**DE-1085**  
 Derf  
 120mm



**DE-1086**  
 Delicate  
 150mm



**DE-1087**  
 Adson  
 170mm



Mayo-Hegar  
**DE-1088** 130mm  
**DE-1089** 160mm  
**DE-1090** 180mm  
**DE-1091** 200mm



**DE-1092**  
 Crile-Wood  
 150mm



Castroviejo  
**DE-1093** str 140mm cvd  
**DE-1094** str 180mm cvd



Olsen-Hegar Needle  
 Holder With Scissors  
**DE-1095** 140mm



Gillies Needle  
 Holder With Scissors  
**DE-1096** 160mm



Mathieu  
**DE-1097** 140mm  
**DE-1098** 170mm



Castroviejo  
**DE-1099** str 140mm cvd  
**DE-1100** str 180mm cvd



Olsen-Hegar Needle  
 Holder With Scissors  
**DE-1101** 140mm



Gillies Needle  
 Holder With Scissors  
**DE-1102** 160mm

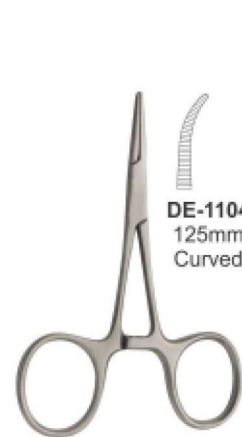

Hartmann (Baby  
 Mosquito)  
**DE-1103** 90mm straight



Halstead Mosquito  
**DE-1105** 125mm  
 Straight

**DE-1106**  
 Curved

**DE-1104**  
 125mm  
 Curved

# HAEMOSTATIC FORCEPS & TOWEL CLAMPS

- Зажимы артериальные, зажимы для салфеток
- Pinças hemostáticas, Pincas a compresses
- Arterienklemmen, Tuschklemmen
- Затискачі артеріальні, затискачі для серветок
- Pinzas hemostáticas, Pincas para compressas
- الملقط هایموستاتیک المشابک منشفة

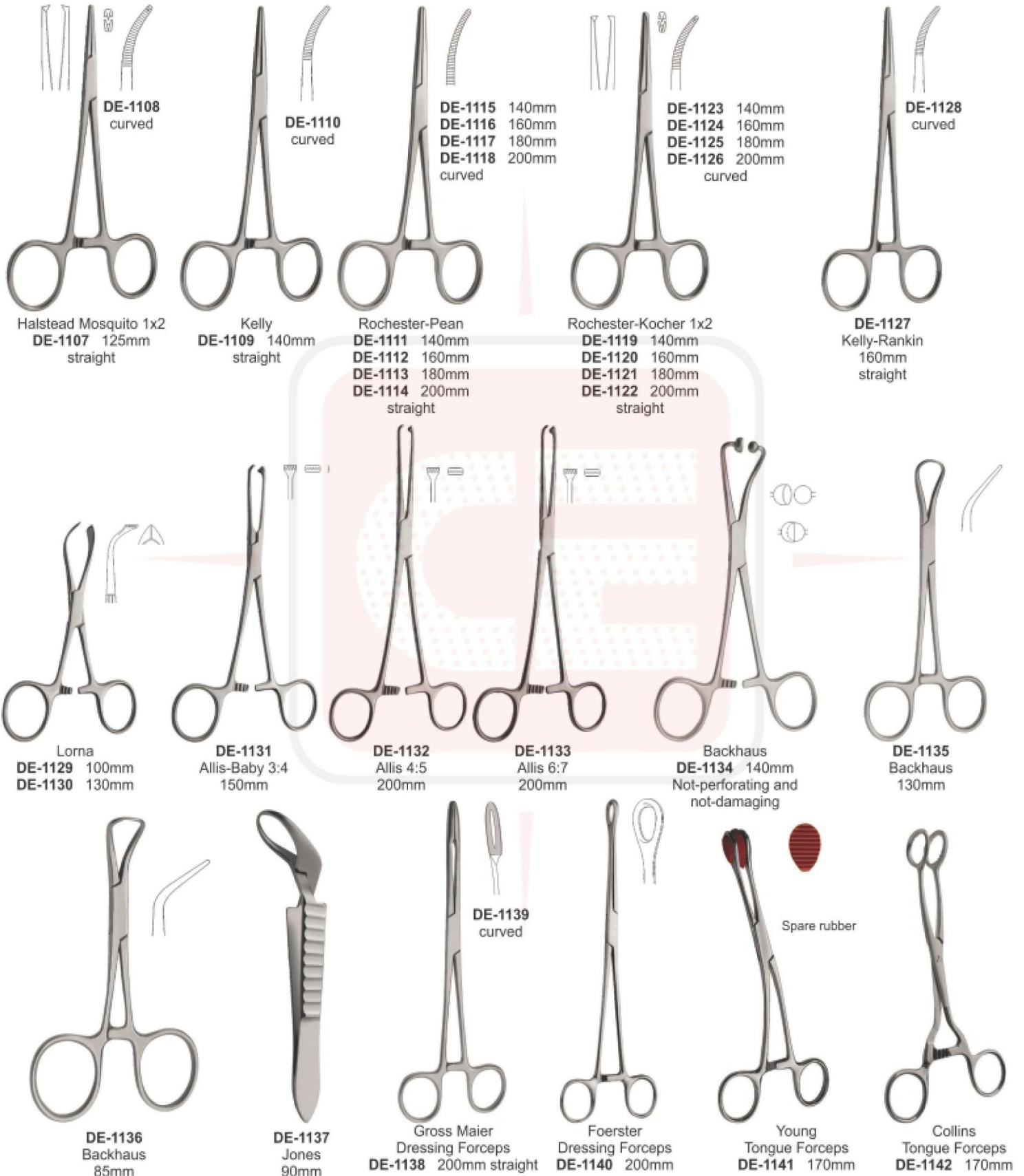

## RUBBER DAM CLAMPS FORCEPS

- Инструменты для системы коффердам
- Pincas porte-crampons a digue
- Kofferdam Klammerzangen
- Инструменти для системи коффердам
- Pinzas de engrapar para dique de caucho
- المد المطاط المنقط المشابك



### DE-1143

On request the Content of the rubber dam kit can be changed with other instruments.

#### Content:

- |    |                           |    |                           |
|----|---------------------------|----|---------------------------|
| 01 | Anisworth                 | 08 | Rubber Dam Clamp Fig. 212 |
| 02 | Brewer                    | 09 | Rubber Dam Clamp Fig. 211 |
| 03 | Clamps Stand              | 10 | Rubber Dam Clamp Fig. 8   |
| 04 | Denture Plate             | 11 | Rubber Dam Clamp Fig. 8A  |
| 05 | Rubber Dam Frame          | 12 | Rubber Dam Clamp Fig. 14  |
| 06 | Rubber Dam Box Lower Case | 13 | Rubber Dam Clamp Fig. 14A |
| 07 | Rubber Dam Box Upper Case | 14 | Rubber Dam Clamp Fig. 0   |
|    |                           | 15 | Rubber Dam Clamp Fig. 00  |
|    |                           | 16 | Rubber Dam Clamp Fig. 2   |
|    |                           | 17 | Rubber Dam Clamp Fig. 2A  |
|    |                           | 18 | Rubber Dam Clamp Fig. 7   |



**DE-1144**  
Anisworth



**DE-1145**  
Brewer



**DE-1146**  
Ivory light weight



**DE-1147**  
Palmer



**DE-1148**  
Seaparating  
Elastic  
Plier

# RUBBER DAM CLAMPS

- Кляммера для коффердама
- Стампы для дамбы
- Kofferdam Klammern
- Кляммера для коффердама
- Grapas para dique de caucho
- المشابك المد المطاط



DE-1149  
Fig. 15



DE-1150  
Fig. 18



DE-1151  
Fig. 24



DE-1152  
Fig. 25



DE-1153  
Fig. 26



DE-1154  
Fig. 28



DE-1155  
Fig. 30



DE-1156  
Fig. 31



DE-1157  
Fig. 51



DE-1158  
Fig. 138



DE-1159  
Fig. 139



DE-1160  
Fig. 200



DE-1161  
Fig. 201



DE-1162  
Fig. 202



DE-1163  
Fig. 203



DE-1164  
Fig. 204



DE-1165  
Fig. 205



DE-1166  
Fig. 3



DE-1167  
Fig. W3



DE-1168  
Fig. 4



DE-1169  
Fig. 56A



DE-1170  
Fig. 7



DE-1171  
Fig. 7A



DE-1172  
Fig. 8



DE-1173  
Fig. 8A



DE-1174  
Fig. W8A



DE-1175  
Fig. 10



DE-1176  
Fig. 11



DE-1177  
Fig. 12A



DE-1178  
Fig. 13A



DE-1179  
Fig. 14



DE-1180  
Fig. 14A



DE-1181  
Fig. 14AN



DE-1182  
Fig. 22



DE-1183  
Fig. 27



DE-1184  
Fig. 207



DE-1185  
Fig. 29



DE-1186  
Fig. 206



DE-1187  
Fig. 208



DE-1188  
Fig. 209



DE-1189  
Fig. 1



DE-1190  
Fig. 1A



DE-1191  
Fig. 2



DE-1192  
Fig. 2A



DE-1193  
Fig. W2A



DE-1194  
Fig. 0



DE-1195  
Fig. 00



DE-1196  
Fig. 210



DE-1197  
Fig. 211



DE-1198  
Fig. 212



DE-1199  
Fig. 6



DE-1200  
Fig. 9



DE-1201  
Fig. N06



DE-1202  
Fig. U67



DE-1203  
Fig. 214



DE-1204  
Fig. P1



DE-1205  
Fig. P2



DE-1206  
Fig. G-1



DE-1207  
Fig. G-2



# CROWN REMOVER

- Инструменты для удаления коронок
- Arrache-couronnes
- Teleskopkronenzangen
- Инструменти для видалення коронок
- Arranca-corona
- مزيلات التاج



**DE-1208**  
Power Crown Remover Lift



**DE-1209**  
Power Crown Remover Right



**DE-1210**  
Crown Spreaders



**DE-1211**  
Mershon  
14 cm  
Band Pusher



**DE-1212**  
Fig. 0



**DE-1213**  
Manual Crown Remover



**DE-1214**  
Complete with 3 tips  
and tightening keys

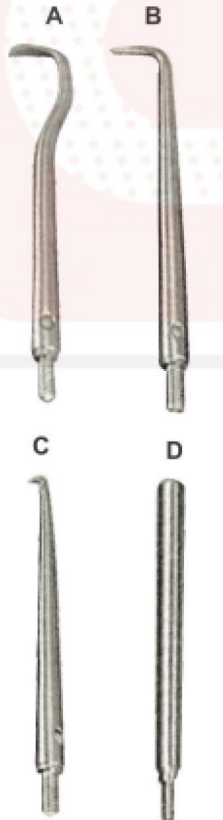

semi-automatic crown  
& bridge remover



**DE-1215**



**DE-1216**  
Manual Crown Remover

# MATRIX RETAINERS

- Матрицедержатели
- Porte Matrices
- Matrizenspanner

- Матрицеутримувачи
- Porta Matrices
- مصفوفة الخدم



**DE-1217**  
Fig. 5  
Ivory 8  
5 cm



**DE-1218**  
Fig. 6  
Ivory 8  
6 cm



**DE-1219**  
Fig. 7  
Ivory 8  
7 cm



**DE-1220**  
Fig. 1  
Tofflemire-Universal



**DE-1221**  
Fig. 2  
Tofflemire-Junior



**DE-1222**  
Fig. 3  
Tofflemire-Senior



**DE-1223**  
Narrow



**DE-1224**  
Wide

## Siqveland Retainers

## Amalgam Well



**DE-1225**  
Stainless Steel  
Amalgam Well



**DE-1226**  
Ivory 12



**DE-1227**  
Ivory 1



**DE-1228**  
Ivory



**DE-1229**  
Elliot

## AMALGAN INSTRUMENTS & SCALPEL HANDLES

• Amalgamis/instrumente

• Инструменти для амальгами  
• Instrumentos para amalgama  
• الصكوك الملمع

• Ручки для скальпелей  
• Manches de bistouris  
• Skalpellgriffe

• Ручки для скальпелів  
• Mangos de bisturi  
• مشرط مقابض



**DE-1230**  
Fig. 10  
165mm  
English pattern



**DE-1231**  
Fig. 1  
185mm  
German pattern



**DE-1232**  
Fig. 1  
150mm  
Swiss pattern



**DE-1233**  
Fig. 1  
150mm



**DE-1234**  
Fig. 2  
150mm, 45°



**DE-1235**  
Fig. 3  
140mm, 90°



**DE-1236**  
Fig.3  
5" (12.7cm)



**DE-1237**  
Fig.3G  
5" (12.7cm)



**DE-1238**  
Fig.4  
5 1/2" (13.7cm)



**DE-1239**  
6 Way Adjustable Angled  
Scalpel Handle

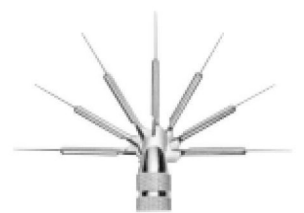

Locks At 90°, 60°, 30°,  
Straight, 120°, 150°, 180°,  
Angles

# AMALGAN INSTRUMENTS

- Инструменты для амальгамы
- Instruments pour amalgame
- Amalgamis/Instrumente
- Инструменты для амальгами
- Instrumentos para amalgama
- الصكوك المنلفم

## AMALGAM CARRIERS

### TIP SIZES FOR DOUBLE-END

1.5 mm      2.8 mm      3.2 mm



2.0 mm

**DE-1243**  
Mini/  
Regular

2.0 mm

**DE-1244**  
Large/  
Regular

2.0 mm

**DE-1245**  
Jumbo/  
Regular

### TIP SIZES FOR DISTAL OR SINGLE-END

1.5 mm      2.0 mm      2.8 mm



**DE-1246**  
Mini/  
Single-End

**DE-1247**  
Regular  
Single-End

**DE-1248**  
Large  
Single-End

1.5 mm



**DE-1249**  
Mini  
Distal

2.0 mm



**DE-1250**  
Regular  
Distal



**DE-1251**  
Amalgam  
Well



**DE-1240**  
Distal

Improves visibility  
and access to  
posterior regions.

**DE-1241**  
Single-End

**DE-1242**  
Double-End

## ROOT PLANNING FILES & BONE FILES

### ROOT PLANNING FILES



**DE-1252**  
Kramer-Nevins  
Bone Chisel



**DE-1253**  
Kramer-Nevins  
Bone Chisel



**DE-1254**  
Molt 18.5cm  
Auto Clavable  
Plastic Tips.



**DE-1255**  
Mead 18.5cm  
Non Auto Clavable  
Plastic Tips.



**DE-1256**  
Miller



**DE-1257**  
Miller

### BONE FILES



**DE-1258**  
Miller 21



**DE-1259**  
Miller 1X  
cross cut



**DE-1260**  
Miller 2X  
cross cut



**DE-1261**  
Miller 52



**DE-1262**  
Wahl 1

# ORTHODENTAL INSTRUMENTS



● QUALITY - ЯКІСТЬ ● PRECISION - ТОЧНІСТЬ ● ACCURACY - ПРАВИЛЬНІСТЬ ● DURABILITY - ЗНОСОСТІЙКІСТЬ



**STYLE A**

**STYLE B**

- Super-sharp diamond-boned cutters
- smooth ultra-polished and contoured edges
- brilliant corrosion resistant stainless steel finish
- superior T-12 stainless steel tool inserts
- sliding lock joint for balance & precision alignment

# ORTHODENTAL INSTRUMENTS

- Инструменты ортодонтические
- Instrumentos Ortodonticos
- Orthodontische Instrumente

- Инструменти ортодонтични
- Instruments Orthodontiques
- أدوات تقويم الأسنان



**DE-1277**  
Aluminum Height  
Gauge 0.22



**DE-1278**  
Aluminum Height  
Gauge 0.18



**DE-1279**  
Bone Bracket Gauge



**DE-1280**  
Bone Thickness Gauge  
40mm, 180mm



**DE-1281 OSTEOMETER**  
Measuring Forceps For Jaw  
Ridge Width measurement, scale  
on both sides, rustfree, autoclavable



**DE-1282**  
Direct bonding  
bracket holders,  
135mm



**DE-1283**  
Deluxe Bracket  
Holder Tweezers



**DE-1284**  
Direct bonding  
bracket holders,  
136mm



**DE-1285**  
Direct Bond  
Bracket Holder  
Tweezers,  
Small Tip



**DE-1286**  
Direct bonding  
bracket holders,  
140mm



**DE-1287**  
Direct bonding  
bracket holders,  
135mm



**DE-1288**  
Direct Bonding  
Bracket Holders,  
140mm

# ORTHODONTAL INSTRUMENTS

- Инструменты ортодонтические
- Instrumentos Ortodonticos
- Orthodontische Instrumente
- Инструменти ортодонтични
- Instruments Orthodontiques
- أدوات تقويم الأسنان



**DE-1289**  
Band seater auto cleavable



**DE-1290**  
Ortho light scaler double ended



**DE-1291**  
Ortho light scaler double ended



**DE-1292**  
Ortho light scaler double ended



**DE-1293**  
Twiel-on elastic module instrument



**DE-1294**  
Twiel-on elastic module instrument



**DE-1295**  
Schure Band Seater



**DE-1296**  
Ortho light scaler



**DE-1297**  
Ortho light scaler



**DE-1298**  
Ortho light scaler heavy



**DE-1299**  
Ortho instrument



**DE-1300**  
Ortho instrument



**DE-1301**  
Ortho Light Band Pusher Scaler



# ORTHODENTAL INSTRUMENTS

- Инструменты ортодонтические
- Instrumentos Ortodonticos
- Orthodontische Instrumente
- Инструменти ортодонтични
- Instruments Orthodontiques
- أدوات تقويم الأسنان



**DE-1302**  
Ortho Light double ended  
ligature director



**DE-1303**  
Ortho Light double ended  
ligature director scaler



**DE-1304**  
Ortho Light double ended ligature scaler director tivate coil spring  
are remove modules with one instruments



**DE-1305**  
Ortho band pusher scaler



**DE-1306**  
Ortho Light Band Pusher Scaler



**DE-1307**  
Ortho ligature director single ended



**DE-1308**  
Ortho Light double ended ligature  
director scaler



**DE-1309**  
Ortho Light double ended ligature scaler/director  
tivate coil spring are remove modules with one instruments



**DE-1310**  
Ortho Light double ended ligature director



**DE-1311**  
Ortholite Ligature Director Scaler



**DE-1312**  
Ortho light ligature director double ended



**DE-1313**  
Double ended cement spatula



**DE-1314**  
Ortho light scaler single ended

# PLIERS ORTHODONTAL & PROSTHETIES

- Щипцы для ортодонтии и протезирования
- Pincas pour l'orthodontie et la prothèse
- Zangen für Kieferorthopädie und Prothetik
- Щипці для ортодонції та протезування
- Alicates para ortodoncia y prótesis
- كمانشة لتقويم الأسنان بروسٹیتس

## BOX JOINT PLIERS

**DE-1315**  
Universal Dolphin Style  
Wire Bending & cutting pliers



**DE-1321**  
Bracket Removing Plier curved  
Bracket Removing Plier curved for  
easy removal of brackets in the  
posterior region. Length 130mm



**DE-1316 Band Removing Plier**  
The curved blade of the band  
removing plier can strip easily  
and gently remove directly to  
the tooth. Length 130mm



**DE-1322**  
Young Wire Bending &  
Loop Forming Pliers



**DE-1317**  
Tweed Loop  
forming Pliers



**DE-1323**  
Wire Bending &  
Loop Forming Pliers



**DE-1318**  
How Plier curved  
Universally usable tool for  
the multiband technology for  
wires up to .028".  
Length 130mm



**DE-1324**  
Adams, small wire bending  
and loop forming Pliers



**DE-1319 How Plier**  
Universally usable tool for the  
multiband technology for wires  
up to .028".  
Length 135mm



**DE-1325**  
Bracket Removing Plier Round Box  
Bracket removing plier for comfortable  
and quick removal of the brackets.  
Length 135mm



**DE-1320**  
Nance Loop  
forming Pliers



**DE-1326**  
Weingart Plier medium  
Weingart plier that are ideal due to  
their curved tip for setting sheets and  
is capable of bending the ends.  
Length 145mm



# PLIERS ORTHODONTAL & PROSTHETIES

- Щипцы для ортодонтии и протезирования
- Pincers pour l'orthodontie et la prothèse
- Zangen für Kieferorthopädie und Prothetik
- Щипці для ортодонтії та протезування
- Alicates para ortodoncia y prótesis
- كمانة للقويم الأسنان بروستھتیس

## BOX JOINT PLIERS

### DE-1327 Adams Plier Round Box

Adams pliers for bending wire arches and bends right angles for wires up to .022", .025 tip to beak. Length 125mm

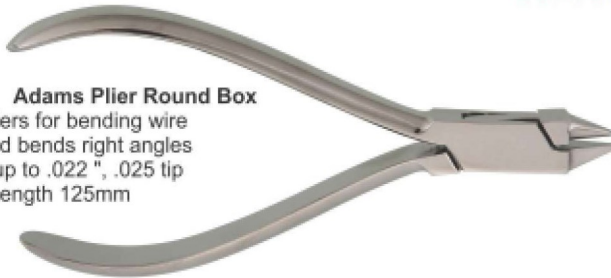

### DE-1333 Adams Plier

Adams pliers for bending wire arches and bends right angles for wires up to .022", .025 tip to beak. Length 125mm



### DE-1328 Falcon Beak Contouring Pliers.



### DE-1334 Tweed Loop Formin Pliers



### DE-1329 wires up to 0.020" / 0.7mm.



### DE-1335 Bird Beak Plier Standard

Bird Beak Wire bending plier without notches, which is suitable as a universal utility tool. Length 125mm

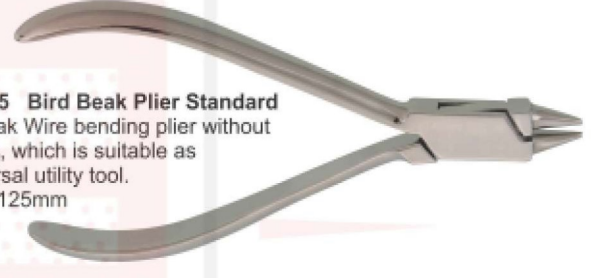

### DE-1330 Johnson Contouring Pliers



### DE-1336 Mini Ligature cutters



### DE-1331 Aderer Large wire bending and loop forming pliers



### DE-1337 Small Fluch-cut distal and cutting Pliers with safety hold fitted with un-breakable, corrosion resistant and durable stainless steel tips



### DE-1332 Tweed / angle rectangular arch forming & Torquing pliers



### DE-1338 Large Fluch-cut distal and cutting Pliers with safety hold fitted with un-breakable, corrosion resistant and durable stainless steel tips



# PLIERS ORTHODONTAL & PROSTHETIES

- Щипцы для ортодонтии и протезирования
- Pincers pour l'orthodontie et la prothèse
- Zangen für Kieferorthopädie und Prothetik
- Щипці для ортодонтії та протезування
- Alicates para ortodoncia y prótesis
- كمشة لتقويم الأسنان بروستھتیس

## BOX JOINT PLIERS

**DE-1339**  
Tweed / Angel  
1.78mm (.070") wide tips arch  
forming and torquing pliers



**DE-1340**  
Tweed / Angel  
1.78mm (.070") wide tips arch  
forming and torquing pliers



**DE-1341**  
Lingual / Palatal arch  
forming pliers



**DE-1342**  
Aderer  
Facebow loop forming Pliers



**DE-1343**  
Waldsavhs wire bending  
and cutting pliers



**DE-1344 Aderer Plier**  
For the manufacturing of appliances and  
activation of wires for wires up to .030" .fine  
tip and up to .036" mean tip.  
Length 130mm



**DE-1345**  
Contouring Plier



**DE-1346**  
Bands & Crowns Plier  
in order to skirt



**DE-1347**  
Ligature Forming Pliers

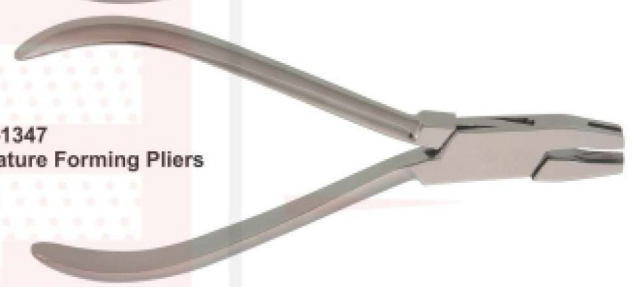

**DE-1348**  
for double back and triple back  
bands in 0.30" / 0.76mm & 0.36"  
/ 0.91mm lingual arch wires



**DE-1349**  
Bird Beak Wire Bending  
& cutting pliers



**DE-1350**  
Weingart Plier medium  
Weingart plier that are ideal due to  
their curved tip for setting sheets and  
is capable of bending the ends.  
Length 145mm

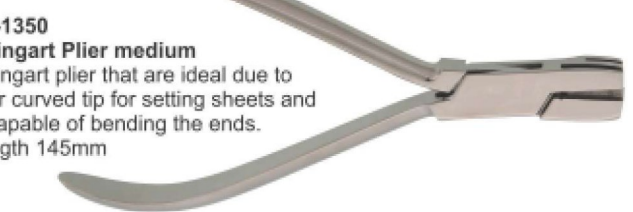

# PLIERS ORTHODONTAL & PROSTHETIES

- Щипцы для ортодонтии и протезирования
- Pincas pour l'orthodontie et la prothèse
- Zangen für Kieferorthopädie und Prothetik
- Щипці для ортодонції та протезування
- Alicates para ortodoncia y prótesis
- كمامشة للقويم الأسنان بروستھتیس

## LAP JOINT PLIERS



**DE-1351**  
Distal End Cutter  
Regular with T.C

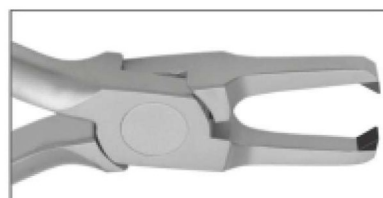

**DE-1358**  
Bracket Remover Pliers  
Straight With T.C

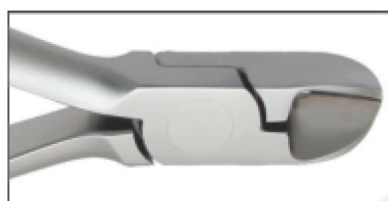

**DE-1352**  
Hard Wire Cutter With T.C



**DE-1359**  
Bird Beak Plier With TC



**DE-1353**  
Ligature Cutter Angled  
15° With T.C

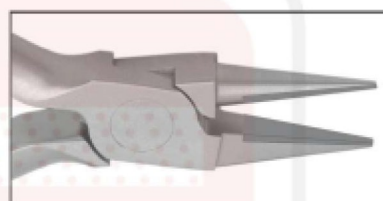

**DE-1360**  
Light Wire Bird Beak  
Long Plier With TC



**DE-1354**  
Light Wire Cutter Micro  
With T.C

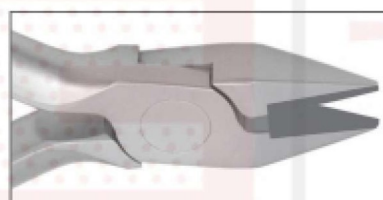

**DE-1361**  
Adam Plier With TC

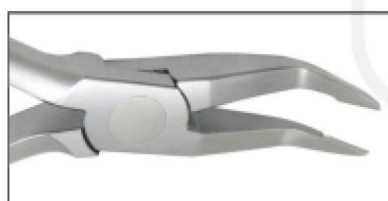

**DE-1355**  
Reversed Ligature  
Cutter Angled  
40° With T.C

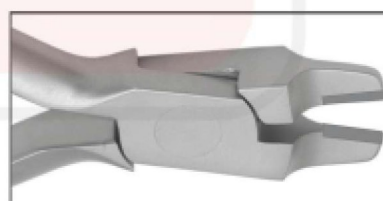

**DE-1362**  
Tweed Arch Forming Plier  
1.78mm With TC

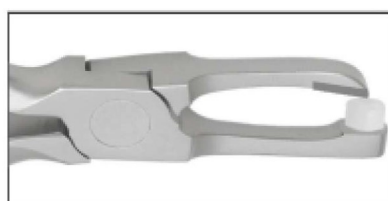

**DE-1356**  
Posterior Band Remover Pliers  
Long With T.C



**DE-1363**  
Weingart Plier Slim  
With TC

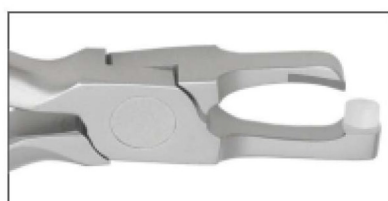

**DE-1357**  
Posterior Band Remover Pliers  
Medium With T.C

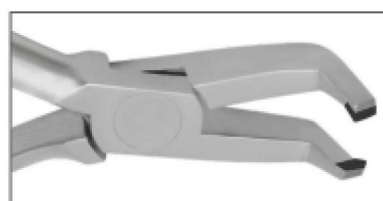

**DE-1364**  
Bracket Remover Pliers  
Angled With T.C

# PLIERS ORTHODONTAL & PROSTHETIES

- Щипцы для ортодонтии и протезирования
- Pincers pour l'orthodontie et la prothèse
- Zangen für Kieferorthopädie und Prothetik
- Щипці для ортодонції та протезування
- Alicates para ortodoncia y prótesis
- كمشة لتقويم الأسنان برومشتيس

## LAP JOINT PLIERS

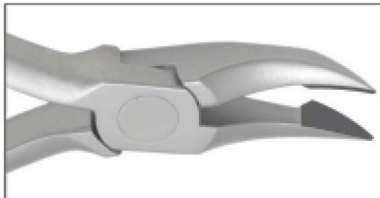

**DE-1365**  
Weingart Plier Regular  
With TC

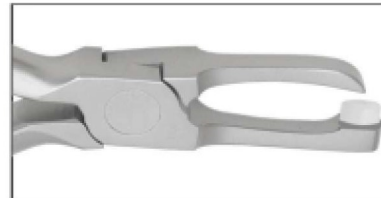

**DE-1372**  
Posterior Bend Remover  
Plier Long

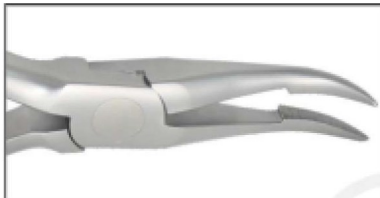

**DE-1366**  
Weingart General Utility Plier  
Long Mouth With TC

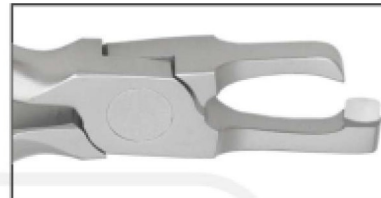

**DE-1373**  
Posterior Bend Remover  
Plier Short

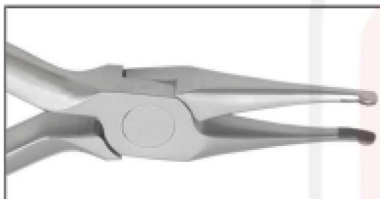

**DE-1367**  
How Plier Straight  
With TC

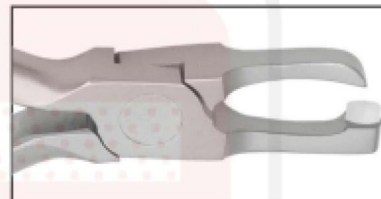

**DE-1374**  
Posterior Bend Remover  
Plier Medium

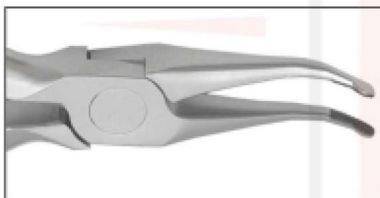

**DE-1368**  
How Plier Curved  
With TC

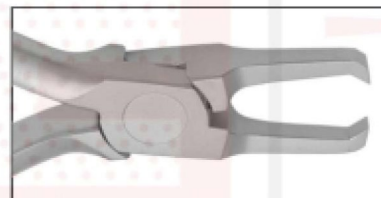

**DE-1375**  
Bracket Remover Plier  
Straight

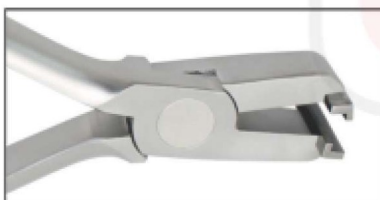

**DE-1369**  
Step Pliers with T.C  
0.5mm

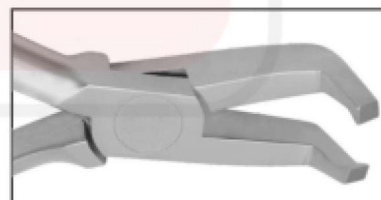

**DE-1376**  
Bracket Remover  
Angulated  
Plier

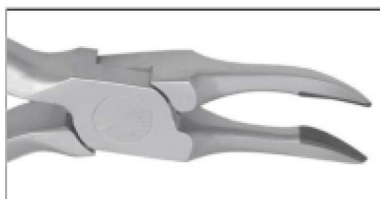

**DE-1370**  
Weingart Plier Utility  
With TC

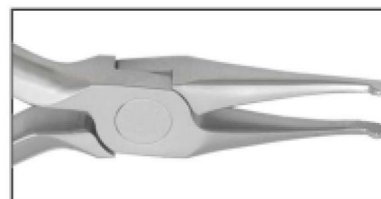

**DE-1377**  
How Plier Straight

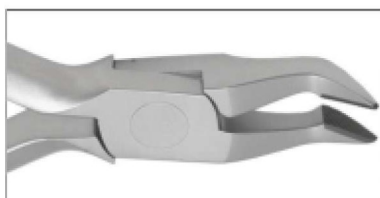

**DE-1371**  
Weingart Plier Universal  
With TC 45°



**DE-1378**  
Bird Beak Angled  
Bending Plier

# PLIERS ORTHODONTAL & PROSTHETIES

- Щипцы для ортодонтии и протезирования
- Pincas pour l'orthodontie et la prothèse
- Zangen für Kieferorthopädie und Prothetik
- Щипці для ортодонції та протезування
- Alicates para ortodoncia y prótesis
- كمشة لتقويم الأسنان بروستھتیس

## LAP JOINT PLIERS

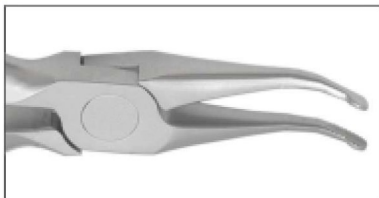

**DE-1379**  
How Plier Curved

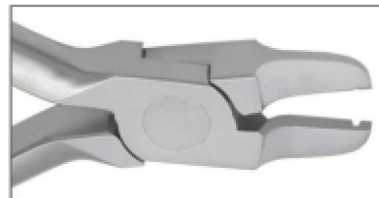

**DE-1386**  
Tweed Cutter Plier With Groove



**DE-1380**  
Hammer Head Tie Back Plier



**DE-1387**  
Round Nose Plier

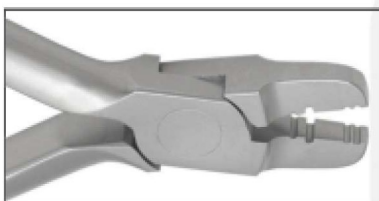

**DE-1381**  
Arch Forming Pliers

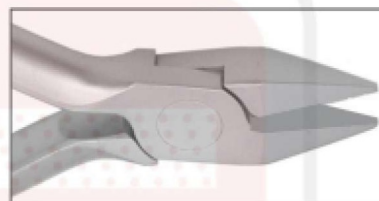

**DE-1388**  
Adam Plier

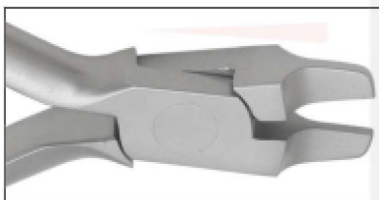

**DE-1382**  
Regular Tweed Arch Forming Pliers 1.78mm

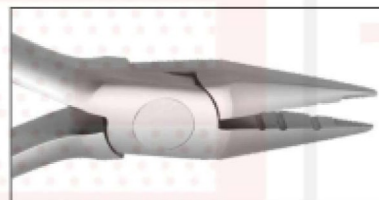

**DE-1389**  
Jara Beak Plier



**DE-1383**  
Bird Beak with Cutter Pliers 3 Groove

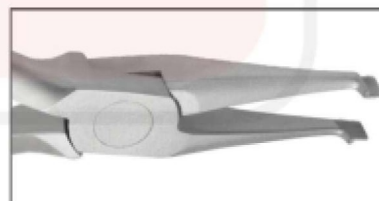

**DE-1390**  
Band Seating Plier



**DE-1384**  
Light Wire Bird Beak Pliers With Groove

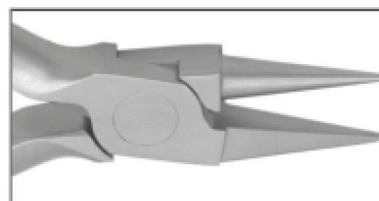

**DE-1391**  
Light Wire Bird Beak Long Plier



**DE-1385**  
Tweed Loop Plier

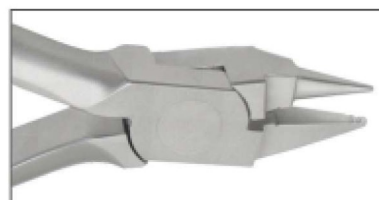

**DE-1392**  
Light Wire plier two step groove 0.51mm/.020"

# PLIERS ORTHODONTAL & PROSTHETIES

- Щипцы для ортодонтии и протезирования
- Pincers pour l'orthodontie et la prothèse
- Zangen für Kieferorthopädie und Prothetik

- Щипці для ортодонції та протезування
- Alicates para ortodoncia y prótesis
- كمامشة لتقويم الأسنان برومشتيس

## LAP JOINT PLIERS



**DE-1393**  
Ball Hook Crimping Plier



**DE-1401**  
Wingurt Utility Plier

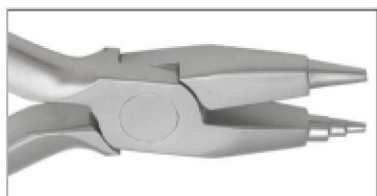

**DE-1394**  
Marcotte Looping Plier

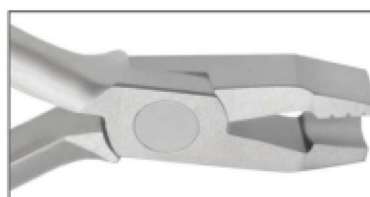

**DE-1402**  
De La Rosa Pliers with Grooved

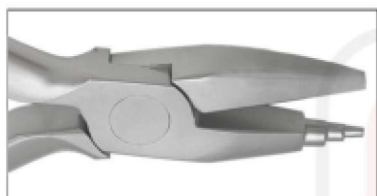

**DE-1395**  
Tweed Loop Plier

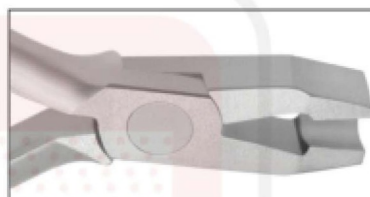

**DE-1403**  
De La Rosa Pliers

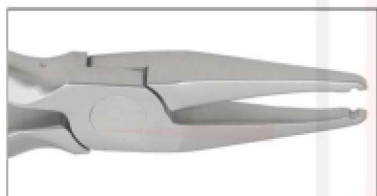

**DE-1396**  
Palatal Arch Plier



**DE-1404**  
Crown and Band Contouring Pliers

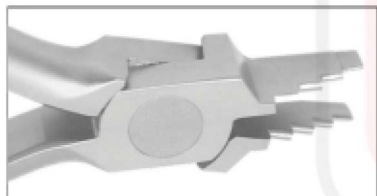

**DE-1397**  
Nance Plier

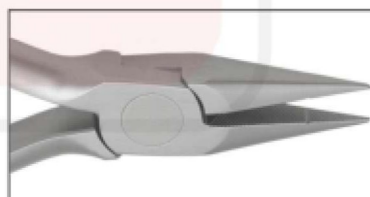

**DE-1405**  
Flat Nose Plier with Serration

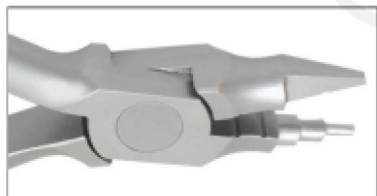

**DE-1398**  
Young Plier with Grooved



**DE-1406**  
Flat Nose Plier Smooth

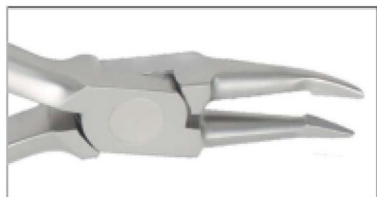

**DE-1399**  
Wingurt Plier Slim

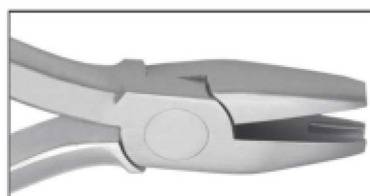

**DE-1407**  
Stop V Bending Plier



**DE-1400**  
Tweed loop Forming Plier TC.



# DISTAL, WIRE CUTTER

## PLIERS ORTHODONTAL & PROSTHETIES

- Щипцы для ортодонтии и протезирования
- Pincers pour l'orthodontie et la prothèse
- Zangen für Kieferorthopädie und Prothetik
- Щипці для ортодонції та протезування
- Alicates para ortodoncia y prótesis
- كمامشة لتقويم الأسنان بروسیتیس

### LAP & L-KEY JOINT PLIERS

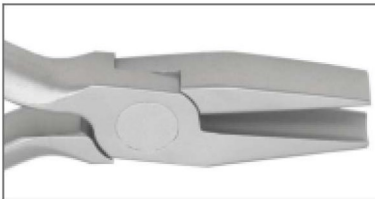

**DE-1408**  
Hollowchop Contouring  
Pliers

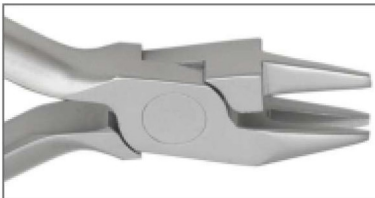

**DE-1409**  
Lap-Joint Three Prong Plier



**DE-1410**  
Three Prong Pliers Regular

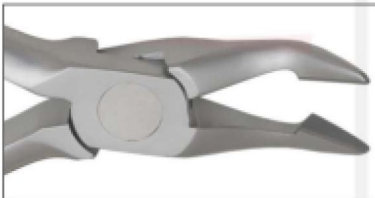

**DE-1411**  
Lingual Plier Weingart  
Regular Long Handle 35°

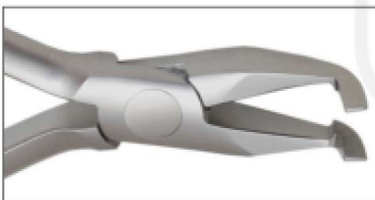

**DE-1412**  
Lingual Plier Long Handle  
90° Angled

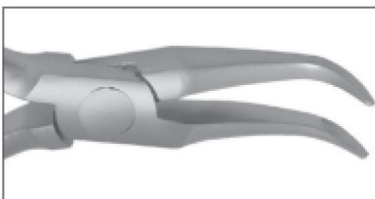

**DE-1413**  
Lingual Weingart Plier Fine  
Long Handle 60° Angled



**DE-1414**  
Direct Bonding Bracket  
Remover Plier TC.



**DE-1415**  
Pin & Ligature Cutters  
TC.



**DE-1416**  
Mini Pin & Ligature  
Cutter TC.



**DE-1417**  
Standard Ligature  
Cutter TC.



**DE-1418**  
V Bend Stop Plier  
TC.



**DE-1419**  
Angled Direct Bond Bracket  
Remover TC.

# DISTAL, WIRE CUTTER

## BRACKET REMOVER PLIERS

**DE-1420**  
Distal end Cutter, Safety Hold Plier  
(Ideal for Cutting Wire) TC.



**DE-1427**  
Hard wire cutters



**DE-1421**  
Hook Crimping Plier Angled  
Straight TC.



**DE-1428**  
Elastic Separating Plier  
Round Handle



**DE-1422**  
3 Prong Clasp Adjustable  
Plier TC.



**DE-1429**  
Elastic  
Separating Plier



**DE-1423**  
Utility Plier Weingart TC.



**DE-1430**  
**DE-1431**  
Smaha  
Elastomeric  
ligature  
placing forceps  
140 mm



**DE-1424**  
Direct Bracket Remover  
TC.



**DE-1432**  
Elastomeric  
ligature placing  
forceps with  
groove  
Falcon 140 mm

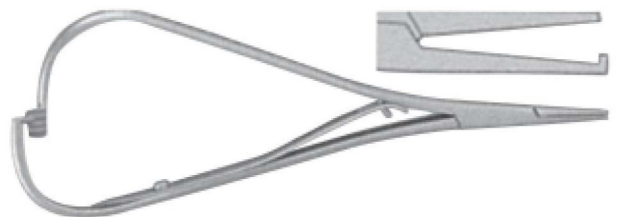

**DE-1425**  
Straight Direct Bond Bracket  
Remover TC.



**DE-1433**  
Elastomeric  
ligature placing  
forceps with  
groove  
Falcon 140 mm

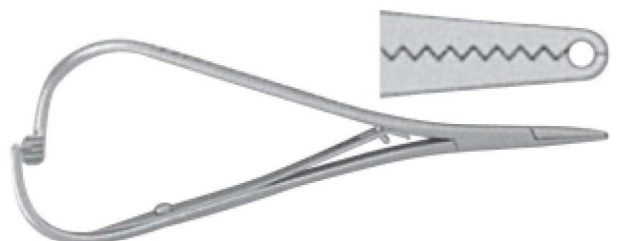

**DE-1426**  
Pin Holding Plier TC.



# DENTAL IMPLANT INSTRUMENTS

## Normal Anatomy – Dental Implants

Bone Level Normal  
(No Bone Loss)

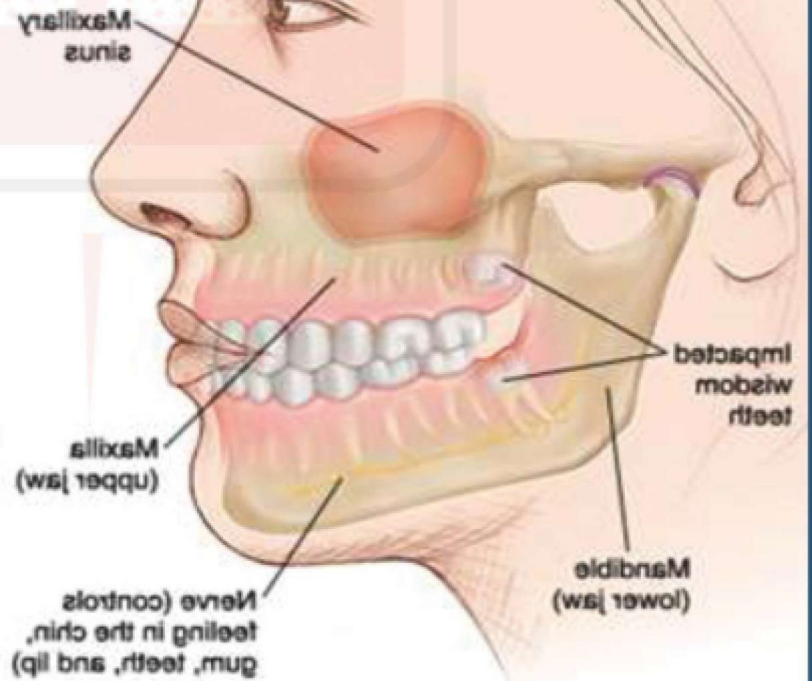
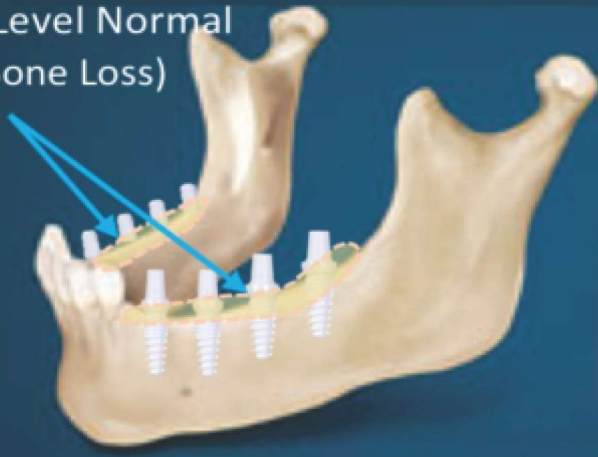

# IMPLANTOLOGY

- Инструменты для имплантологии
  - Implantologie
  - Implantologie
- Инструменти для імплантології
  - Implantologia
  - زراعة الأسنان

## IMPLANT GAGES



**DE-1434**  
**Multifunctional Meter**  
 Length 90 mm,  
 different sizes,  
 8-10-11mm,  
 corrosion-resistant

**DE-1435**  
**Multifunctional Meter**  
 Length 90 mm,  
 different sizes,  
 5-13-15-17 mm,  
 corrosion-resistant

**DE-1436**  
**Measuring Probe**  
 Length 170 mm,  
 hand shape or flexible  
 (6-8-10-14-16 mm),  
 corrosion-resistant

**DE-1437**

**DE-1438**

**DE-1439**

**DE-1440**

## IMPLANT GAGES



**DE-1441**

**DE-1442**

**DE-1443**

# IMPLANTOLOGY

- Инструменты для имплантологии
- Implantologie
- Implantologie

- Инструменти для імплантології
- Implantoloia
- زراعة الأسنان



**DE-1444**  
Clamp, Osteometer  
Length about 155 mm,  
ridge width measurement,  
two-sided scale,  
measuring  
range 0 - 25 mm



**DE-1445**  
Measuring Loop  
straight length 90 mm,  
measuring range  
0 - 40 mm,

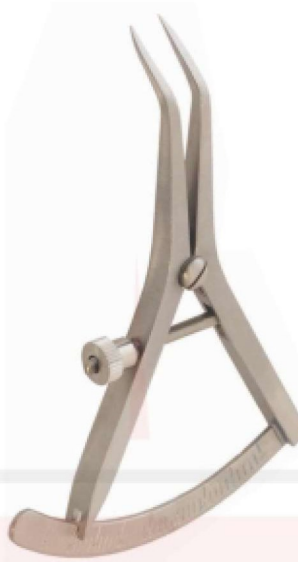

**DE-1446**  
Measuring Loop  
angled, length 90 mm,  
measuring range  
0 - 40 mm,



**DE-1447**  
Measuring loop, Castroviejo  
angled, length 175 mm,  
measuring range 0 - 40 mm,  
with window



**DE-1448**  
Boley Gauge  
Stainless Steel



**DE-1449**  
Measuring Loop  
angled, length  
175 mm,  
measuring range  
0 - 40 mm,



**DE-1450**  
Measuring Loop  
straight length  
175 mm,  
measuring range  
0 - 40 mm,



**DE-1451**  
Fig. 1  
Iwanson  
spring caliper  
For metal and  
porcelain.



**DE-1452**  
Fig. 2  
Iwanson  
spring caliper  
For wax.



**DE-1453**  
Bone Thickness Gauge  
40mm, 180mm



**DE-1454**  
Gauge  
for measuring  
distances  
(0 - 90 mm),

# IMPLANTOLOGY

- Инструменты для имплантологии
- Implantologie
- Implantologie

- Инструменти для імплантології
- Implantologia
- زراعة الأسنان

## BLACK TITANIUM COLOUR COATED INSTRUMENTS

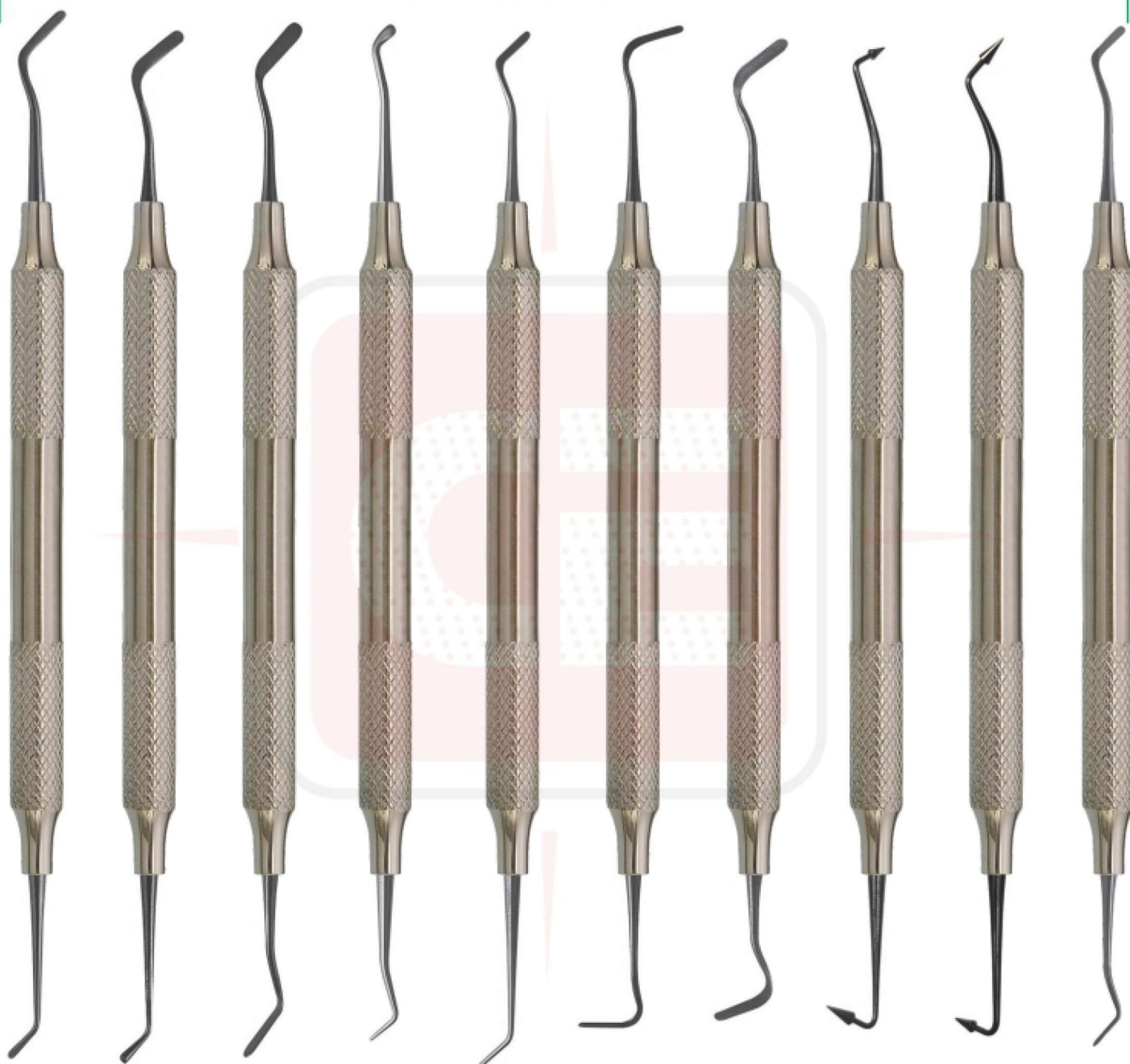

DE-1455 #1  
DE-1456 #2  
DE-1457 #3 Extra-Flex  
DE-1458 Micro-Mini  
DE-1459 Mini 1  
DE-1460 Mini 4 Extra-Flex  
DE-1461 #4 Extra-Flex  
DE-1462 #5 Flexi-Thin  
DE-1463 #6 Flexi-Thin  
DE-1464 Mini 3 Extra-Flex

# IMPLANTOLOGY

- Инструменты для имплантологии
- Instrumentologie
- Implantologie
- Инструменти для імплантології
- Implantologia
- زراعة الأسنان

## BLACK TITANIUM COLOUR COATED INSTRUMENTS

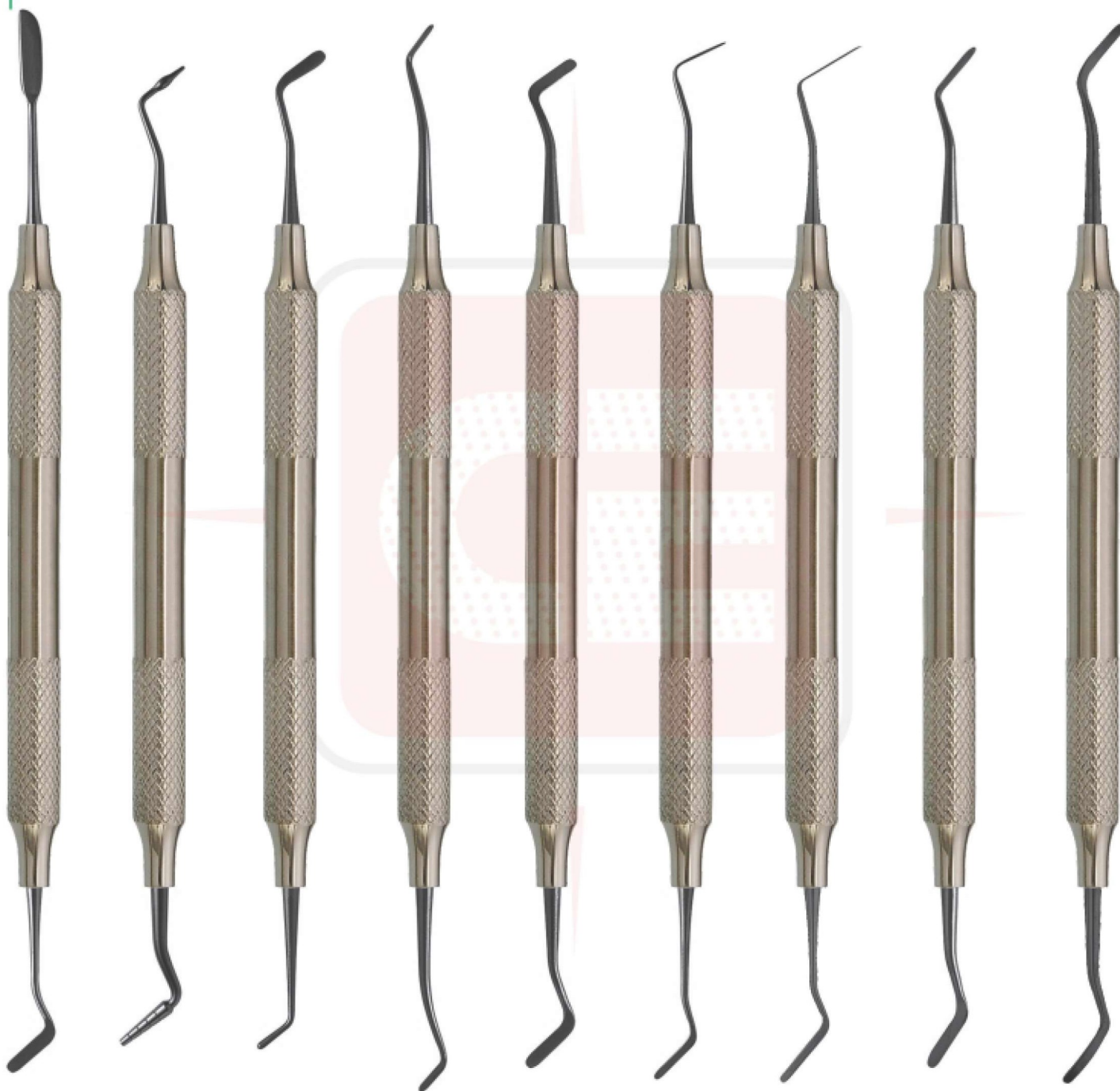

DE-1465 AB1 Boghosian  
DE-1466 AB2 Boghosian  
DE-1467 W3  
DE-1468 8A  
DE-1469 4/5 Gregg  
DE-1470 Interproximal Carver  
DE-1471 Interproximal Carver, Long  
DE-1472 A6  
DE-1473 Contouring instrument

# IMPLANTOLOGY

- Инструменты для имплантологии
- Implantologie
- Implantologie
- Инструменти для імплантології
- Implantologia
- زراعة الأسنان

## BLACK TITANIUM COLOUR COATED INSTRUMENTS

### BURNISHERS

### FREEDMAN BURNISHERS

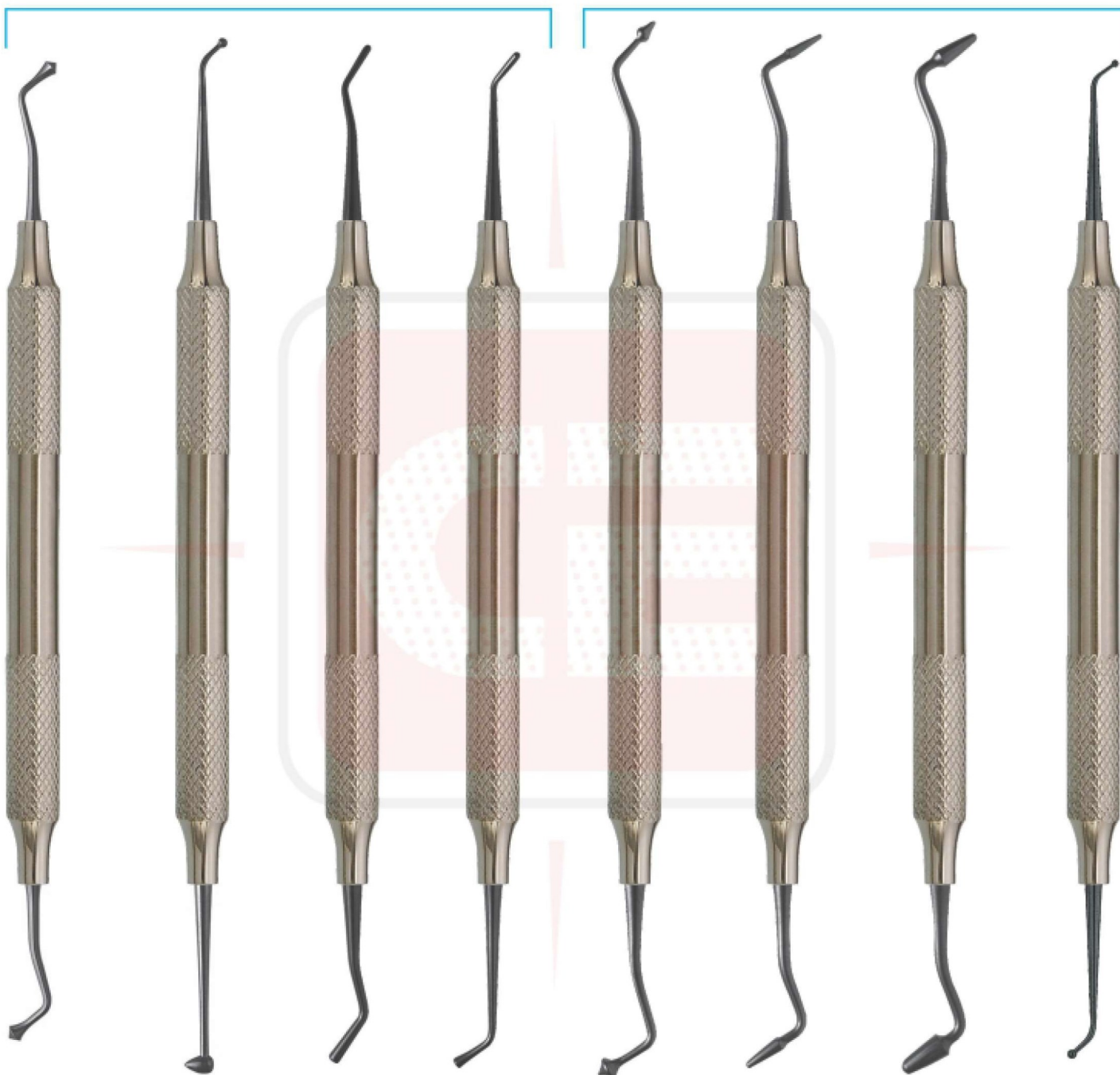

DE-1474  
21B

DE-1475  
27/29

DE-1476  
2  
Ladmore

DE-1477  
3  
Ladmore

DE-1478  
Freedman  
"Duckhead"

DE-1479  
Freedman  
Small Contact  
Forming

DE-1480  
Freedman  
Large Contact  
Forming

DE-1481  
Small/  
Medium Ball  
Burnisher



# IMPLANTOLOGY

- Инструменты для имплантологии
- Implantologie
- Implantologie
- Инструменти для имплантології
- Implantologia
- زراعة الأسنان

## BLACK TITANIUM COLOUR COATED INSTRUMENTS

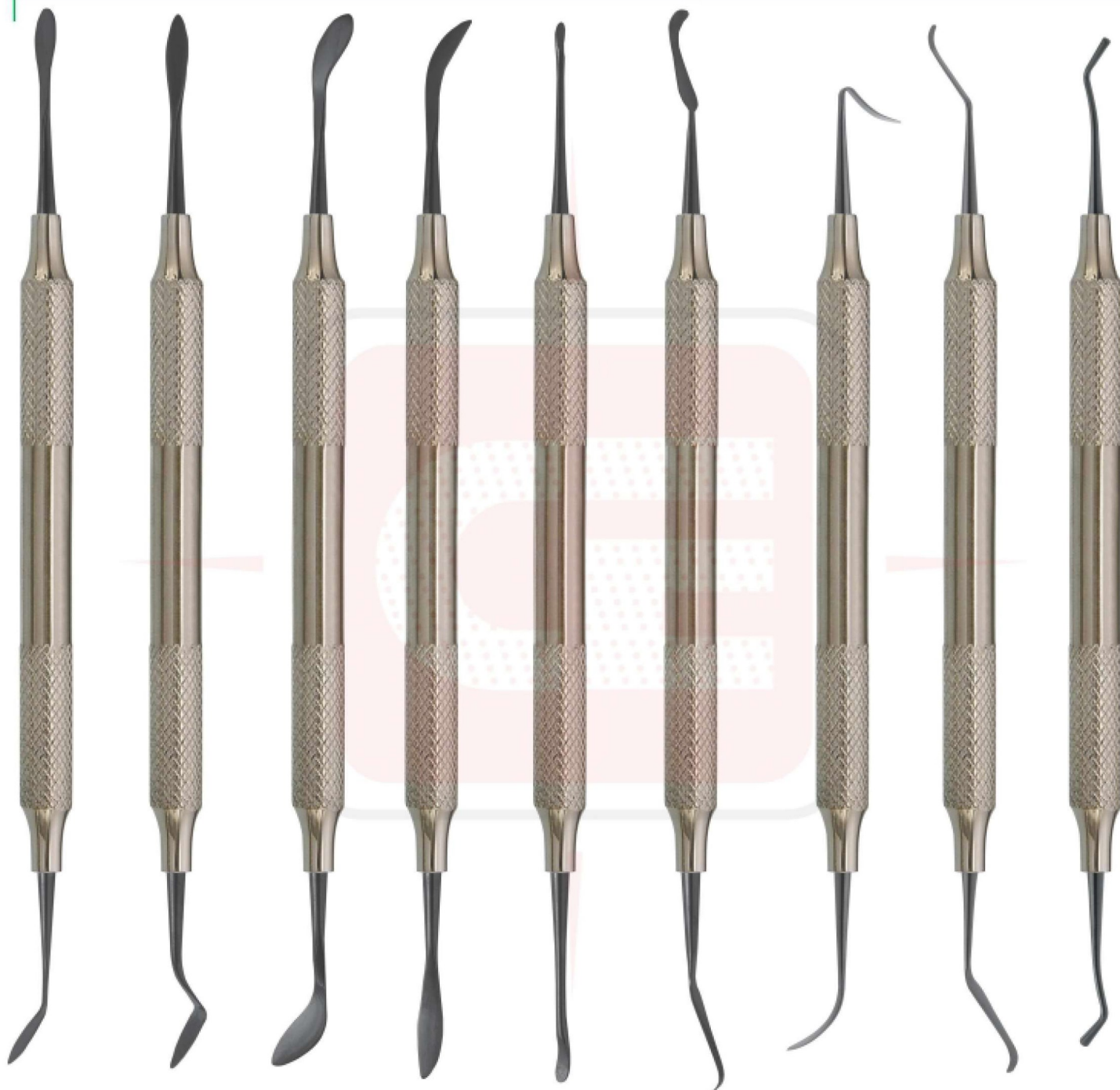

**DE-1482**  
A  
Cosmetic  
Contouring

**DE-1483**  
B  
Cosmetic  
Contouring

**DE-1484**  
C  
Cosmetic  
Contouring

**DE-1485**  
D  
Cosmetic  
Contouring

**DE-1486**  
E  
Cosmetic  
Contouring

**DE-1487**  
F  
Cosmetic  
Contouring

**DE-1488**  
Marginal Ridge  
& Embrasure  
Shaping Instrument

**DE-1489**  
Occlusal  
Anatomy  
Instrument

**DE-1490**  
Composite  
Packing  
Instrument

# IMPLANTOLOGY

- Инструменты для имплантологии
- Implantologie
- Implantologie
- Инструменти для імплантології
- Implantologia
- زراعة الأسنان

## BLACK TITANIUM COLOUR COATED INSTRUMENTS

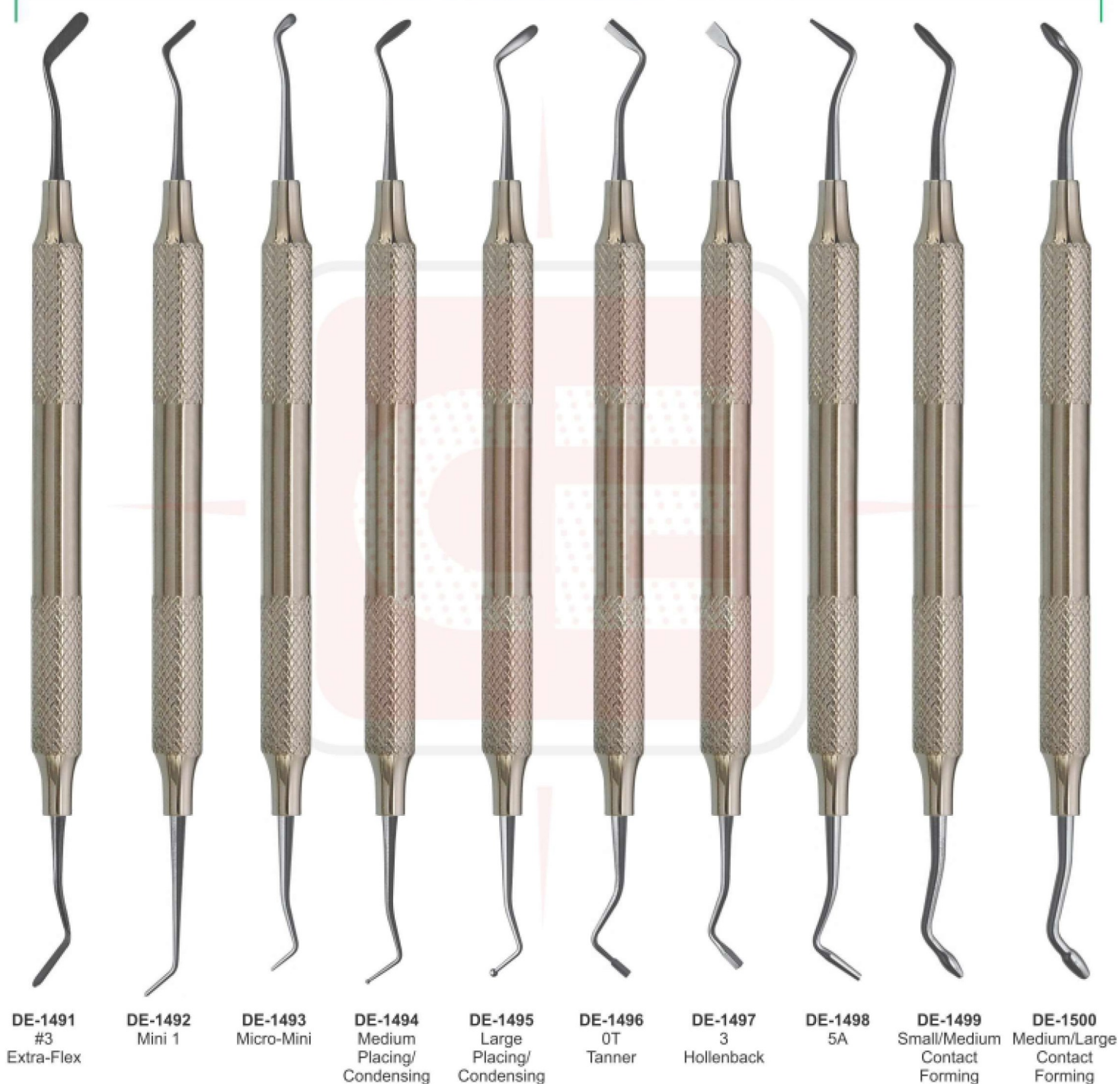

# IMPLANTOLOGY

- Инструменты для имплантологии
  - Implantologie
  - Implantologie
- Инструменти для імплантології
  - Implantologia
  - زراعة الأسنان

**SINUS LIFT INSTRUMENTS HOLLOW HANDLE 9.5MM LENGTH 170MM**

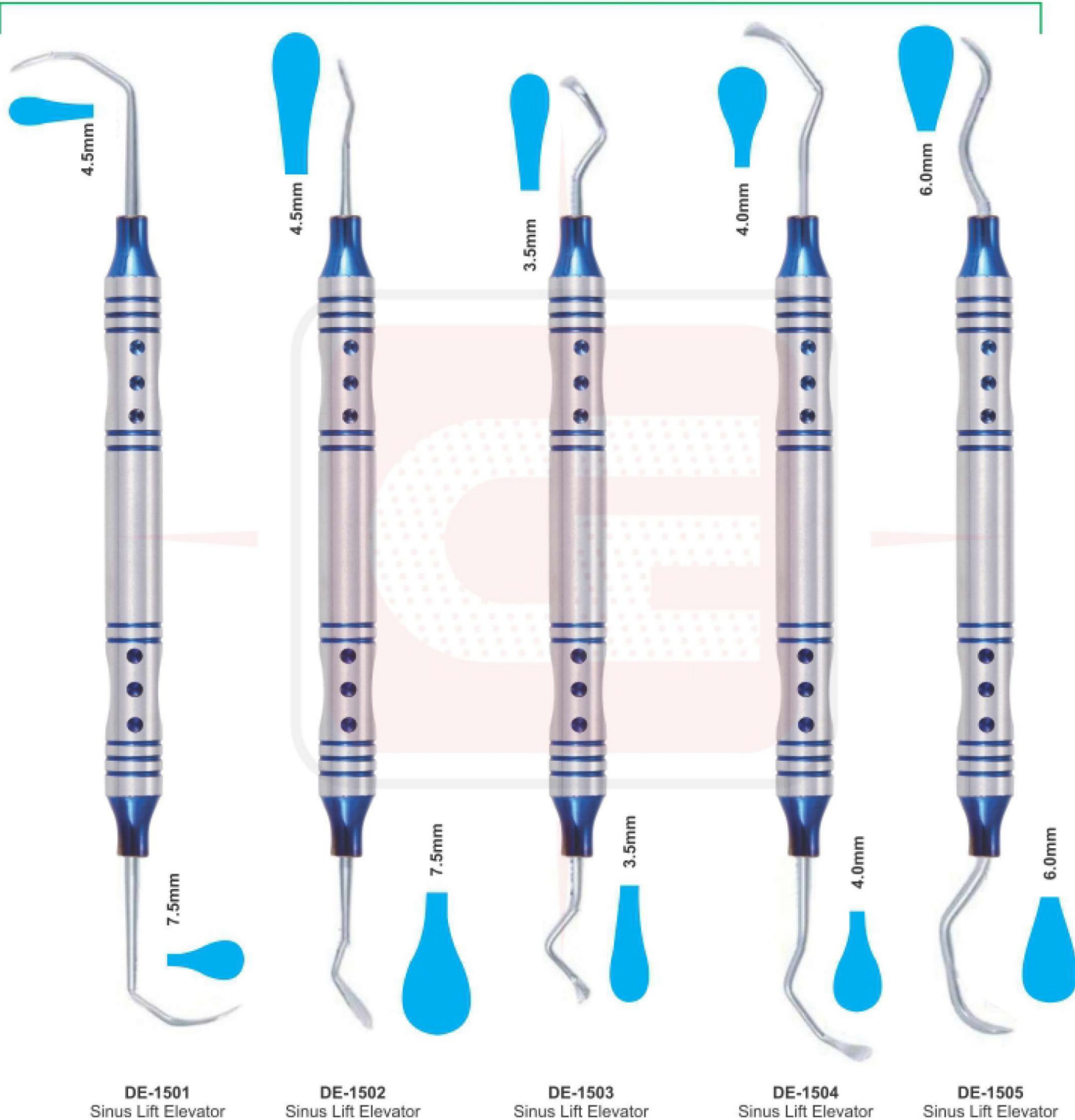

# IMPLANTOLOGY

- Инструменты для имплантологии
- Implantologie
- Implantologie
- Инструменти для імплантології
- Implantologia
- زراعة الأسنان

## SINUS LIFT INSTRUMENTS HOLLOW HANDLE 9.5MM LENGTH 170MM

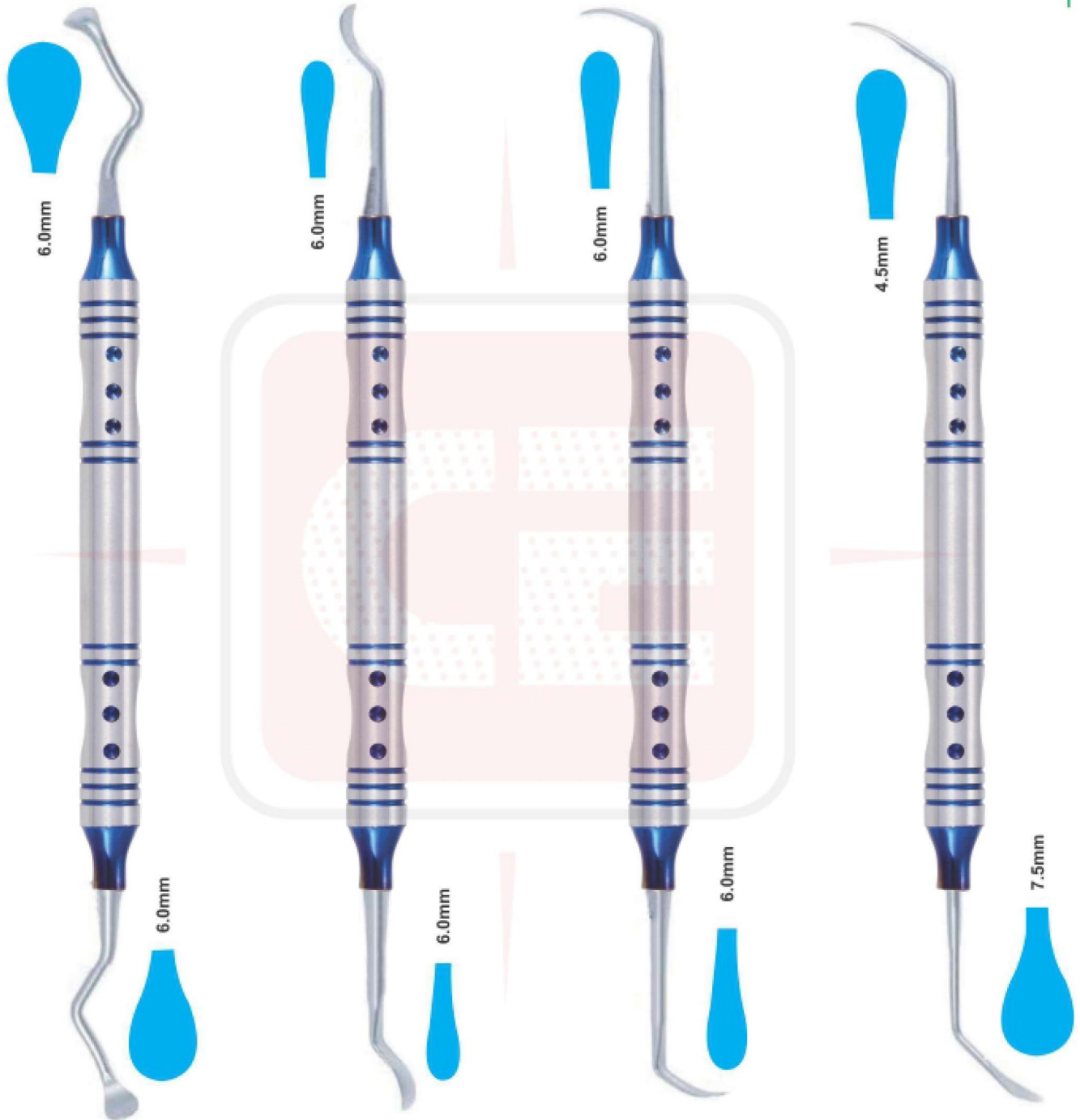

**DE-1506**  
Sinus Lift Elevator

**DE-1507**  
Sinus Lift Elevator

**DE-1508**  
Sinus Lift Elevator

**DE-1509**  
Sinus Lift Elevator

# IMPLANTOLOGY

- Инструменты для имплантологии
  - Implantologie
  - Implantologie
- Инструменти для імплантології
  - Implantologia
  - زراعة الأسنان

**IMPLANT SINUS LIFT INSTRUMENTS HOLLOW HANDLE 9.5MM LENGTH 170MM**



**DE-1510**  
Acute 6577

**DE-1511**  
Sinus1

**DE-1512**  
Sinus2

**DE-1513**  
Sinus3,  
Obtuse 6578

**DE-1514**  
Sinus4

**DE-1515**  
Sinus5

**DE-1516**  
Sinus6

**DE-1517**  
Sinus7

## IMPLANTOLOGY

- Инструменты для имплантологии
- Implantologie
- Implantologie
- Инструменти для імплантології
- Implantologia
- زراعة الأسنان

### SINUS LIFT INSTRUMENTS HOLLOW HANDLE 9.5MM LENGTH 170MM

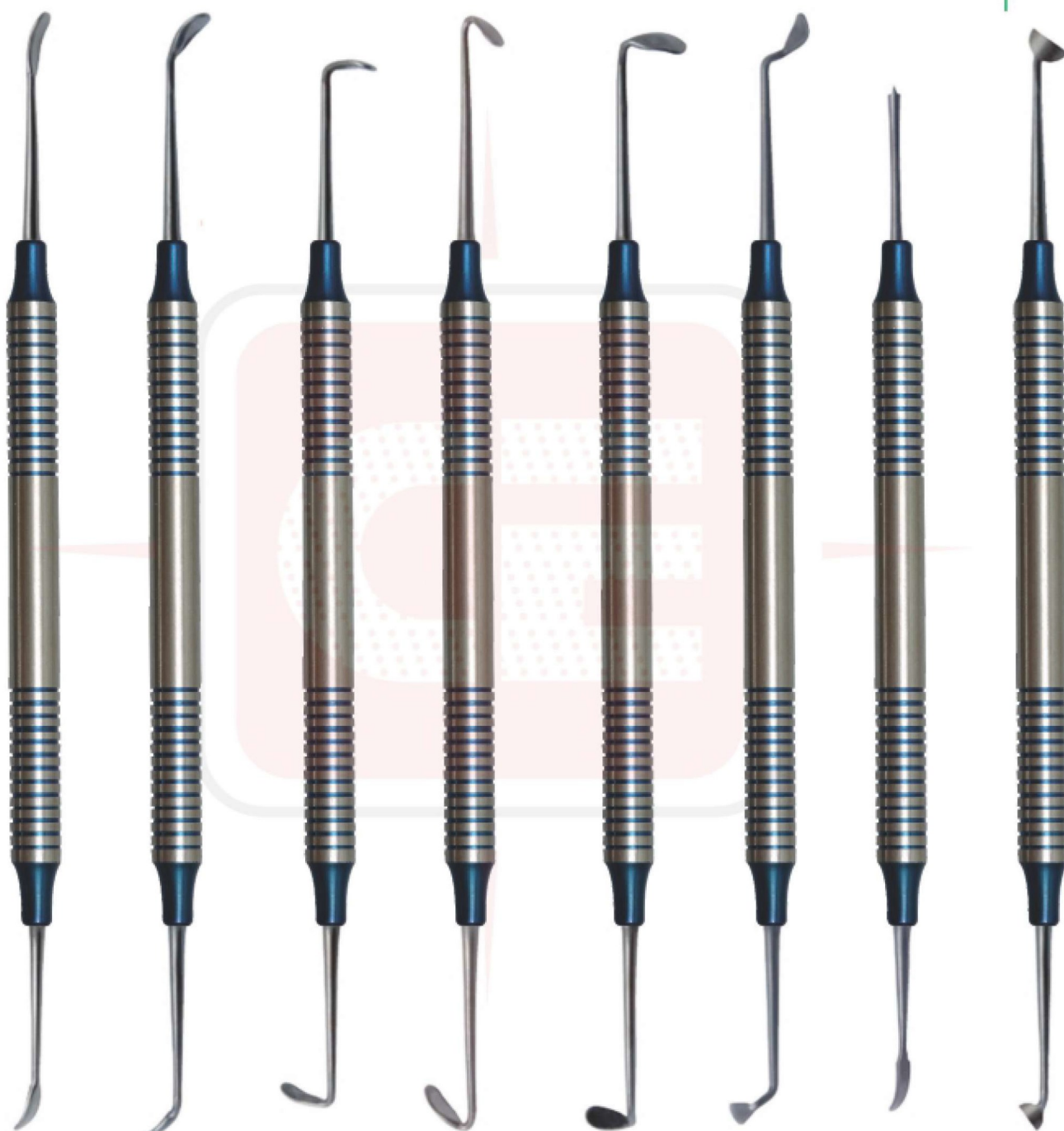

DE-1518  
Sinuslift 1

DE-1519  
Sinuslift 2

DE-1520  
Sinuslift 3

DE-1521  
Sinuslift 4

DE-1522  
Sinuslift 5

DE-1523  
Sinuslift 6

DE-1524  
Membrane  
3Positioning 1

DE-1525  
Condenser 1

# IMPLANTOLOGY

- Инструменты для имплантологии
- Implantologie
- Implantologie

- Инструменти для имплантології
- Implantologia
- زراعة الأسنان

**Sinus Lift Instrument,**  
Flexible Sinus Lift instruments  
reduce the risk of perforation of the  
"Schneider's membrane"

**Sinus Lift Elevator,**  
10 mm Straight grip  
Length 175 mm, Sinus lift elevators, dull,  
for gentle peeling and lifting the  
Schneider membrane

**Sinus lift instrument**  
10 mm Straight grip Length 180 mm,  
Buser (B1, B2, B3) raspatories,  
quality medical stainless steel,  
corrosion-resistant



DE-1526  
Fig. 1

DE-1527  
Fig. 2

DE-1528  
Fig. 3

DE-1529  
Fig. 1

DE-1530  
Fig. 2

DE-1531  
Fig. 3

DE-1532  
B01

DE-1533  
B02

DE-1534  
B03

# IMPLANTOLOGY

- Инструменты для имплантологии
- Инструменти для імплантології
- Implantologie
- Implantologia
- Implantologie
- زراعة الأسنان

Sinus lift instrument 10 mm Straight grip Sinus lift elevators, blunt or sharply curved (H01, H02, K03, K04, K78, K77)

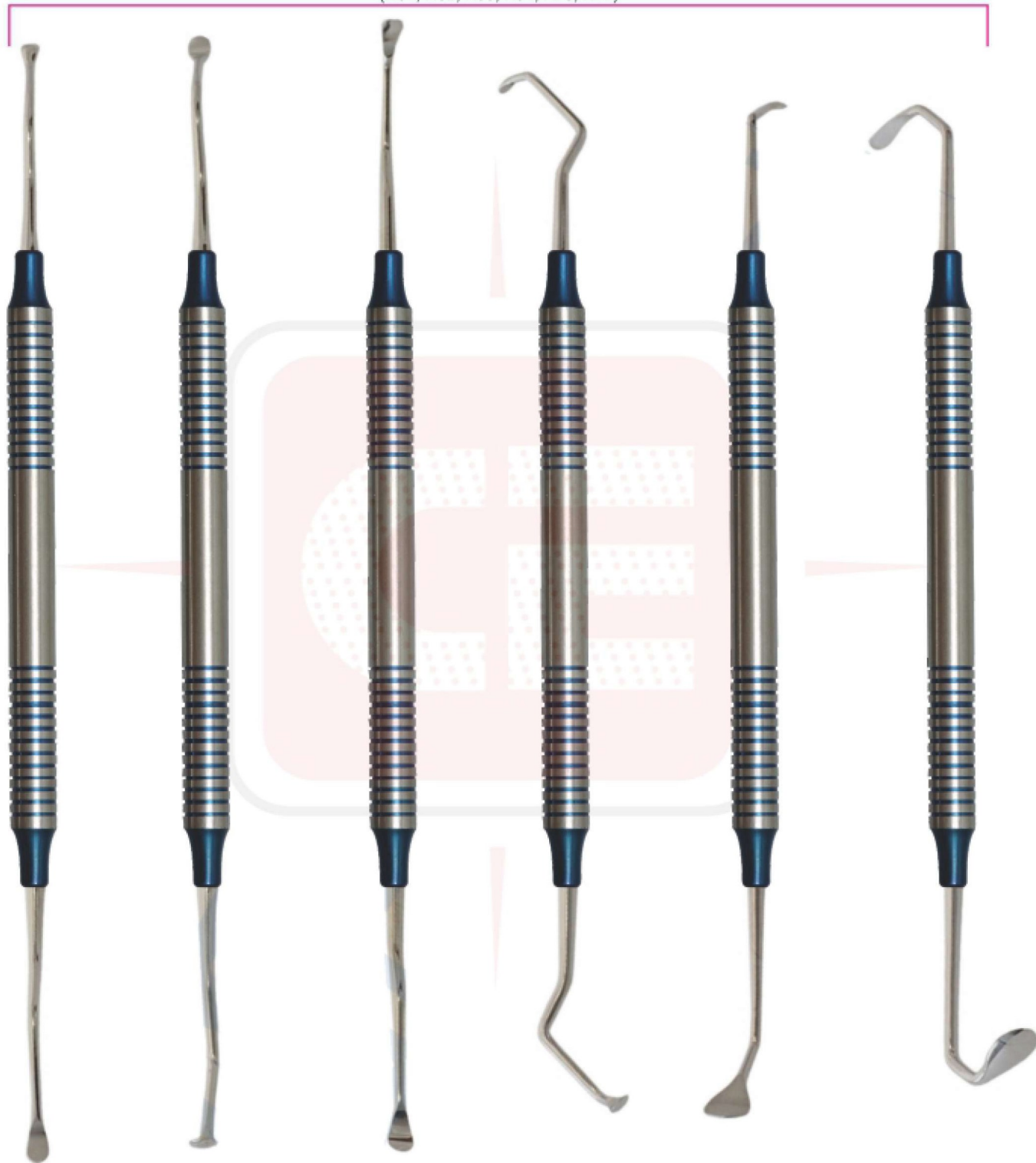

**DE-1535**  
Sinus lift instrument  
H01

**DE-1536**  
Sinus lift instrument  
H02

**DE-1537**  
Sinus lift instrument  
K03

**DE-1538**  
Sinus lift instrument  
K04

**DE-1539**  
Sinus lift instrument  
K78

**DE-1540**  
Sinus lift instrument  
K77



## IMPLANTOLOGY

- Инструменты для имплантологии
- Implantologie
- Implantologie
- Инструменти для імплантології
- Implantologia
- زراعة الأسنان

### SINUS LIFT INSTRUMENT

Sinus Lift Elevators, 10 mm Hollow Handle length 170mm Blunt Curved Set of 6 Pcs

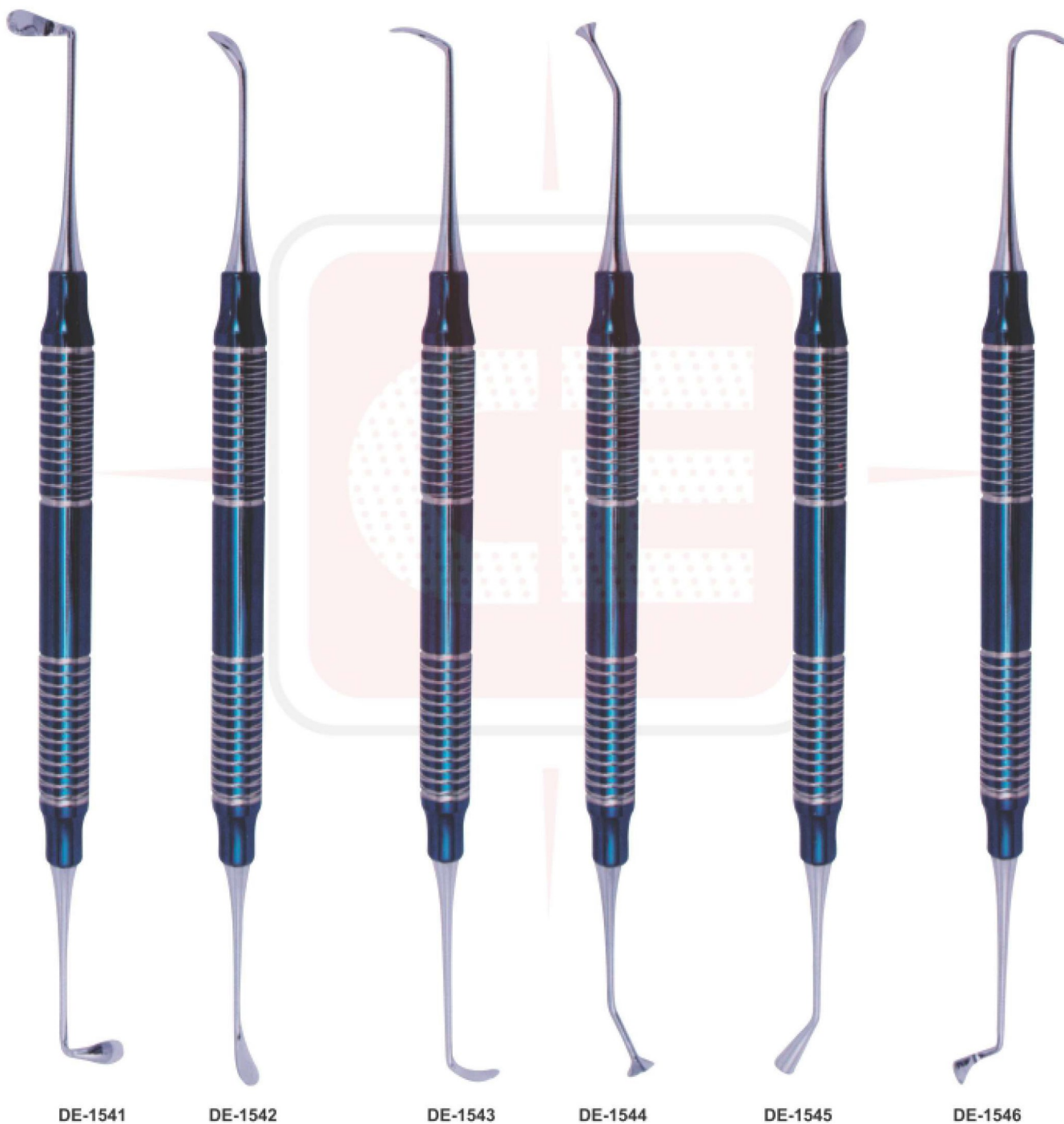

# IMPLANTOLOGY

- Инструменты для имплантологии
- Implantologie
- Implantologie

- Інструменти для імплантології
- Implantologia
- زراعة الأسنان

IMPLANT SINUS LIFT INSTRUMENTS  
PERIODONTAL SURGERY    SURGICAL CHISELS  
KRAMER NEVINS SINUS LIFT



DE-1547 TG



DE-1548 SOLT3/4



DE-1549 TGO



DE-1550 29K



DE-1551 FEDI4



DE-1552 OCH3



DE-1553 OCH4



DE-1554 FEDI1



DE-1555 FEDI2



DE-1556 FEDI3



DE-1557 Gf36

# IMPLANTOLOGY

- Инструменты для имплантологии
- Implantologie
- Implantologie

- Инструменти для імплантології
- Implantologia
- زراعة الأسنان

## IMPLANT

## SURGICAL CHISELS

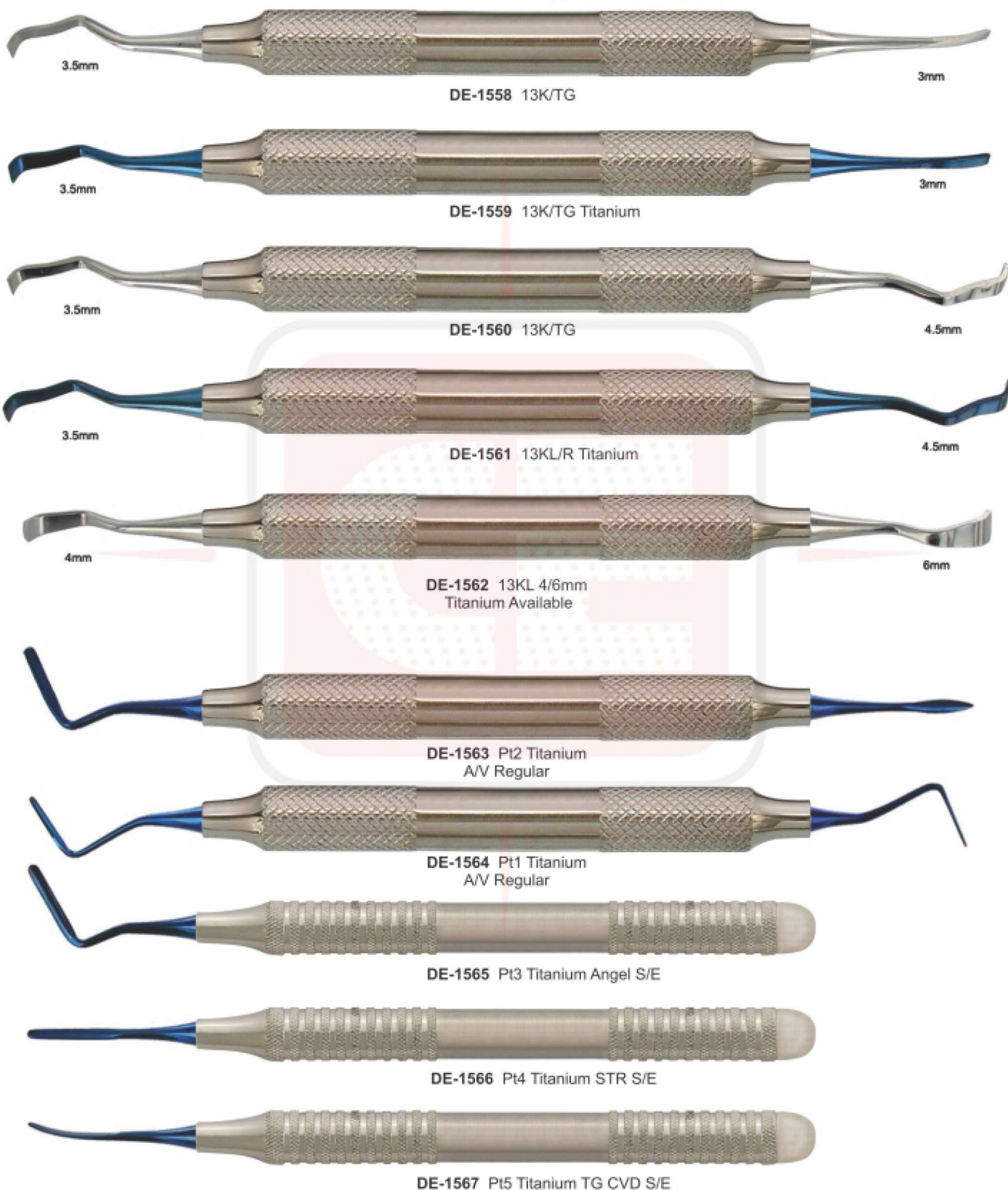

# IMPLANTOLOGY

- Инструменты для имплантологии
  - Implantologie
  - Implantologie
- Інструменти для імплантології
  - Implantologia
  - زراعة الأسنان

## MIXING SPATULA WITH SHOVEL



**DE-1568**  
Bone Carrier  
Titanium



**DE-1569**  
Raspator, Prichard  
Length 180 mm,  
10 mm hollow handle,  
double-ended  
10.5 mm | 4.5 mm,



**DE-1570**  
Raspator, Prichard  
Length 180 mm,  
10 mm hollow handle,  
double ended



**DE-1571**  
Raspator, Prichard  
Length 180 mm,  
10 mm hollow handle,  
double-ended  
10.5 mm | 4.5 mm,



**DE-1572**  
Mixing Spatula  
with shovel  
17cm



**DE-1573**  
Mixing Spatula  
with shovel  
18.5cm

# IMPLANTOLOGY

- Инструменты для имплантологии
- Implantologie
- Implantologie
- Инструменти для имплантології
- Implantologia
- زراعة الأسنان

## **BONE GRAFTING INSTRUMENTS COMPACTOR /TAMPERS**

Product offering includes instruments for harvesting, mixing and compacting bone Provides clinicians with the proper instrumentation for bone grafting procedures Weighted bone basin Prevents tipping and spilling of bone and other materials during mixing



**DE-1574**  
Graft Packer,  
Concave Tips  
DE 4/6mm

**DE-1575**  
Bone Spoon/  
Packer DE 3mm

**DE-1576**  
Graft Packer,  
Serrated Tips  
DE 6/8mm

**DE-1577**  
Graft Packer,  
Serrated Tips  
DE 3/4mm

**DE-1578**  
Graft Packer,  
Smooth Tips  
DE 5/8mm

**DE-1579**  
Titanium graft packer/  
placement site depth  
gauge 3.3mm & 4.0mm  
Diameter tips Marked  
at 8, 11, 13, 15 & 18mm

**DE-1580**  
Graft Material Spoon  
Concave Tip For  
Larger Grafts

# IMPLANTOLOGY

- Инструменты для имплантологии
- Implantologie
- Implantologie
- Инструменти для имплантології
- Implantologia
- زراعة الأسنان

## BONE GRAFTING INSTRUMENTS

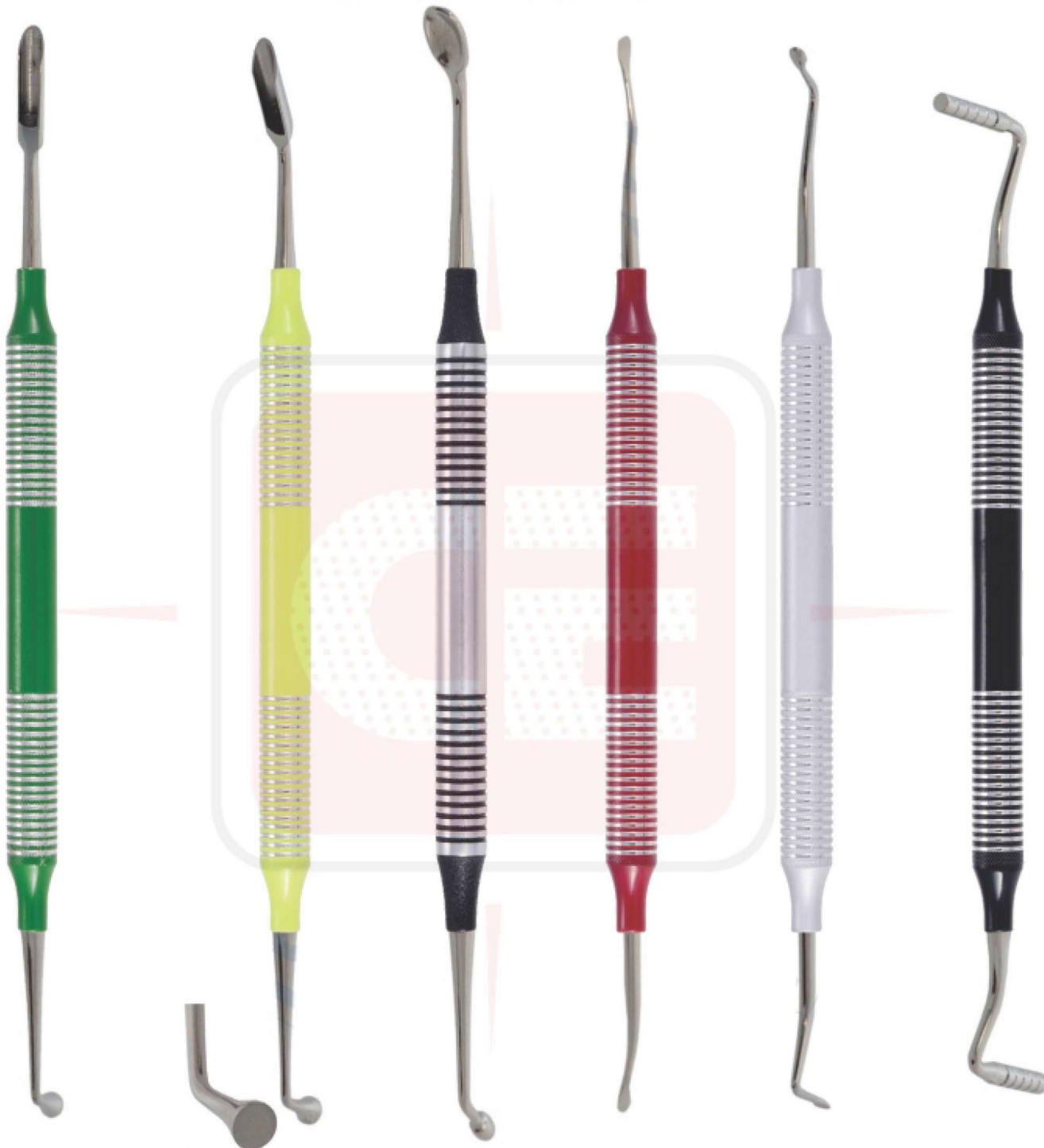

**DE-1581**  
**Blade and pusher**  
 Length 180 mm,  
 for straight or angled,  
 blade: 15 x 5 mm,  
 pusher: 4 mm diameter  
 Straight

**DE-1582**  
**Blade and pusher**  
 Length 180 mm,  
 for straight or angled,  
 blade: 15 x 5 mm,  
 pusher: 4 mm diameter  
 angular

**DE-1583**  
**Spoon and pusher**  
 Length 180 mm,  
 for angled spoon:  
 10 x 5 mm, pusher:  
 diameter 3 mm

**DE-1584**  
**Tunnelierungs  
 Instrument**  
 length 175 mm,

**DE-1585**  
**Tunnelierungs  
 Instrument**  
 length 175 mm,  
 different designs

**DE-1586**  
**Tamper**  
 Length 170 mm,  
 for bone material,  
 double-ended,  
 diameter 3.2 mm  
 (2-4-6-8-10) and diameter  
 2.5mm (2-4-6-8-10)

# IMPLANTOLOGY

- Инструменты для имплантологии
  - Implantologie
  - Implantologie
- Инструменти для імплантології
  - Implantologia
  - زراعة الأسنان

### Pluggers Clarizio

Length 160 mm, with titanium tips for mixing and pouring of autologous, heterologous bone substitute material, diameter (3/4 or 6/8 mm)

### BONE GRAFTING INSTRUMENTS



DE-1587 Ø 4mm  
DE-1588 Ø 5mm  
Compactor  
150mm



DE-1589  
Sinus Window  
Bone Tampers  
4 mm



DE-1590  
Sinus Window  
Bone Tampers  
7 mm



DE-1591  
6/8mm



DE-1592  
3/4mm

# IMPLANTOLOGY

- Инструменты для имплантологии
- Implantologie
- Implantologie
- Инструменти для імплантології
- Implantologia
- زراعة الأسنان

## SPOON AND PUSHER (TRINOVO)

Trinovo handle, different workers, for bone material, high-grade medical stainless steel, corrosion-resistant





# IMPLANTOLOGY

- Инструменты для имплантологии
- Implantologie
- Implantologie

- Инструменти для імплантології
- Implantologia
- زراعة الأسنان

## PERIOSTEALS ELEVATOR 10mm Hollow Handle

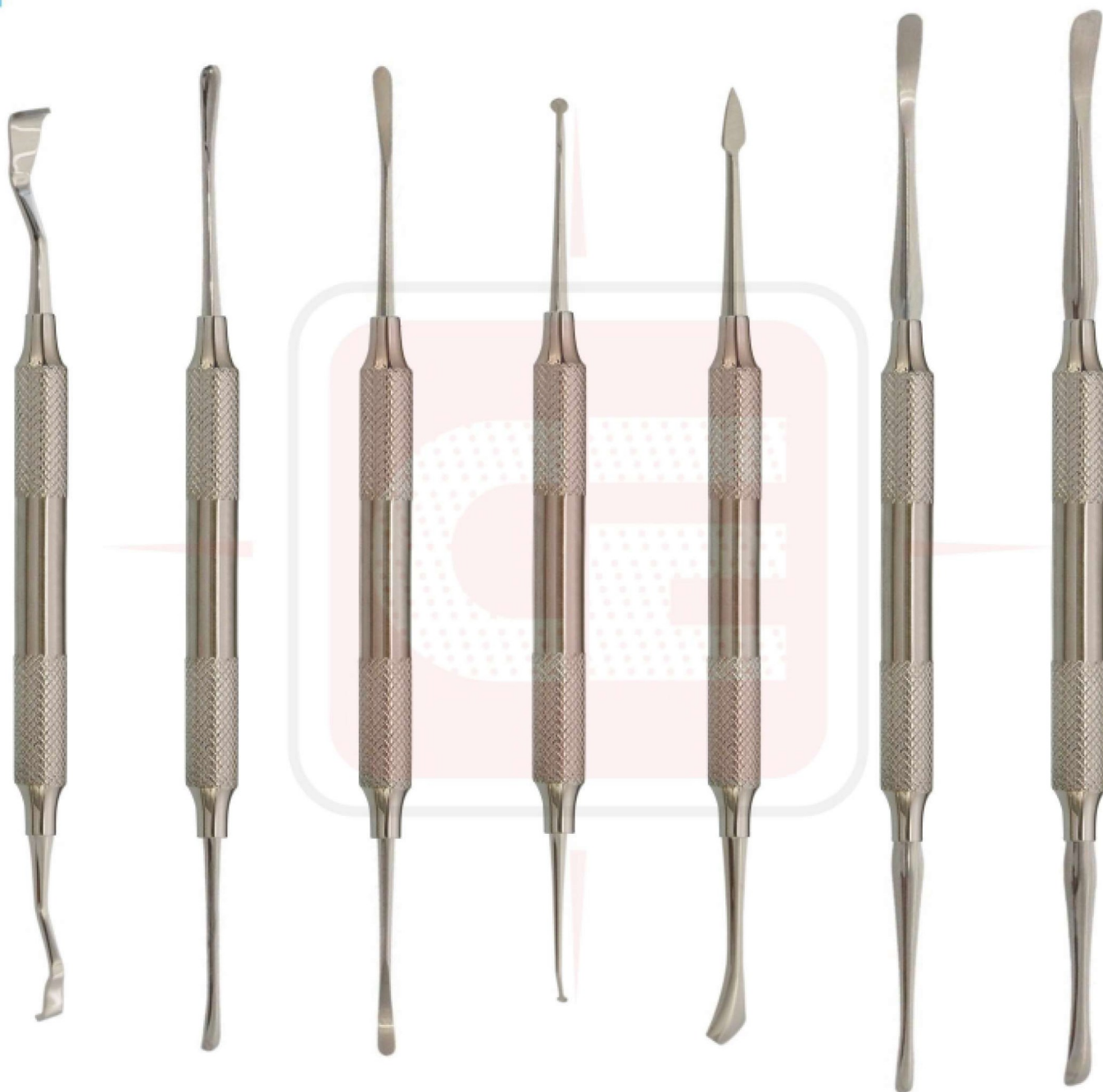

**DE-1600**  
Raspator,  
BonexScraper  
Length 165 mm,  
10 mm hollow  
handle,  
double-ended 6  
mm / 4 mm,

**DE-1601**  
Raspator,  
Raspatory  
Length 180 mm,  
10 mm hollow  
handle,  
double-ended  
3 mm | 3 mm,

**DE-1602**  
Raspator,  
Raspatory  
Length 180 mm,  
10 mm hollow  
handle,  
double-ended  
3 mm | 3 mm,

**DE-1603**  
Raspator,  
Papilla  
Length 185 mm,  
10 mm hollow  
handle,  
double-ended  
3 mm | 2 mm,

**DE-1604**  
Raspator,  
bone scraper  
Length 175 mm,  
10 mm hollow  
handle,  
double-ended,

**DE-1605**  
Raspator,  
micro-Freer  
Length 180 mm,  
6 mm solid grip,  
double-ended  
3 mm | 4 mm

**DE-1606**  
Raspator,  
Freer  
Length 180 mm,  
6 mm solid  
handle,  
double-ended  
5 mm | 5 mm,

# IMPLANTOLOGY

- Инструменты для имплантологии
- Implantologie
- Implantologie
- Инструменти для имплантології
- Implantologia
- زراعة الأسنان

## PERIOSTEALS ELEVATOR 10mm Hollow Handle



**DE-1607**  
Raspator,  
Freer  
10 mm hollow  
handle,  
high-quality  
medical  
double ended

**DE-1608**  
Raspator,  
Molt  
Length 180 mm,  
8 mm solid  
grip,  
double-ended  
6 mm

**DE-1609**  
Raspator,  
micro Freer  
Length 185 mm,  
10 mm hollow  
handle,  
double-ended,

**DE-1610**  
Raspator,  
micro Freer  
Length 185 mm,  
10 mm hollow  
handle,  
double-ended,

**DE-1611**  
Raspator, micro  
Raspator /  
chisel  
Length 170 mm,  
10 mm hollow  
handle,  
double-ended,

**DE-1612**  
Raspator, micro  
Raspator /  
chisel  
Length 175 mm,  
10 mm hollow  
handle,  
double-ended,

**DE-1613**  
Raspator,  
Micro Raspator /  
chisel  
Length 175 mm,  
8 mm solid handle,  
double-ended  
3.5mm | 3.5 mm,

# IMPLANTOLOGY

- Инструменты для имплантологии
- Implantologie
- Implantologie
- Инструменти для імплантології
- Implantologia
- زراعة الأسنان

## PERIOSTEALS ELEVATOR 10mm Hollow Handle



**DE-1614**  
Raspatory Micro Molt  
Length 175 mm,  
corrosion-resistant

**DE-1615**  
Raspatory Chipping  
Workers:  
Chisel 24G and 7.5 mm,  
length about 175 mm,  
corrosion-resistant

**DE-1616**  
Raspatory MOLT  
Work ends:  
5.0 mm and 4.0 mm,  
length about 175 mm,  
corrosion-resistant

**DE-1617**  
Rasp, Molt M9  
Length 175 mm,  
corrosion-resistant

**DE-1618**  
Raspator, WAUTIER  
Length 175 mm,  
corrosion-resistant

**DE-1619**  
Raspator, BENQUE  
Length 170 mm,  
workers  
5 mm | 7 mm,  
corrosion-resistant

**DE-1620**  
Raspator, Nordberg  
Length 180 mm,  
8 mm hollow handle  
double-ended  
6 mm | 4 mm

# IMPLANTOLOGY

- Инструменты для имплантологии
- Implantologie
- Implantologie

- Інструменти для імплантології
- Implantologia
- زراعة الأسنان

**Hollow Handle 10mm Length 170mm**

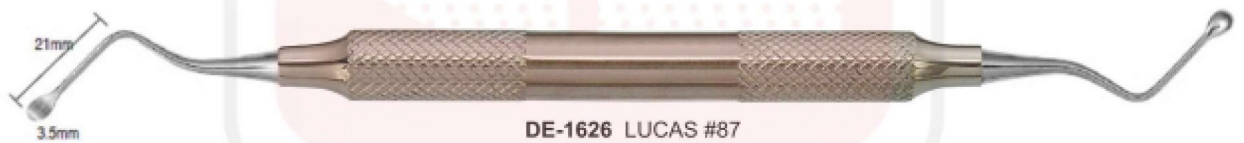
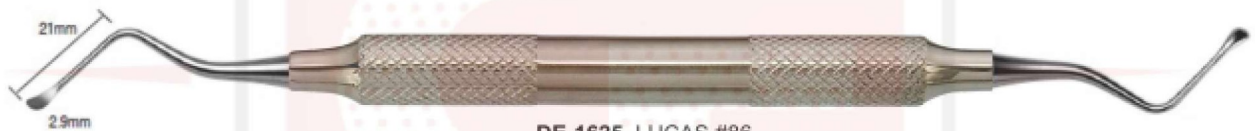
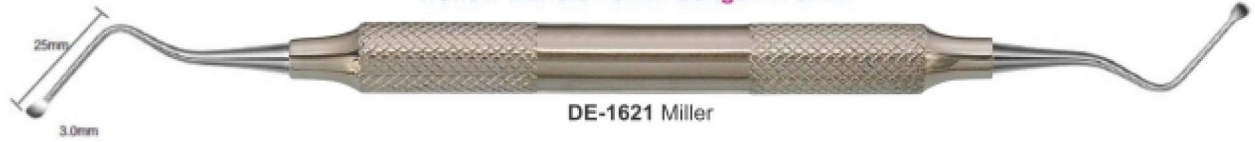

# IMPLANTOLOGY

- Инструменты для имплантологии
- Implantologie
- Implantologie

- Инструменти для імплантології
- Implantologia
- زراعة الأسنان

## TISSUE MEMBRANE FORCEPS



**DE-1630**  
Tissue Graft Forcep  
Serrated Teeth



**DE-1631**  
Self Locking  
Grooved



**DE-1632**  
Tissue Graft Forcep  
Serrated Teeth



**DE-1633**  
Titanium  
Locking Plier



**DE-1634**  
TC Gripper Carbide  
Tipped Tissue Forceps  
Serrated Carbide Tips  
14.5cm



**DE-1635**  
Adson Carbide  
Tipped Tissue Forceps  
Serrated Carbide Tips  
12cm



**DE-1636**  
Micor Adson 1x2  
Tissue Forcep 12.1cm  
1x2 Teeth - 0.5mm Tips



**DE-1637**  
Adson 7x7  
Tissue Forceps  
7x7 Teeth 12cm



**DE-1638**  
Adson 7x7 Curved  
Tissue Forceps  
7x7 Teeth 12cm



**DE-1639**  
Suture Pliers  
Suture Forceps with  
1.6mm Ring Tip



**DE-1640**  
Debakey Atraumatic  
Tissue Forceps Straight  
Serrated Teeth  
16cm



**DE-1641**  
Debakey Atraumatic  
Tissue Forceps Curved  
Serrated Teeth  
16cm

# IMPLANTOLOGY

- Инструменты для имплантологии
- Implantologie
- Implantologie
- Инструменти для імплантології
- Implantologia
- زراعة الأسنان

## TISSUE MEMBRANE FORCEPS



**DE-1642**  
Russian Long  
Tissue Forceps  
Serrated Tip  
20cm



**DE-1643**  
Russian  
Tissue Forceps  
Serrated Tip  
15cm



**DE-1644**  
Tissue Punch Forceps  
To Remove Tissue  
After Using Punch



**DE-1645**  
13.5 cm  
narrow



**DE-1646**  
10.5 cm



**DE-1647**  
13.5 cm  
wide

### Membrane tweezers KUEHNE



**DE-1648**  
Pin-Tweezers  
with or without lock,  
length 15 cm,  
with lock



**DE-1649**  
without lock,



**DE-1650**  
Haltepinzette with lock  
15,5 cm, for pins, towards  
the tips, etc.,



**DE-1651**  
Carry Forceps  
15cm



**DE-1652**  
Carry Forceps  
15cm



**DE-1653**  
Carry Forceps  
15cm

# IMPRESSION TRAY & HOLLOW WARE

- Инструменты для имплантологии
- Implantologie
- Implantologie
- Инструменти для имплантології
- Implantoloia
- زراعة الأسنان

## OSTEOTOME CONVEXES / CONCAVE / CONIQUES

CONVEXES



**DE-1654**  
SET OF 5 PIECES

CONCAVES

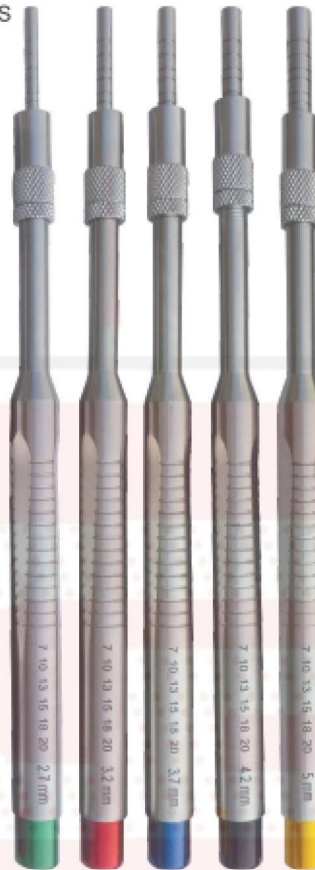





**DE-1655**  
SET OF 5 PIECES

CONIQUES

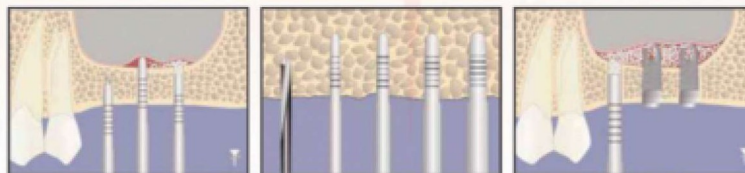

**DE-1656**  
SET OF 5 PIECES



	CONVEXES STRAIGHT	<b>DE-1654</b>	2,7 Ømm	3,2 Ømm	3,7 Ømm	4,2 Ømm	5 Ømm
	CONCAVES STRAIGHT	<b>DE-1655</b>	2,7 Ømm	3,2 Ømm	3,7 Ømm	4,2 Ømm	5 Ømm
	CONIQUES STRAIGHT	<b>DE-1656</b>	2,7 Ømm	3,2 Ømm	3,7 Ømm	4,2 Ømm	5 Ømm

# IMPLANTOLOGY

- Инструменты для имплантологии
- Implantologie
- Implantologie
- Инструменти для імплантології
- Implantologia
- زراعة الأسنان

## OSTEOTOME CONVEXES / CONCAVE / CONIQUES

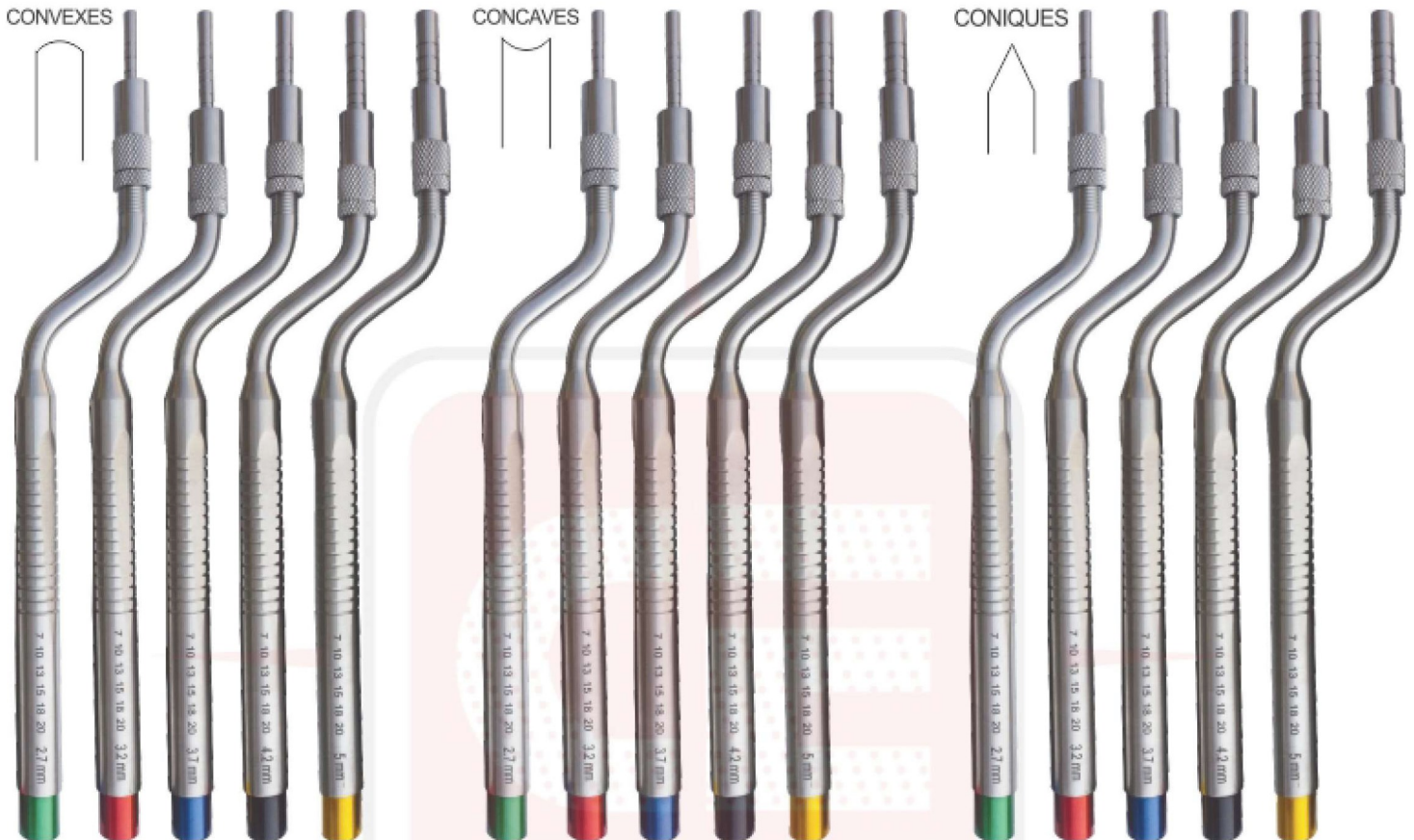



**DE-1657**  
**SET OF 5 PIECES**

**DE-1658**  
**SET OF 5 PIECES**

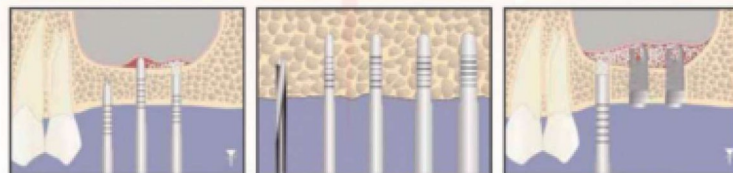
**DE-1659**  
**SET OF 5 PIECES**



	CONVEXES CURVED	DE-1657	2,7 Ømm	3,2 Ømm	3,7 Ømm	4,2 Ømm	5 Ømm
	CONCAVES CURVED	DE-1658	2,7 Ømm	3,2 Ømm	3,7 Ømm	4,2 Ømm	5 Ømm
	CONIQUES CURVED	DE-1659	2,7 Ømm	3,2 Ømm	3,7 Ømm	4,2 Ømm	5 Ømm



# IMPLANTOLOGY

- Инструменты для имплантологии
- Implantologie
- Implantologie

- Инструменти для імплантології
- Implantoloia
- زراعة الأسنان

## TREPINE

Burs with depth markings are suited for precise and simple transplantation of cylindrical bone grafts as well as for all other bone-extraction tasks.



**DE-1669**  
Tissue Punch with pin  
Set of Four Pieces



**DE-1670**  
Tissue Punch  
Set of Five Pieces

**DE-1671**  
Tissue Punch  
Set of Five Pieces



**DE-1672**  
Trephine Drill  
Set of Eight Pieces



**DE-1675**  
Trephine Drill  
Set of Eight Pieces



**DE-1673**  
Short Implant Drills

**DE-1674**  
Long Implant Drills

# IMPLANTOLOGY

- Инструменты для имплантологии
- Implantologie
- Implantologie
- Инструменти для імплантології
- Implantologia
- زراعة الأسنان

## BONE SCRAPER STRAIGHT & CURVED



**DE-1676**  
Bone Scraper  
Straight

**DE-1677**  
Bone Scraper  
Curved

## TISSUE PUNCH STRAIGHT & CURVED

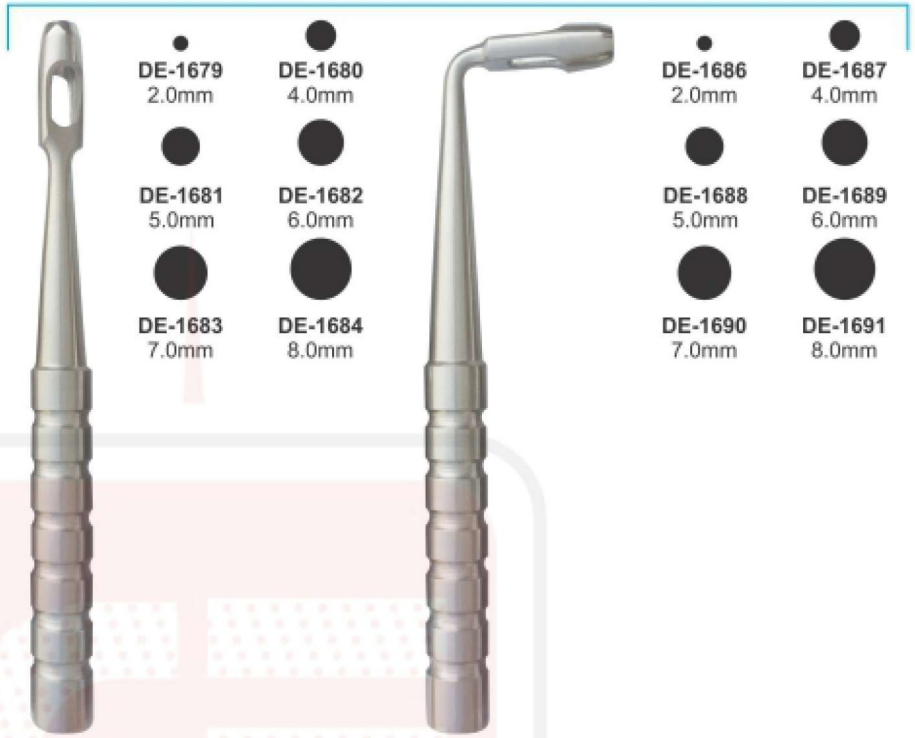

**DE-1678**  
Tissue Punch  
Straight

**DE-1685**  
Tissue Punch  
Curved



**DE-1692**  
Bone Mill



**DE-1693**  
Basins For Bone



**BONE CRUSHER**  
**DE-1694**

# IMPLANTOLOGY

- Инструменты для имплантологии
- Implantologie
- Implantologie
- Инструменти для імплантології
- Implantologia
- زراعة الأسنان

## KEYS FOR IMPLANT SCREW



DE-1695

DE-1696

DE-1697

DE-1698

## TORQUE WRENCH & RATCHET



DE-1699 Star Torque Wrench 6.35mm Universal



DE-1700 Round Torque Wrench 4.0mm Universal



DE-1701 Hex Driver With 4.0mm Driver



DE-1702 Star Torque Wrench 6.35mm Universal



DE-1703 Hex Torque Wrench 4.00mm Universal



DE-1704 Star Torque Wrench 6.35mm Universal



DE-1705 Star Torque Wrench 6.35mm Universal



DE-1706 Star Torque Wrench 6.35mm Universal



DE-1707 Star Torque Wrench 6.35mm Universal



DE-1708 Star Torque Wrench 6.35mm Universal



DE-1709 Star Ratchet Wrench 6.35mm Universal



DE-1710 Star Ratchet Wrench 6.35mm Universal



DE-1711 Star Ratchet Wrench 6.35mm Universal



DE-1712 Star Ratchet Wrench 4.0mm Universal



DE-1713 Round Ratchet Wrench 4.0mm Universal



DE-1714 Round Ratchet Wrench 3.35mm Universal



DE-1715 Star Ratchet Wrench 4.0mm Universal



DE-1716 Star Ratchet Wrench 6.35mm Universal

# IMPLANTOLOGY

- Инструменты для имплантологии
  - Implantologie
  - Implantologie
- Інструменти для імплантології
  - Implantologia
  - زراعة الأسنان

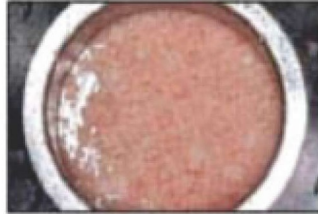

**DE-1719  
BONE CRUSHER**



**DE-1717  
BONE CRUSHER  
Titanium Metal Cutter**

mallet



**DE-1720  
BONE CRUSHER  
Bone Grinding Grain  
1.5mm, 2mm, 2.5mm**



**DE-1718  
BONE CRUSHER  
Titanium Metal Cutter**

mallet



**DE-1721  
BONE CRUSHER  
Bone Grinding Grain  
1.5mm, 2mm, 2.5mm**

# IMPLANTOLOGY

- Инструменты для имплантологии
- Implantologie
- Implantologie
- Инструменти для імплантології
- Implantologia
- زراعة الأسنان

## BONE EXPANDER SCREW & SURGICAL KITS



**DE-1722**  
 Bone Universal Kit  
 Drill: 2mm, 2.8mm, 3.2mm, 3.65mm, 4.2mm, 4.5mm, 4.8mm, 5.2mm  
 Trephines Bit:  
 3.0mm, 4.0mm, 5.0mm, 6.0mm, 7.0mm, 8.0mm, 9.0mm, 10mm.  
 Driver:  
 2.5mm, 2.5mm Hand Pcs  
 1.25mm, 1.25mm Hand Pcs  
 Short Driver 2.5mm  
 Long Driver 2.5mm  
 1.25mm, Short Hex Driver Hand Pcs  
 1.25mm, Long Hex Driver Hand Pcs  
 Torque Wrench 4.0mm



**DE-1723**  
 Bone Expander Kit  
 Expander: 2.6mm, 3.0mm, 3.4mm, 3.8mm, 4.3mm  
 Ratchet Driver  
 Parallel Pin  
 Pilot Drill  
 Drill 1.4mm  
 Drill Driver 4mm  
 Hand Driver 4mm  
 Ratchet 4.0mm



**DE-1724**  
 Bone Universal Kit  
 Drill: 2mm, 2.8mm, 3.2mm, 3.65mm, 4.2mm, 4.5mm, 4.8mm, 5.2mm  
 Trephines Bit:  
 3.0mm, 4.0mm, 5.0mm, 6.0mm, 7.0mm, 8.0mm, 9.0mm, 10mm.

Bone Compression:  
 2mm, 3.3mm, 2.8mm, 4.2mm, 3mm, 3.5mm  
 Driver:  
 2.5mm, 2.5mm Hand Pcs  
 1.25mm, 1.25mm Hand Pcs  
 Short Driver 2.5mm  
 Long Driver 2.5mm  
 1.25mm, Short Hex Driver Hand Pcs  
 1.25mm, Long Hex Driver Hand Pcs  
 Torque Wrench 6.35mm 1 Pcs



**DE-1725**  
 Conical Drills: 20 Pcs  
 Tissue Punches:  
 3.0mm, 3.50mm, 4.0mm, 4.5mm, 5.0mm, 6.0mm, 6.50mm  
 Bone Expander:  
 1.6/3.8mm, 1.9/3.0mm, 2.1/3.6mm, 2.6/3.8mm, 2.9/4.3mm  
 Drill Adapter: 1 Pcs  
 1.25mm, 2.50mm Hex Driver Hand Pcs

Pilot Drill: 1.6mm  
 Drill Bit: 1.4mm, 1.6mm, 1.8mm, 2.0mm, 2.2mm  
 Ratchet Driver: 4mm/6.35, 1.25/2.50  
 Rimer: 3.2/4.7mm, 3.7/4.7mm  
 Parallel Pin: 4.5mm, 2.5mm  
 Double step Drill: 2.4/2.8mm  
 Depth Gauge: 1 Pcs  
 Torque Wrench 6.35mm Universal: 1 Pcs

# IMPLANTOLOGY

- Инструменты для имплантологии
- Инструменти для імплантології
- Implantologie
- Implantologia
- Implantologie
- زراعة الأسنان

## BONE INJECTORS, COLLECTORS & SUCTION TUBE

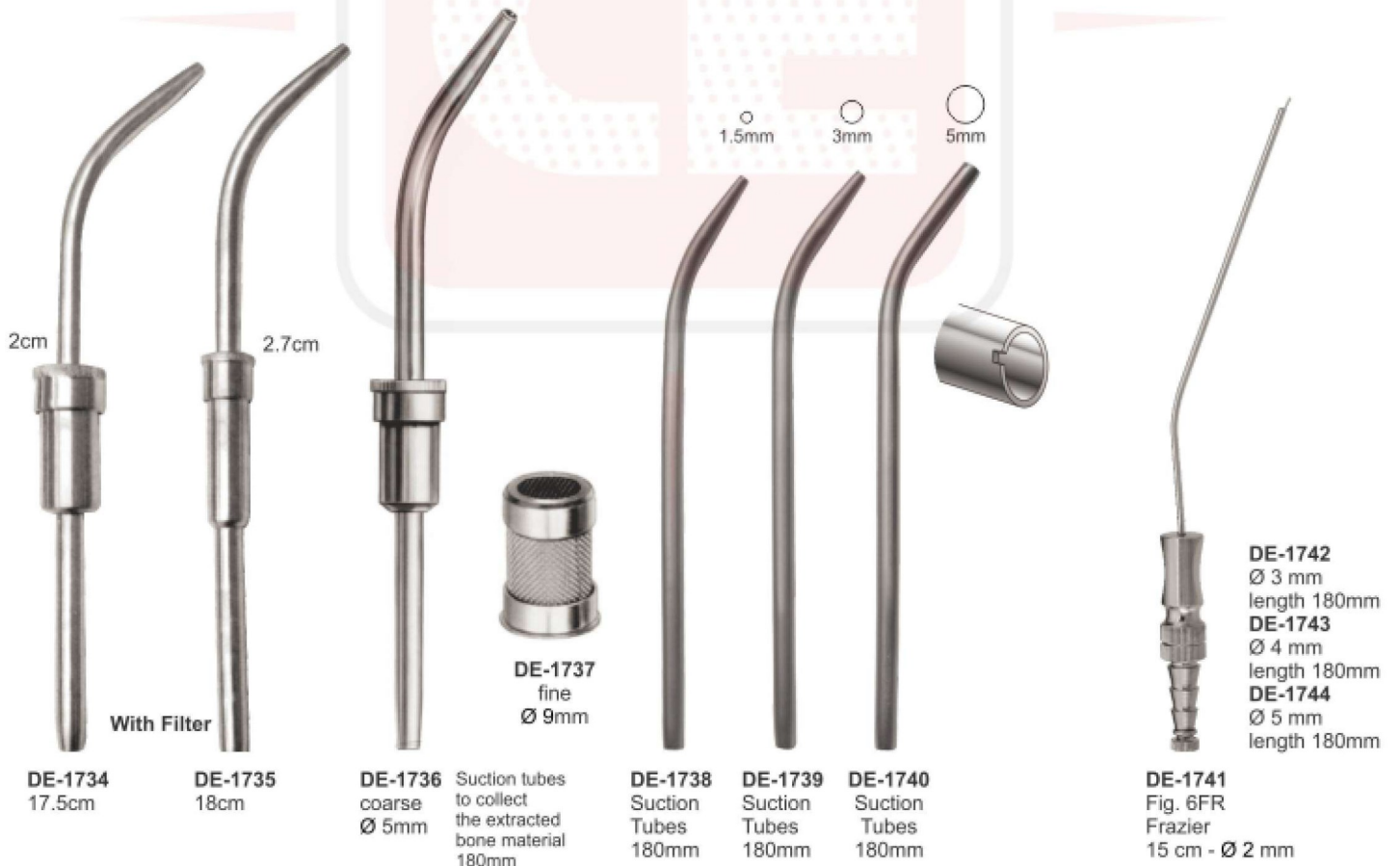
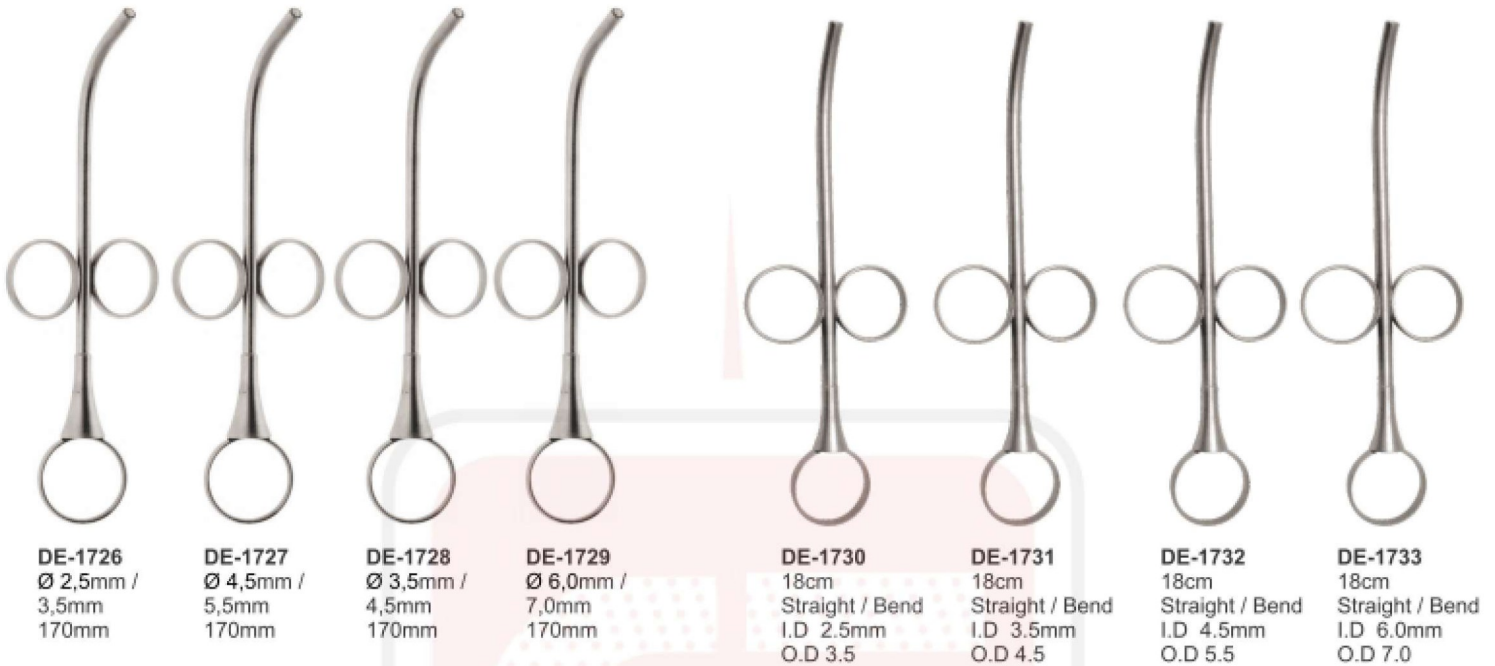

# IMPRESSION TRAYS

- Оттисковые ложки
- Porte-empreinte
- Abdrucklöffel
- Відбиткові ложки
- Cubetas para impresiones
- صواني الانطباع

## PERFORATED WITH RIM LOCK

Set of 06 Pcs

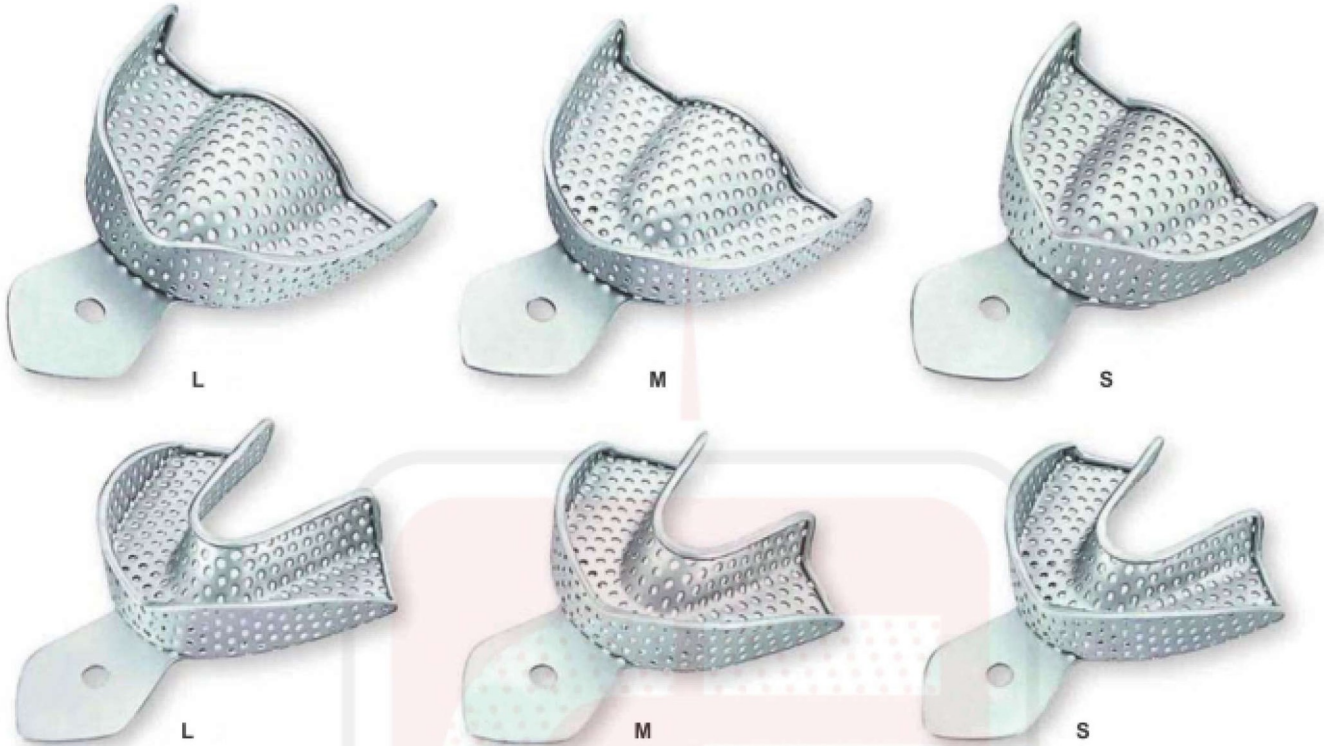

### DE-1745 SET OF 06 PCS

Upper: S, M, L  
Lower: S, M, L

## PERFORATED WITH RIM LOCK

Set of 8 Pcs



### DE-1746 SET OF 08 PCS

Upper: XS, S, M, L  
Lower: XS, S, M, L

### DE-1747 SET OF 08 PCS

Upper: S, M, L, XL  
Lower: S, M, L, XL

### DE-1748 SET OF 10 PCS

Upper: XS, S, M, L, XL  
Lower: XS, S, M, L, XL

# IMPRESSION TRAYS

- Оттисковые ложки
- Porte-empreinte
- Abdrucklöffel
- Відбиткові ложки
- Cubetas para impresiones
- صواني الانطباع

**SOLID WITH RIM LOCK**  
Set of 6 Pcs

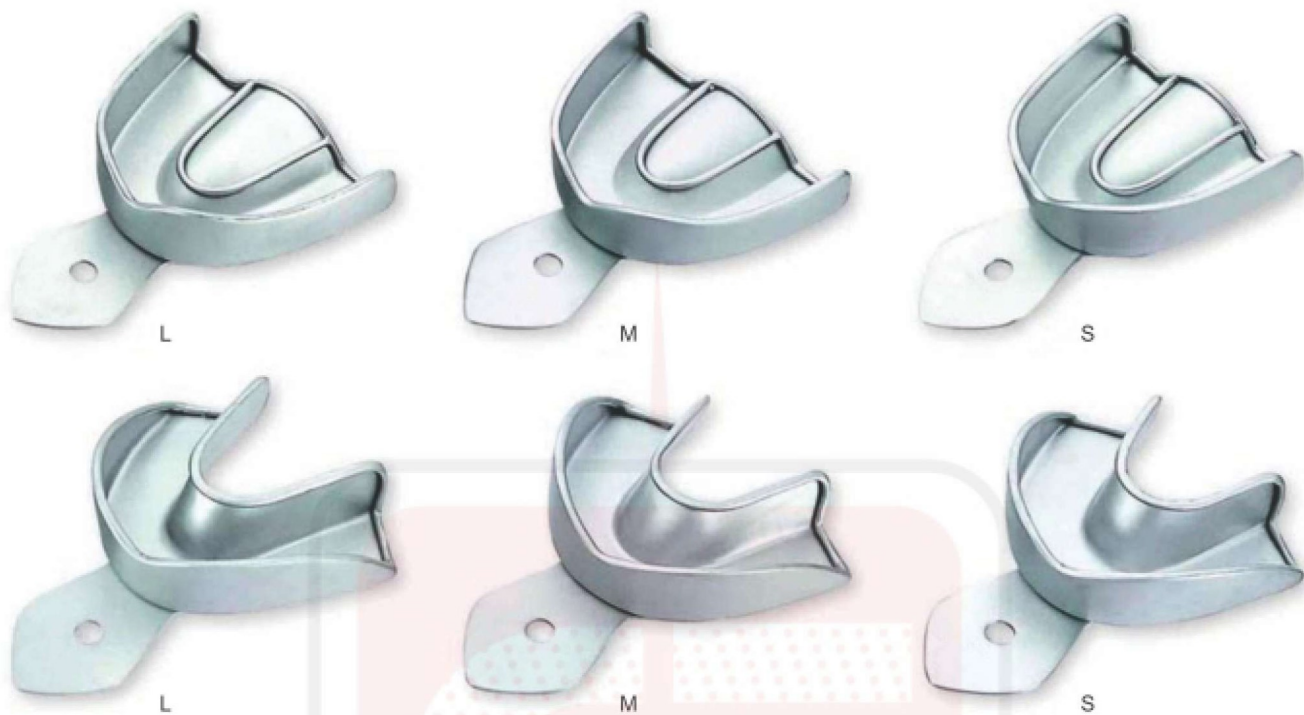

**DE-1749 SET OF 06 PCS**  
Upper: S, M, L  
Lower: S, M, L

**SOLID WITH RIM LOCK**  
Set of 8 Pcs

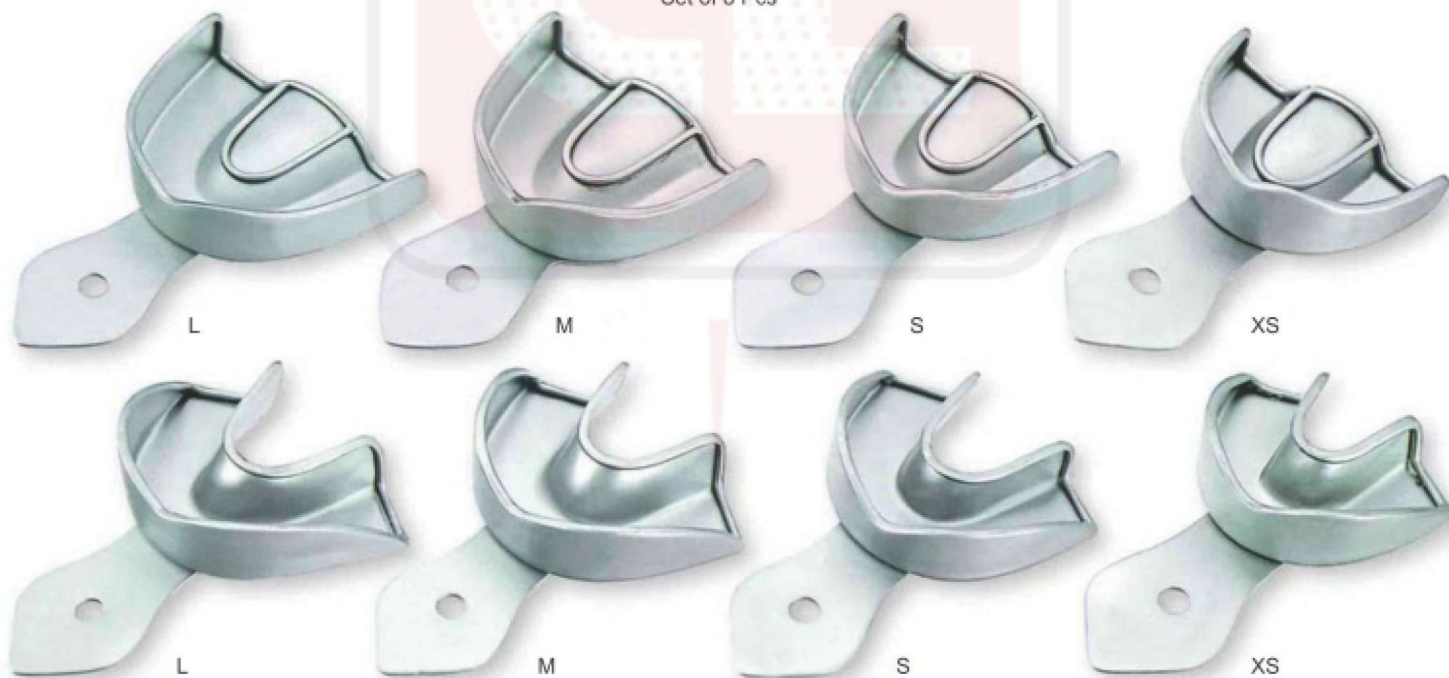

**DE-1750 SET OF 08 PCS**  
Upper: XS, S, M, L  
Lower: XS, S, M, L

**DE-1751 SET OF 08 PCS**  
Upper: S, M, L, XL  
Lower: S, M, L, XL

**DE-1752 SET OF 10 PCS**  
Upper: XS, S, M, L, XL  
Lower: XS, S, M, L, XL



# IMPLANTOLOGY

- Оттисные ложки
- Відбиткові ложки
- Porte-empreinte
- Cubetas para impresiones
- Abdrucklöffel
- صوتاتي الانطباع

## PERFORATED FULL DENTURE

Set of 8 Pcs

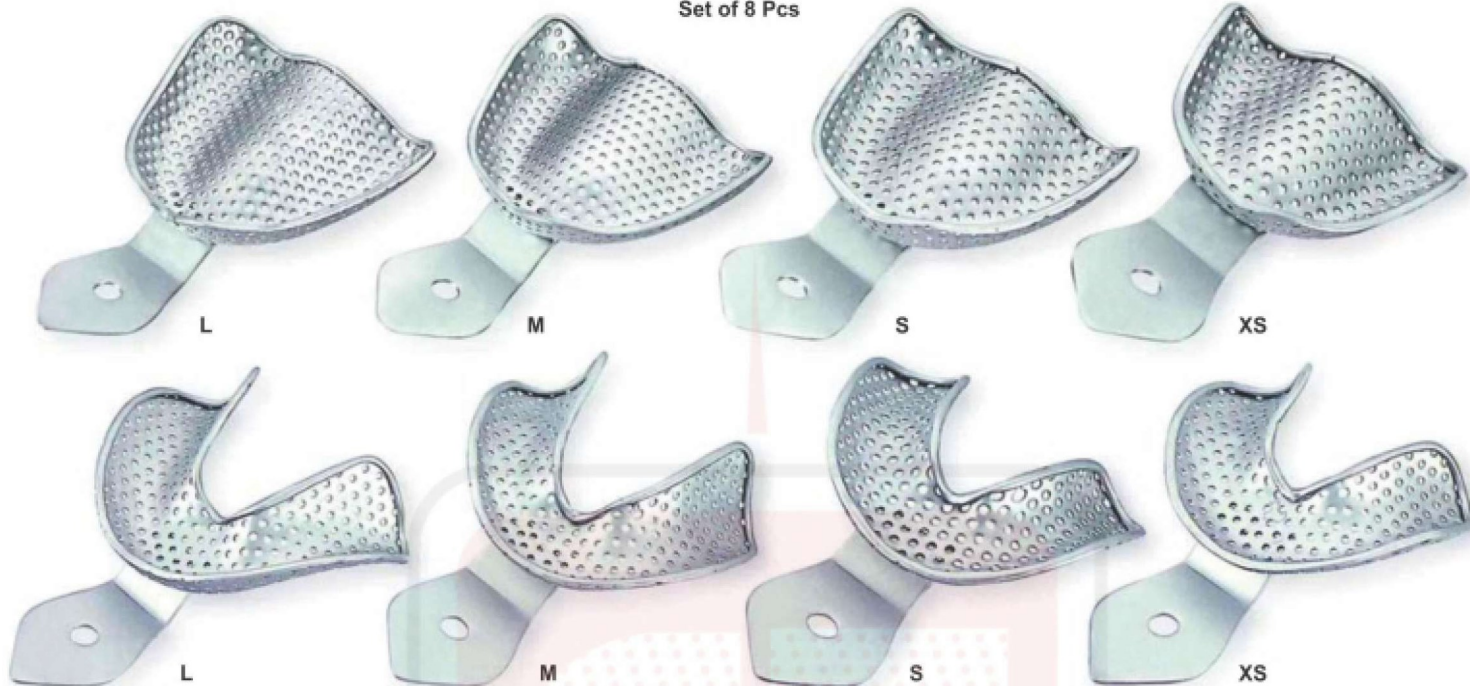

## SOLID FULL DENTURE

Set of 8 Pcs



# IMPRESSION TRAYS

- Оттисковые ложки
- Porte-empreinte
- Abdrucklöffel

- Відбиткові ложки
- Cubetas para impresiones
- صواني الإطباع

## Perforated Without Rim Lock

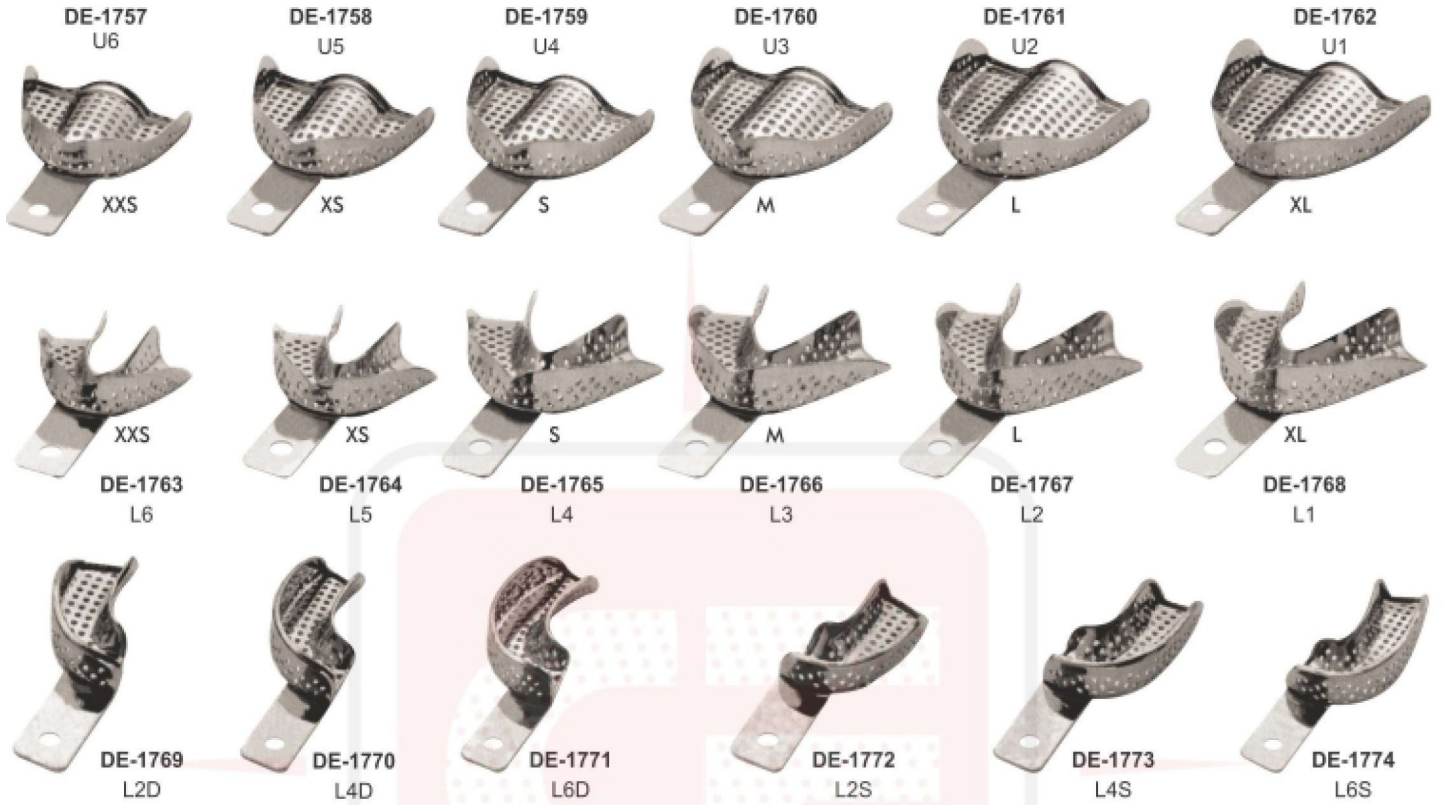

## Solid With Rim Lock

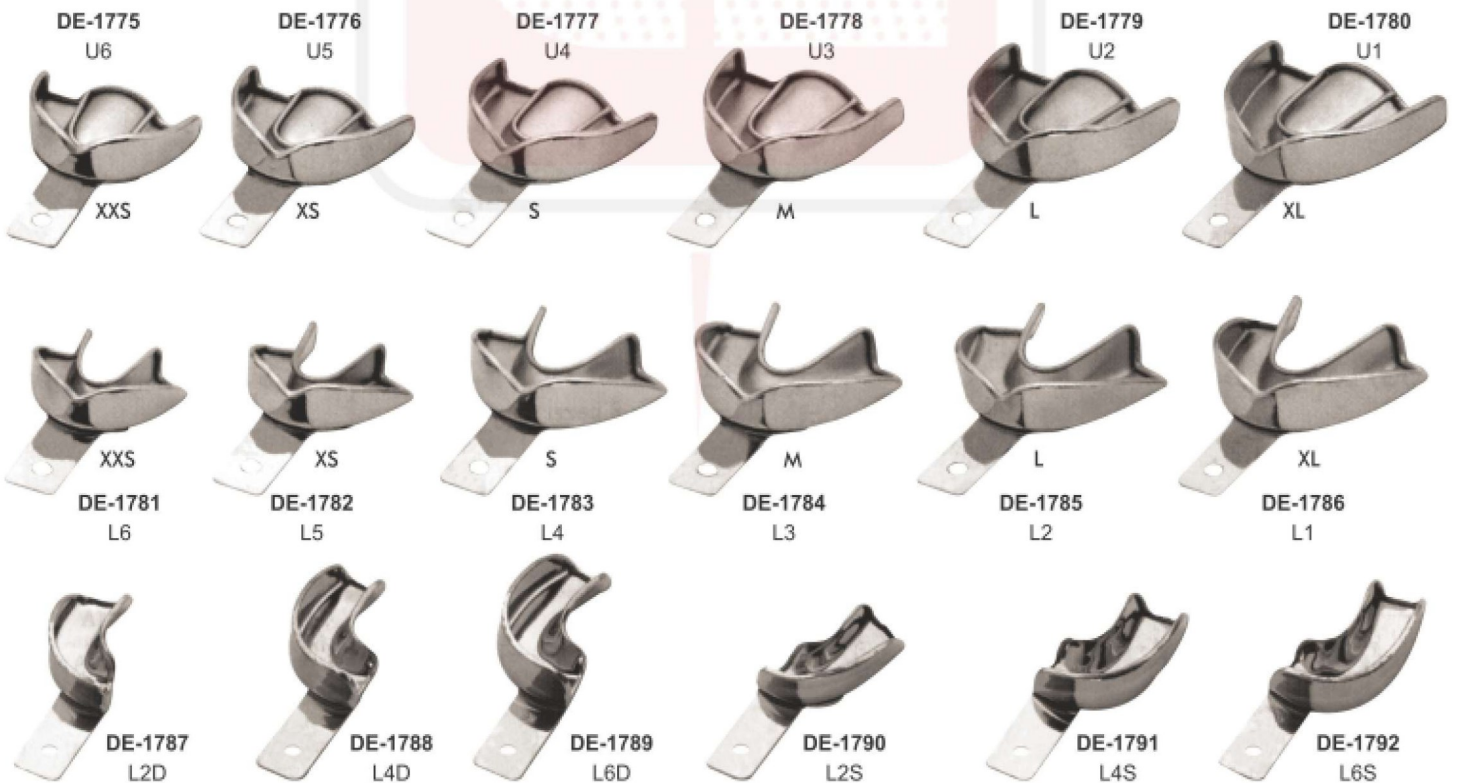

# INSTRUMENTS CASSETTES AND STANDS

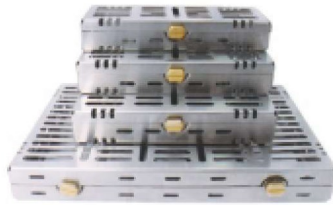

**DE-1793**  
Instruments Cassettes  
5 Pieces, 7 Pieces, 10 Pieces & 20 Pieces

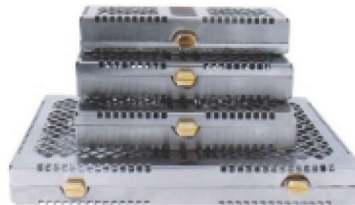

**DE-1794**  
Instruments Cassettes  
5 Pieces, 7 Pieces, 10 Pieces & 20 Pieces

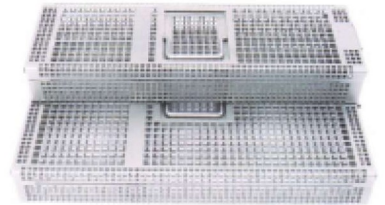

**DE-1795**  
Instruments Cassette  
7 Pieces & 10 Pieces



**DE-1796**  
Gracey Curette Set Cassettes

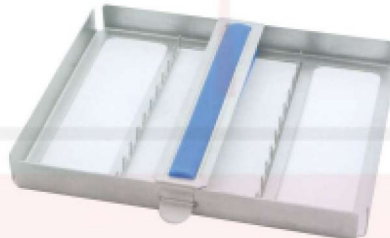

**DE-1797**  
182 x 150 x 20 mm  
10 Instruments



**DE-1798**  
180 x 85 x 15 mm  
5 Instruments



**DE-1799**  
288 x 182 x 35 mm  
20 Instruments

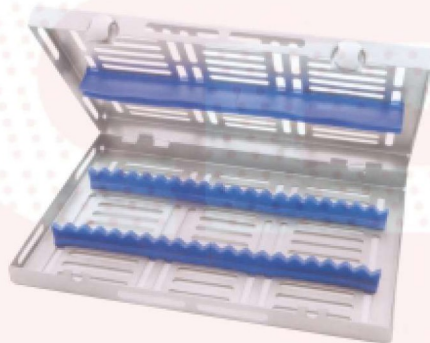

**DE-1800**  
288 x 182 x 35 mm  
20 Instruments



**DE-1801**  
182 x 145 x 35 mm  
10 Instruments

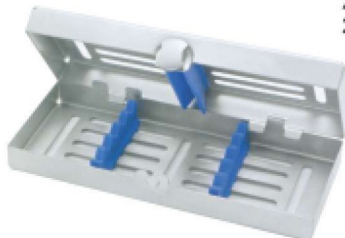

**DE-1802**  
182 x 72 x 35 mm  
5 Instruments



**DE-1803**  
182 x 145 x 35 mm  
9 Instruments

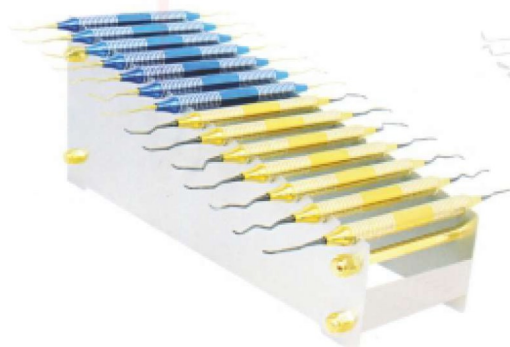

**DE-1804**  
Gracey Curette Set Stand

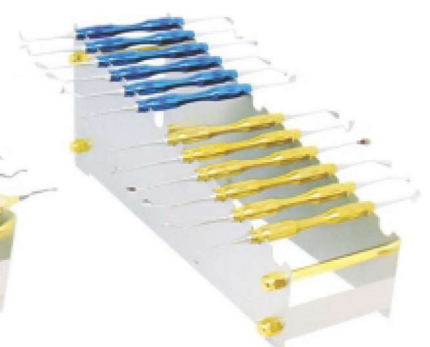

**DE-1805**  
Sinus Lift Set Stand

# HOLLOW WARE

Made of 18/8 stainless steel



**KIDNEY TRAY WITH COVER**  
(English Pattern)

	Size
DE-1806	150 mm
DE-1807	200 mm
DE-1808	240 mm
DE-1809	300 mm



**Kidney Trays**

With lid available	Without lid available
DE-1810 6"	DE-1814 6"
DE-1811 8"	DE-1815 8"
DE-1812 10"	DE-1816 10"
DE-1813 12"	DE-1817 12"



Deep	
DE-1818	2.25" - 2"
DE-1819	4.75" - 2"
DE-1820	5.5" - 2.5"
DE-1821	6.25" - 2.75"
DE-1822	7" - 3.5"



**Sterilizing Drum**

Art #	Ø mm	h mm
DE-1823	80	80
DE-1824	120	120
DE-1825	160	120
DE-1826	190	140
DE-1827	190	200
DE-1828	240	120
DE-1829	240	160
DE-1830	240	240
DE-1831	290	120
DE-1832	290	160
DE-1833	290	240
DE-1834	340	160
DE-1835	340	240
DE-1836	390	145
DE-1837	390	200
DE-1838	390	290



**Cotton Holder - DE-1839**



**Spirit Lamp DE-1840**



**DE-1841 Endodontic Box**



Forcep Jar	
DE-1842	25 x 80mm
DE-1843	30 x 100mm
DE-1844	100 x 200mm
DE-1845	75 x 173mm



DE-1846 6" x 8"  
DE-1847 8" x 10"  
DE-1848 10" x 12"  
Without Lid



**DE-1849 Instruments Box**



**SCALER TRAY DE-1850**  
100 x 200 mm



## DEMAANZ INDUSTRIES

Roras road,  
Sialkot, Pakistan.

Phone: +92-300 612 6898

Fax: +92-523-55 8686

Email: [info@demaanz.com](mailto:info@demaanz.com)



### Organization

**HEAD OFFICE**  
Shad Colony, Roras Road,  
Sialkot 51310 - Pakistan

Cell: +92-300-6126898  
Ph: +92-52-3558636  
Fax: +92-52-3558636

[info@demaanz.com](mailto:info@demaanz.com)  
[www.demaanz.com](http://www.demaanz.com)

