

ORTHOPADIC INSTRUMENTS CATALOG



HEAD OFFICE
Shad Colony, Roras Road,
Sialkot 51310 - Pakistan

Cell: +92-300-6126898
Ph: +92-52-3558636
Fax: +92-52-3558636

info@demaanz.com
www.demaanz.com



Welcome to **DeMaanz Industries**, a leading manufacturing & exporting company dealing in Medical Instruments such as Orthopedic Instruments, Dental Instruments & Neuro instruments.

The company was established in year 2000 and since the inception of the company, quality of work, retention of customer satisfaction, skilled craftsmanship in all our products and contemporary innovation have led our company achieve a benchmark in our product's quality and making difference towards our services at the same time.

The company enjoys a strong reputation in manufacturing premium quality products meeting all international standards. Besides this, we also adhere with prescribed rules for Child Labor following ILO rules, monitoring and implementing Health & Safety regulations, Environmental issues and complying with social compliance responsibility.

All our skilled force is backed by our research and development department that always looks through the innovative ideas, researching on improving quality standards and certain measurements to finally produce products at optimum quality.

In the end, I reiterate my words ensuring all our existing and potential buyers for providing them best possible service, in time deliveries, and product quotes meeting their budget lines and at the same time enjoying an opportunity towards best deals of premium quality products.

I warmly welcome all incoming inquiries concerning our products, quality standards or competitive quotes.

Regards,
Muhammad Suleman
Chief Executive

Mob: +92-300-612 6898

Land: +92-52-355 8686



BASIC ORTHOPEDIC INSTRUMENTS / SPAINAL INSTRUMENTS/ TRAUMA INSTRUMENTS



BASIC ORTHOPEDIC INSTRUMENTS / SPAINAL INSTRUMENTS/ TRAUMA INSTRUMENTS

<u>PARTICLARS</u>	<u>PAGE</u>
1- ORTHOPEDIC DRESSING –PLASTER INSTRUMENTS	01-03
2- AMPUTATION SAW-GIGLI SAW	04-05
3- REMERS-AWLS-BONE HOOKS	06-07
4- ORTHPEDIC HAND DRILLS & ACCESSORIES	08-11
5- BONE HOLDING CLAMPS –TRACTION BARS	12-13
6- VISE GRIPS– NOVE PLIERS– SLAP HAMMERS	14-15
7- NOSE PLIERS—PULLING FORCEPS– WIRE CUTTERS	16-18
8- PLIERS– BANDERS– ROD INSTRUMENTS	19-20
9- WIRE INSTRUMENTS– EXTANSION BOWS	21-23
10- RING CUTTERS– LEAD HANDS– BIPOSY TOOLS	24-25
11- BONE TEMPERS—IMPACTORS– PACKERS	26
12- BONE RASPS– FILES	27-30
13- BONE LEVERS– RETRACTORS	31-37
14- CHISELS– OSTEOTOMES– GOUGES	38-43
15- BONE CURETTES	44-49
16- PERIOSTEAL ELEVATORS– DISSECTORS	50-54
17- ORTHOPEDIC MALLETS & ELEVATORS SPINAL S/S SPINAL	55-58
18- TENDON INSTRUMENTS	59-62
19- PELVIC REDUCTION FORCEPS	63-64
20- BONE HOLDING FORCEPS	65-72
21- REPOSITION– CRATILAGE FORCEPS	73
22- BONE CUTTING FORCEPS	74-77
23- BONE RONGEURS– NIBBLERS	78-88
24- RIB SHEARS	89-90
25- LAMINA SPREADERS– RETRACTORS	91-92
26- CALCANEAL LAMBARDI SPREADERS	93
27- COMPRESSORS– DISTRATORS	94-95
28- ROD BENDERS	96
29- CARBIDE WIRE– PIN CUTTING PLIERS	97-100
30- CARBIDE INSERTED SURGICAL SCISSORS	101-102
31- INSTRUMENTS FOR TRUATOMY	103-115

WWW.DEMAANZ.COM

ORTHOPEDIC DRESSING - PLASTER INSTRUMENTS

DMI-1981-001

Lorenz Bandage Scissors
Heavy Pattern 23 cm / 9"

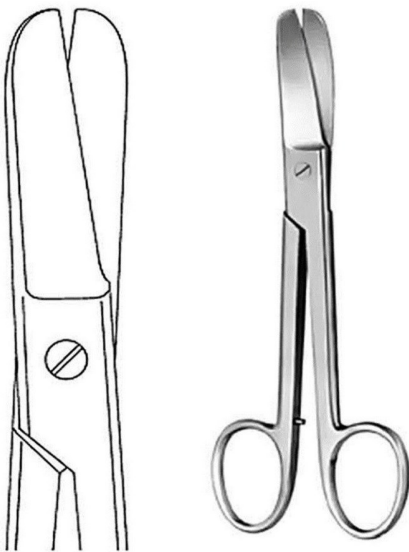

DMI-1981-002

Lister Bandage Scissors
14.5 cm / 5 ¾"

Also available
in 18.5 cm / 7 ¼"
& 20 cm / 8"

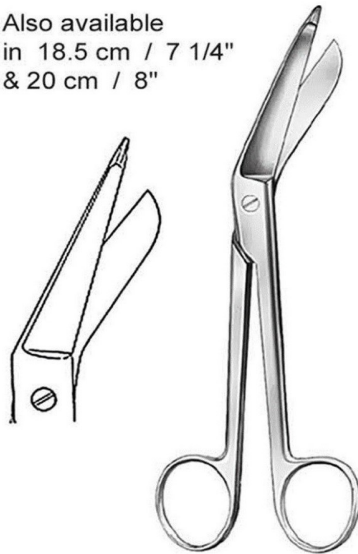

DMI-1981-003

Bergmann Plaster Shears
Heavy Pattern 23.5 cm / 9"

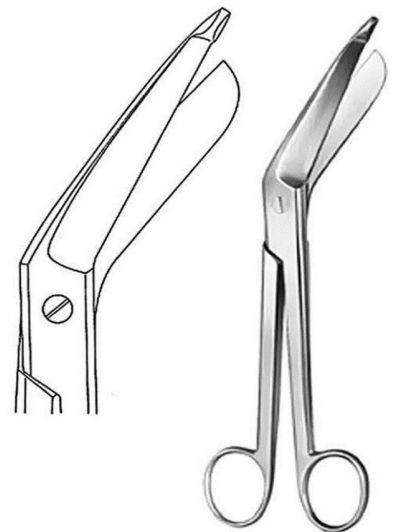

DMI-1981-004

Esmarch Plaster Shears
Heavy Pattern, Short Blades
20 cm / 8"



DMI-1981-005

Bandage Scissors
16cm / 6 ¼" Black Plastic Rings

Also available
in 18cm / 7 ½"



DMI-1981-006

Bruns Plaster Scissors 24 cm
9 ½" One Serrated Cutting Edge

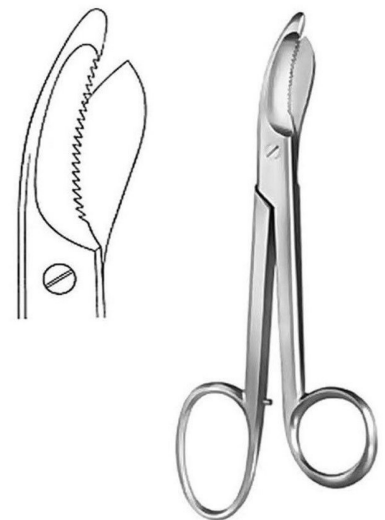

ORTHOPEDIC DRESSING - PLASTER INSTRUMENTS

DMI-1981-007

Stille-Martin Plaster Shears
23 cm / 9"



Also Available
26 cm / 10"
38 cm / 15"

DMI-1981-008

Engel Plaster Saw 15.5 cm / 6"



DMI-1981-009

Engel Plaster Saw 15.5 cm / 6"



DMI-1981-010

Bergmann Plaster Saw 18 cm / 7"



DMI-1981-011

Reiner Plaster Knife 18 cm / 7"



DMI-1981-012

Hopkins Plaster Knife 20 cm / 8"



DMI-1981-013

Esmarch Plaster Knife 18 cm / 7"



with wooden handle

DMI-1981-014

Martin Plaster Knife 21 cm / 8 ¼"

ORTHOPEDIC DRESSING - PLASTER INSTRUMENTS

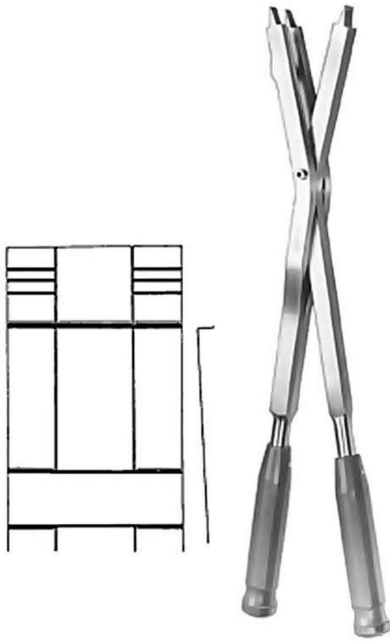

DMI-1981-015

Hermann Plaster Spreader
48 cm / 19" Heavy Pattern

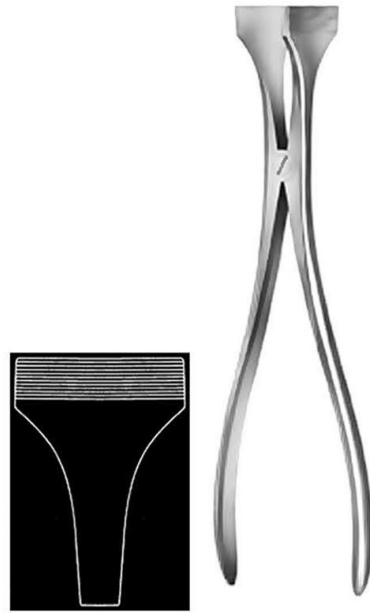

DMI-1981-016

Hennig Plaster Spreader
28 cm / 11"



DMI-1981-017

Hennig Plaster Spreader
30 cm / 12"



DMI-1981-018

Beeson Plaster Spreader 1.5 in Blade 30 cm / 12"

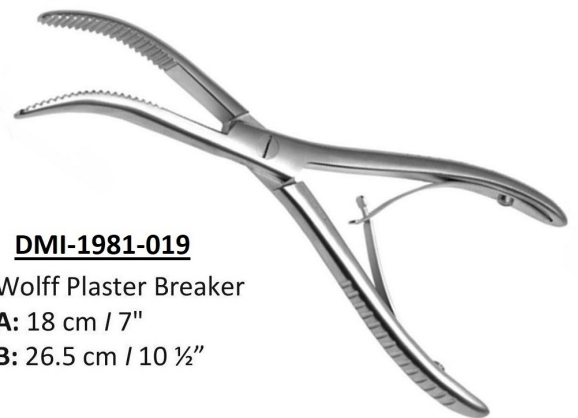

DMI-1981-019

Wolff Plaster Breaker
A: 18 cm / 7"
B: 26.5 cm / 10 1/2"



DMI-1981-020

Walton Plaster Spreader w/Spring 3 Prongs 23 cm / 9"

AMPUTATION SAW - GIGLI SAW

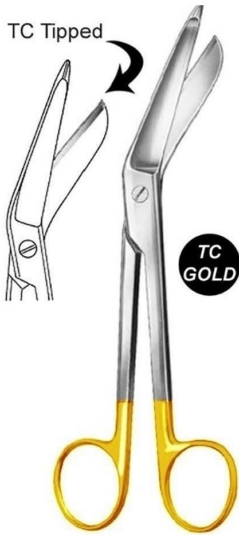

DMI-1981-021

Lister Bandage Scissors TC
18 cm / 7" cm / 13 3/4"



DMI-1981-022

Bruns Plaster Scissors
24 cm / 9 1/2"



DMI-1981-023

Charriere Amputation Saw 35 cm / 13 3/4"



A: 21.5 cm / 8 3/4" 12mm



B: 21.5 cm / 8 3/4" 15mm



C: 21.5 cm / 8 3/4" 18mm

Spare Saw Blades

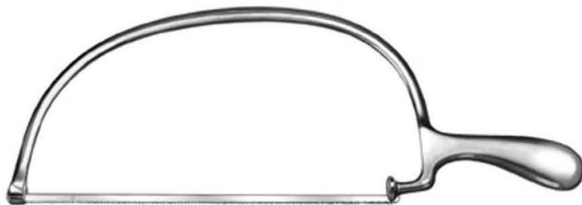

DMI-1981-024

BIER Amputation Saw 40.5 cm / 16"



A: 27 cm / 10 3/4" 4 mm wide



B: 27 cm / 10 3/4" 6 mm wide



C: 27 cm / 10 3/4" 8 mm wide



DMI-1981-025

Langenbeck Amputation Saw 24.5 cm / 9 3/4"



Satterlee Amputation Saw

29 cm / 11 1/2" **DMI-1981-026**



DMI-1981-027

Charriere Amputation Saw 27 cm / 10 1/2"



Satterlee Amputation Saw 23 cm / 9"

DMI-1981-028

AMPUSTION DSW - GIGLI SAW

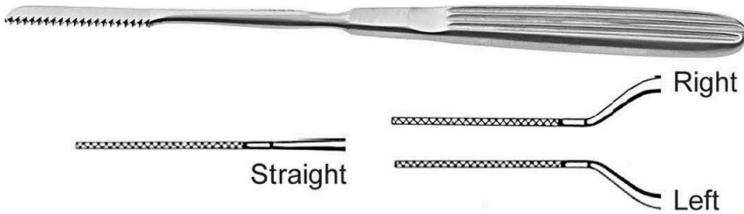

DMI-1981-029
Joseph Amputation Saw 18 cm / 7"

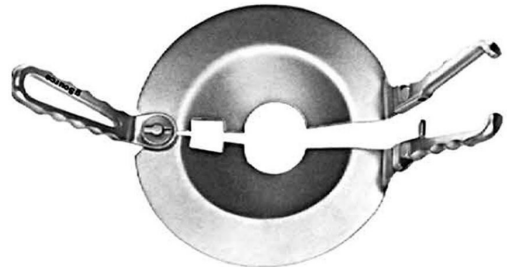

DMI-1981-030
Percy Amputation Shield 30 cm / 12"

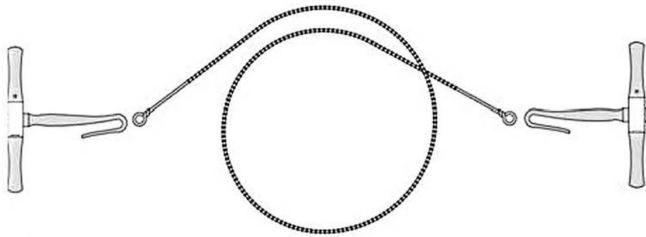

DMI-1981-031

- A: Gigli Saw 30cm
- B: Gigli Saw 50cm
- C: Tyler Gigli Saw (Large Cut) 30cm
- D: Tyler Gigli Saw (Large Cut) 30cm

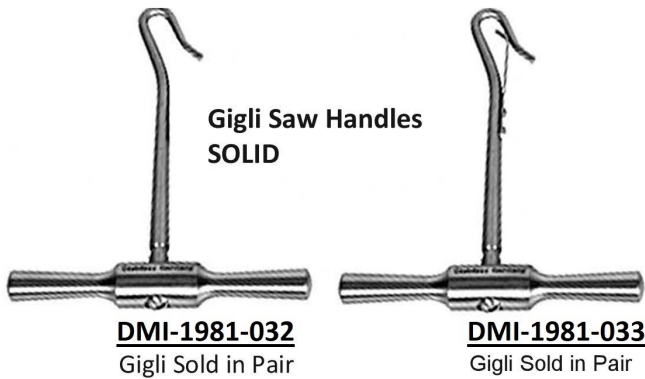

DMI-1981-034 Gigli Sold in Pair

DMI-1981-035 Gigli Sold in Pair

REMERS-AWLS-BONE HOOKS



DMI-1981-038

Reamer
13.5cm / 5 1/4"



DMI-1981-039

Perthes Reamer
18 cm / 7"



DMI-1981-040

Perthes Reamer
21.5 cm / 8 1/2"

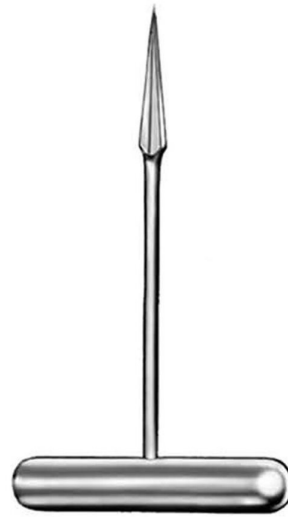

DMI-1981-041

Reamer One concave
side 14 cm / 5 1/2"

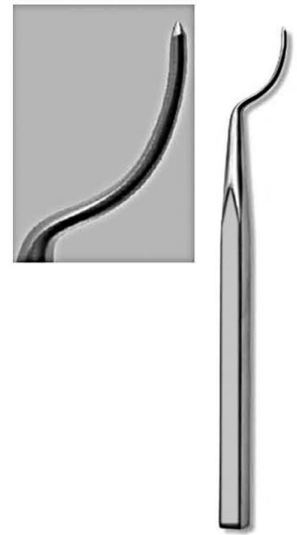

DMI-1981-042

Glenoid Punch
20 cm / 8"

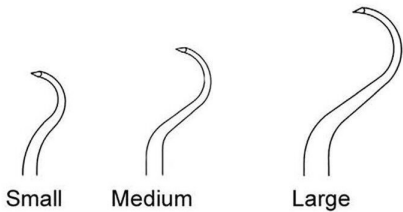

DMI-1981-043

Shoulder Percussion Awl A: 21 .5cm / 8 1/2" B: 23.5cm / 9 1/4"



A: 20cm / 8"
19X27mm
Sharp

B: 23cm / 9"
15X20mm
Blunt

C: 23cm / 9"
15X20mm
Sharp

C: 25cm / 9 3/4"
15X20mm
Sharp

DMI-1981-044

Volkman Bone Hook

REMERS-AWLS-BONE HOOKS



DMI-1981-045

Kuntscher Diamond Awl 28 cm / 11"

Pointed

DMI-1981-046

Rush Awl / Reamer

A: 19 cm / 7 1/2" 2.5mm

B: 21 cm / 8 1/4" 3mm

C: 21 cm / 8 1/2" 5mm

D: 26 cm / 10 1/2" 6mm

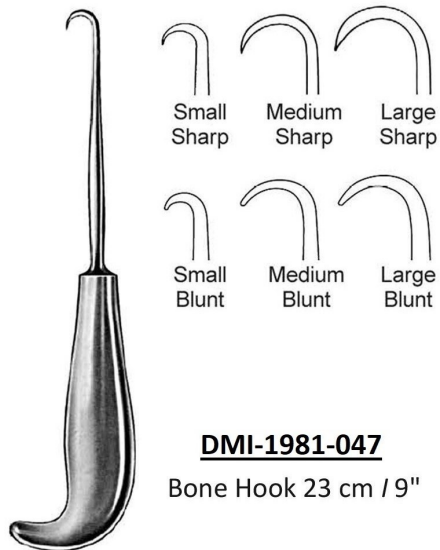

DMI-1981-047

Bone Hook 23 cm / 9"

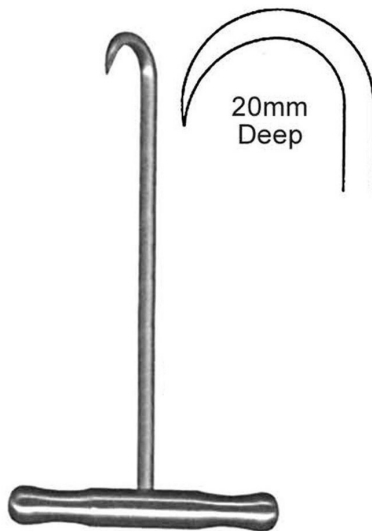

DMI-1981-048

Bone Hook T Handle 20 cm / 8"



DMI-1981-049

Bone Hook T Fiber Handle 14cm / 5 5/8"

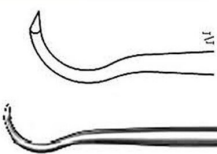

DMI-1981-050

Shoulder Penetrating Awl Fiber Handle

A: 18cm / 7" B: 23cm / 9"



DMI-1981-051

Pointed Awl Fiber Handle 25cm / 10"

ORTHOPEDIC HAND DRILLS & ACCESSORIES

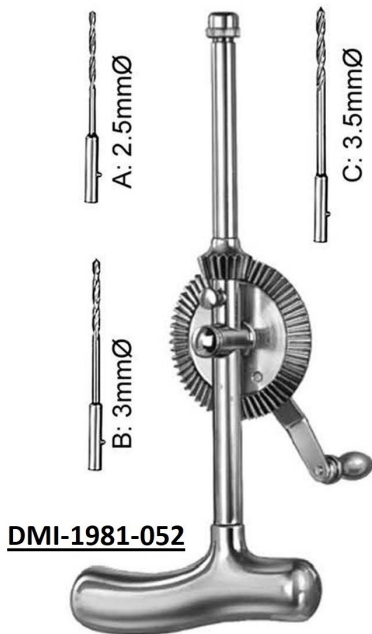

DMI-1981-052

Stille-Sherman Hand Drill
24 cm / 9 1/2" with 3 twist drills

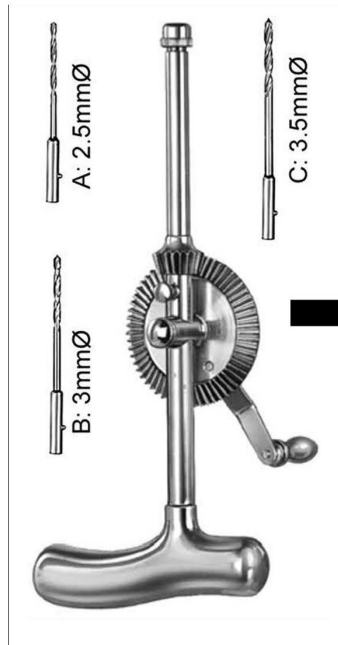

DMI-1981-053 Stille Hand Drill 20.5 cm / 8" w / 9 Twist Drills

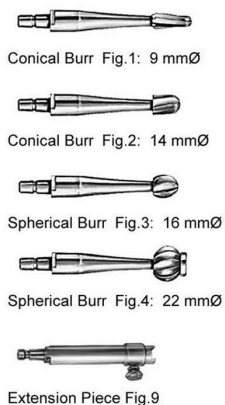
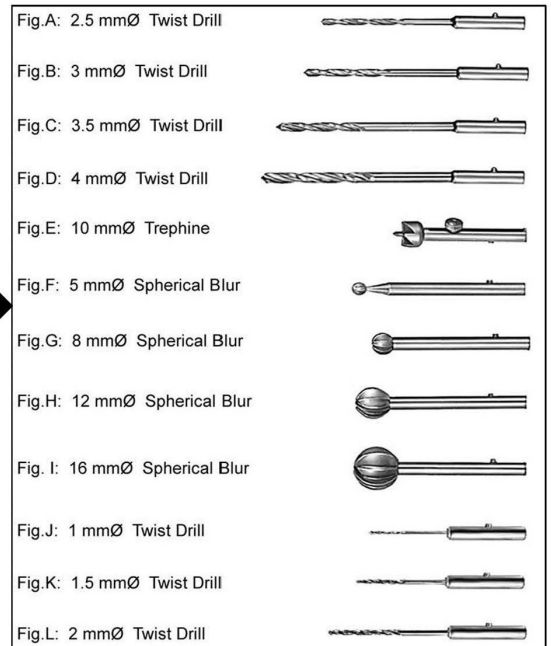

DMI-1981-054

Hudson Hand Drill
28 cm / 11"
Complete with burrs Fig #. 1 - 4
& additional price for additional
accessories

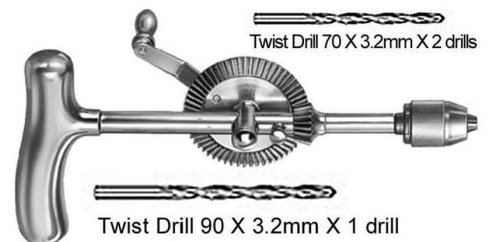
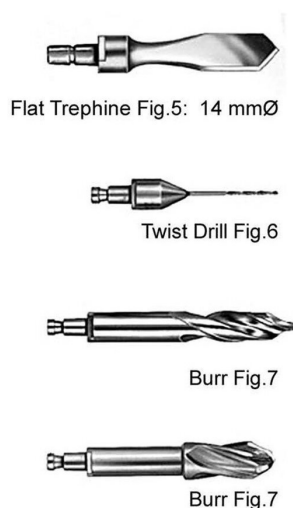

DMI-1981-055 Moore Hand Drill
Complete with a set of 3 twist drills

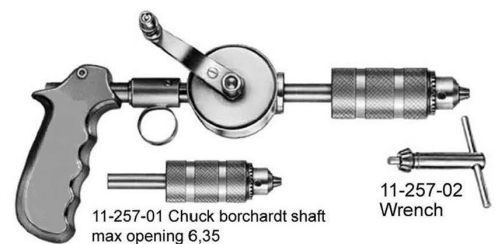

DMI-1981-056
Martin Hand Drill with Chuck & Wrench

ORTHPEDIC HAND DRILLS & ACCESSORIES



DMI-1981-057

Bunnell Hand Drill
16cm / 6-1/4"

Longitudinally Bored with 3-Jaw-Chuek
Light Metal Housing opening up to 4mm



DMI-1981-058

Bunnell Hand Drill
16cm / 6-1/4"

Twin Shade Powder Coated Longitudinally
bored with 3-Jaw-Chuek light metal
housing opening up to 4mm



Ralk Hand Drill
DMI-1981-059

Light Metal Housing
Literally Angled Handle with 3-Jaw-Chuek
and key, opening up to 6,35mm

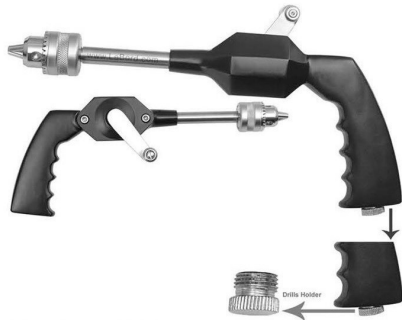
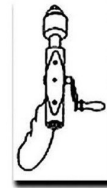

DMI-1981-060

HAND DRILL
All Covered Polished / Dull or Coated.
Drills Holder at Bottom.



DMI-1981-061

Hand Drill
All Covered Light Weight / Polished /
Dull or Coated. Key Holder and Self
Retaining Locking Mechanism



Box for Hand Drills
Outside Artificial Leather
/ inside Jumbo Foam



DMI-1981-062

Hand Drill
Polished / Dull or Coated. Operated
Horizontally and Vertically

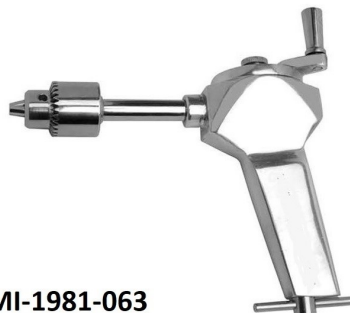

DMI-1981-063

Hand Drill
Polished / Dull or Coated.
All Covered

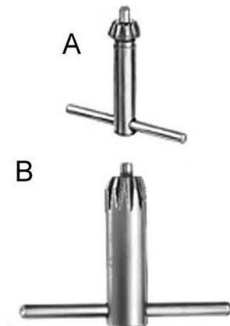

All Hand Drills
Provided with Keys

ORTHOPEDIC HAND DRILLS & ACCESSORIES



DMI-1981-064

Hand Drill
Polished / Dull
Or Coated.
Open Housing

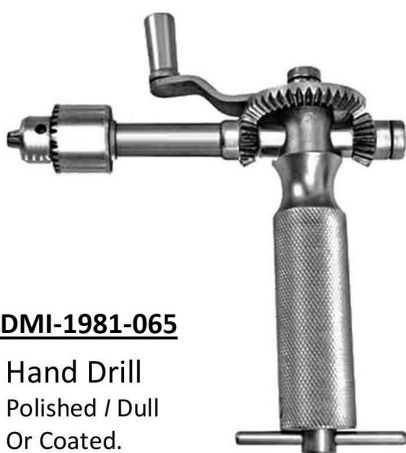

DMI-1981-065

Hand Drill
Polished / Dull
Or Coated.
Open Housing



DMI-1981-066

Hand Drill
Polished / Dull
Or Coated.
Semi Closed Housing



DMI-1981-067

Vickers Easidriver 14 Cm / 5 1/2"



DMI-1981-068

14 cm / 5 1/2"
Handle W/ Chuck Longitudinally
Bored Accommodating up to 3,95mm



DMI-1981-069

Handle with chuck T-Shaped



DMI-1981-070

Fiber T-Handle Key



DMI-1981-071

Key



DMI-1981-072

Key

ORTHOPEDIC HAND DRILLS & ACCESSORIES

DMI-1981-073



5mm Borchardt Shaft Twist Drill, Long Working End
A: 2.0mm B: 2.5mm C: 3.0mm D: 3.2mm E: 3.5mm F: 4.0mm G: 5.0mm H: 6.0mm I: 7.0mm

DMI-1981-074



5mm Borchardt Shaft Twist Drill
A: 1.0mm B: 1.5mm C: 1.8mm D: 2.0mm E: 2.2mm F: 2.5mm G: 2.8mm H: 3.0mm I: 3.2mm J: 3.5mm K: 4.0mm L: 5.0mm

DMI-1981-075



5mm Borchardt Shaft Flat Trepine
A: 1.8mm B: 2.0mm C: 2.2mm D: 2.5mm E: 3.0mm F: 3.5mm G: 4.0mm H: 5.0mm



DMI-1981-076
5mm Borchardt Shaft Spherical Burr
A: 3.0mm B: 4.0mm



DMI-1981-077
5mm Borchardt Shaft Spherical Burr
A: 3.0mm B: 5.0mm



Long 5mm Borchardt Shaft

DMI-1981-078
Doyen Spherical Burr
A: 4mm B: 6mm C: 8mm D: 10mm E: 12mm F: 14mm G: 16mm

Short 5mm Borchardt Shaft



DMI-1981-079
Doyen Spherical Burr
A: 4mm B: 6mm C: 8mm D: 10mm E: 12mm F: 14mm G: 16mm

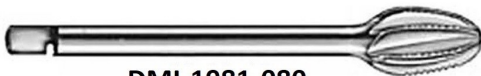

DMI-1981-080
Doyen Conical Burr
Coarse Spacing 12mm Dia

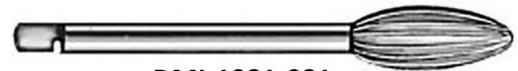

DMI-1981-081
Doyen Conical Burr
Fine Spacing A: 8mm / B: 10 mm



DMI-1981-082
Doyen Cylindrical Burr
Coarse Spacing A: 12mm / B: 15mm



DMI-1981-083
Albee Burr Oval Coarse Spacing
A: 8mm / B: 10 mm / C: 12 mm



DMI-1981-084
Albee Burr Pointed 7 mm



DMI-1981-085
Borchardt Burr Oval Coarse Spacing 13mm



DMI-1981-086
Flat Burr Short Borchardt Shaft 25mm



DMI-1981-087
Toti Trepine Short Borchardt Shaft 8mm

BONE HOLDING CLAMPS –TRACTION BARS



DMI-1981-088

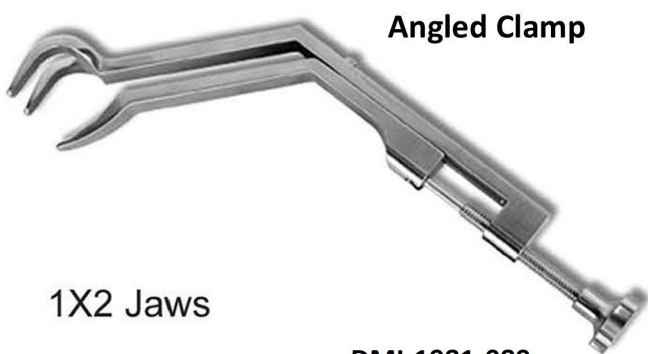
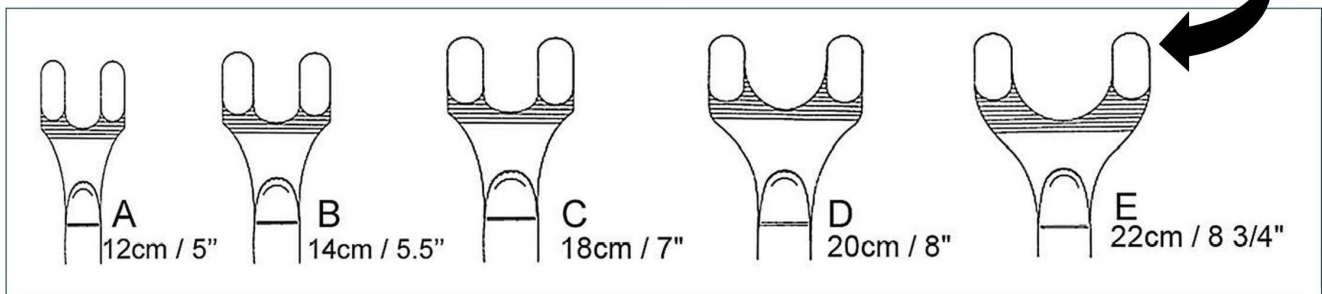
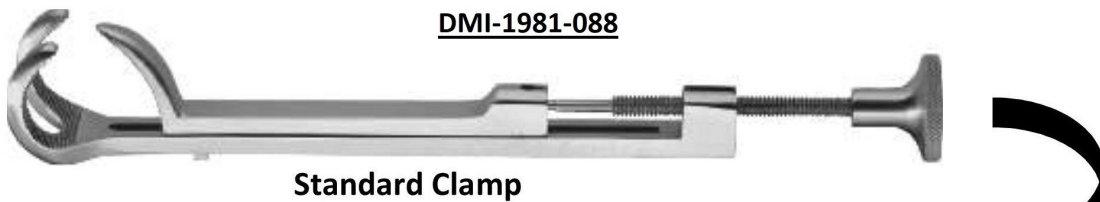

DMI-1981-089

Gerster-Lowman Bone Holding Clamp

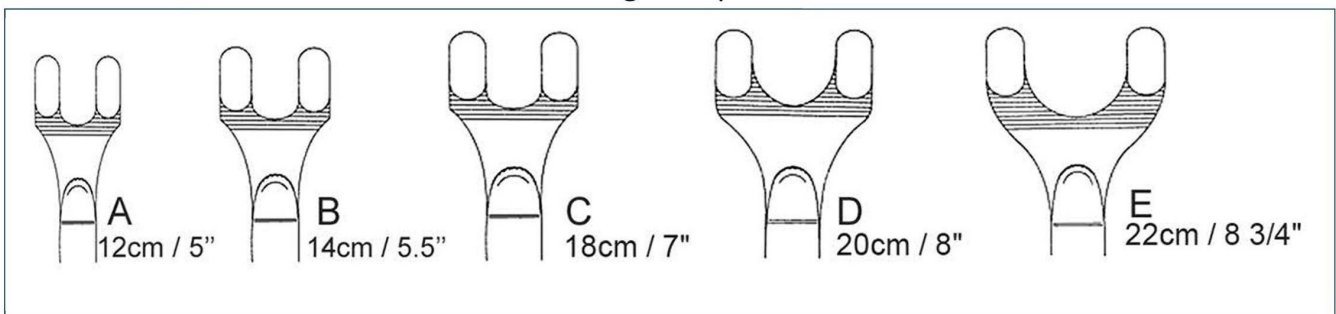
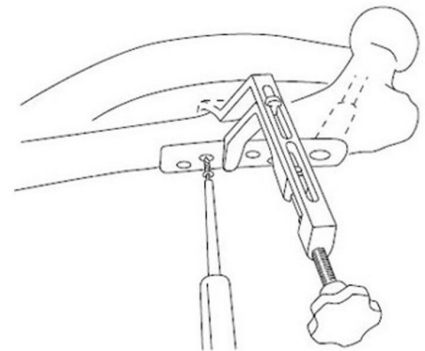

BONE HOLDING CLAMPS –TRACTION BARS



DMI-1981-090

Gerster Traction bar 15 cm / 6"

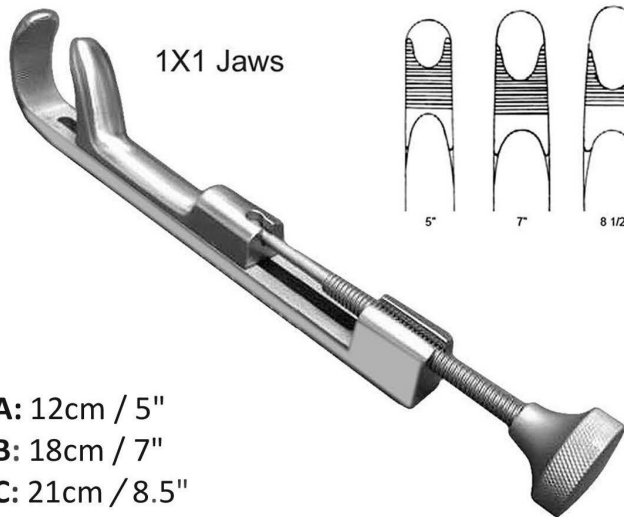

A: 12cm / 5"
B: 18cm / 7"
C: 21cm / 8.5"

DMI-1981-091

Gerster-Lowman Bone Holding Clamp

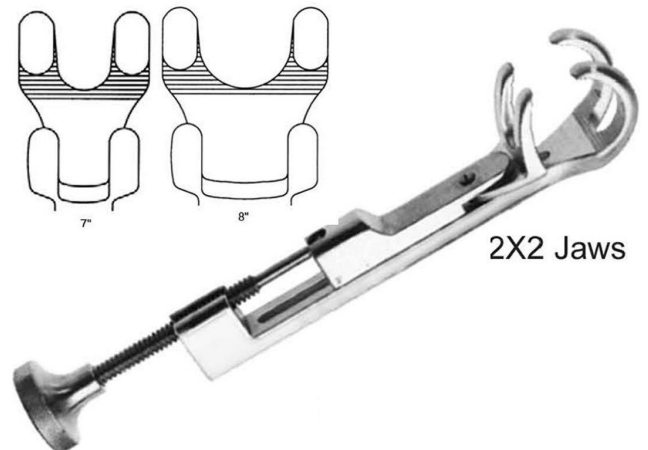

A: 18cm / 7"
B: 20cm / 8"

DMI-1981-092

Gerster-Lowman Bone Holding Clamp

WISE GRIPS— NOVE PLIERS— SLAP HAMMERS



DMI-1981-093

Vise Grip Locking Plier 23 cm / 9"



DMI-1981-095

Vise Grip Locking Plier 20.5 cm / 8"



DMI-1981-097

Vise Grip Locking Plier 18 cm / 7"

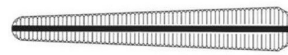

DMI-1981-094

Needle Nose Locking Plier 30 cm / 12"



DMI-1981-096

Needle Nose Locking Plier 25.5 cm / 10"

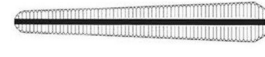

DMI-1981-098

Needle Nose Locking Plier 22 cm / 8.5"

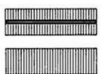

DMI-1981-099

Flat Nose Plier 18.5 cm / 7 ¼" Parallel Grip SS

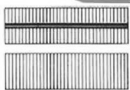

Max1.6mm Cutting Capacity

DMI-1981-101

Flat Nose Plier-Cutter 18.5 cm / 7 ¼" Parallel Grip SS



DMI-1981-100

Long Nose Plier 22 cm / 8 ½"

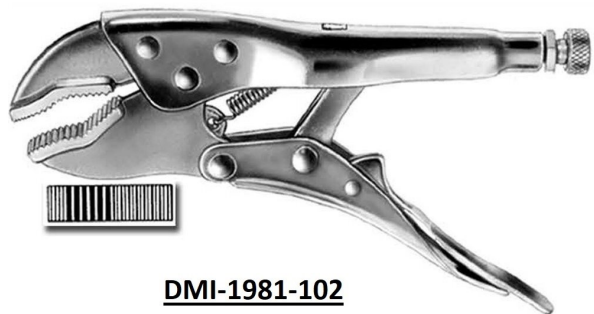

DMI-1981-102

Vise Grip 20.5 cm / 8" Stainless Steel

WISE GRIPS– NOVE PLIERS– SLAP HAMMERS



DMI-1981-103

Regular Jaw Locking Plier

A: 18 cm / 7" B: 20 cm / 8" C: 23 cm / 9"



DMI-1981-104

Needle Nose Locking Plier

A: 22 cm / 8.5" B: 25.5 cm / 10" C: 30 cm / 12"



DMI-1981-105

SLAP HAMMER w/ Threaded Shaft Head



DMI-1981-106

SLAP HAMMER w/ Hexa Shaft Head



DMI-1981-107

Combi-Fiat Nose Pliers 15 cm / 6"
For Bending & Cutting



DMI-1981-108

Flat Nose Plier 13.5 cm / 5 ¼"



DMI-1981-109

Round / Flat Nose Pliers 18 cm / 7"



DMI-1981-110

Hackstock Flat Nose Pliers 16 cm / 6 ¼"

with longitudinal groove

NOSE PLIERS—PULLING FORCEPS— WIRE CUTTERS

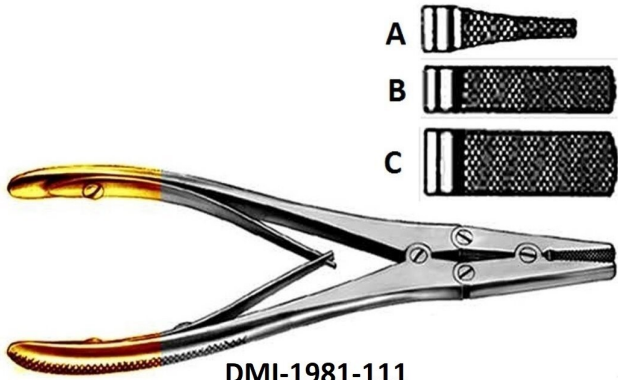

DMI-1981-111
Flat Nose Pliers 18 cm / 7" Parallel Grip



DMI-1981-112
Flat Nose Pliers 17 cm / 6 ¾" with crosswise groove



DMI-1981-113
Flat Nose Pliers 17.5 cm / 7"



DMI-1981-114
Flat Nose Pliers Pointed 19.5 cm / 7 ¾"



DMI-1981-115
Platypus Nail Pulling Forceps 15.5 cm / 6 ¼"

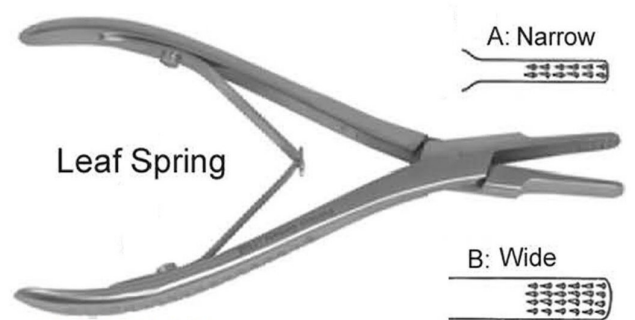

DMI-1981-116
Platypus Nail Pulling Forceps 15.5 cm / 6 ¼"



DMI-1981-117
Round Nose Pliers 15.5 cm / 6 ¼"



DMI-1981-118
Needle Nose Pliers 15.5 cm / 6 ¼"

NOSE PLIERS—PULLING FORCEPS— WIRE CUTTERS

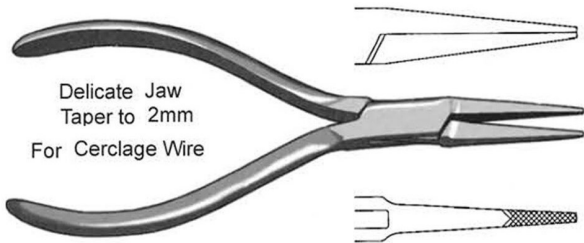

Delicate Jaw
Taper to 2mm
For Cerclage Wire

DMI-1981-119

Flat Nose Pliers 15 cm / 6"

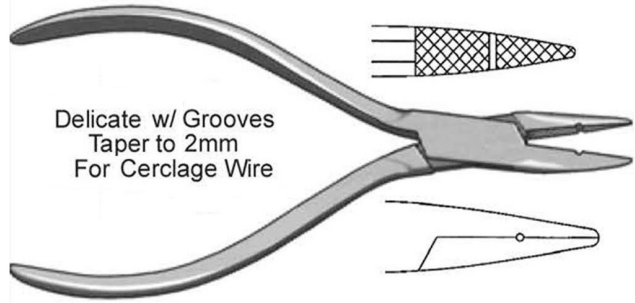

Delicate w/ Grooves
Taper to 2mm
For Cerclage Wire

DMI-1981-120

Needle Nose Pliers 13.5 cm / 5 ¼"

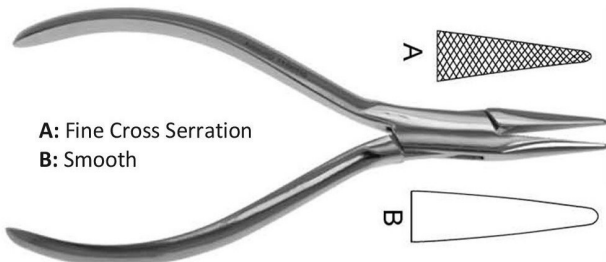

A: Fine Cross Serration
B: Smooth

DMI-1981-121

Needle Nose Pliers Taper to 2mm Tip 14 cm / 5 ½"

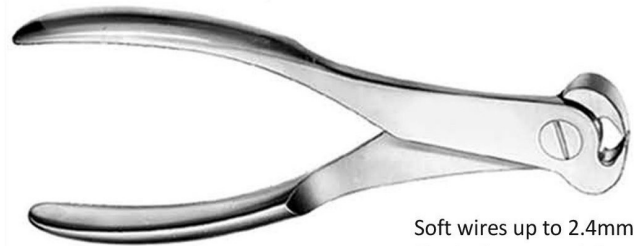

Soft wires up to 2.4mm
Hard wires up to 1.8mm

DMI-1981-122

Wire Cutting Pliers 18.5 cm / 7 ¼"

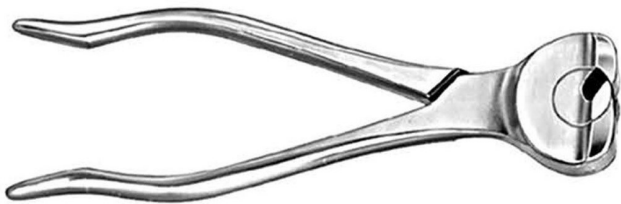

DMI-1981-123

Martin "Diamant" 16cm / 6 ¼"



Delicate w/ Grooves
Taper to 2mm
For Cerclage Wire

DMI-1981-124

Circlage Pliers / Cutter 14 cm / 5 ½"

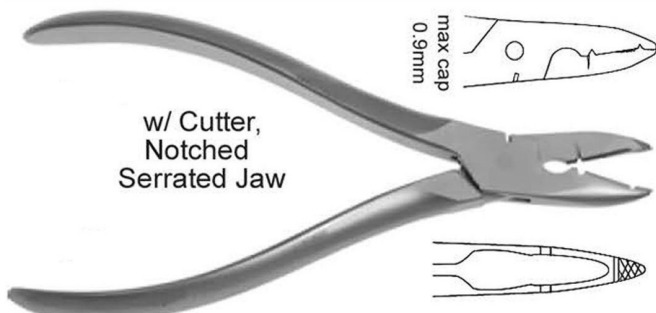

w/ Cutter,
Notched
Serrated Jaw

max cap
0.9mm

DMI-1981-125

Wire Bending Pliers 20 cm / 8"

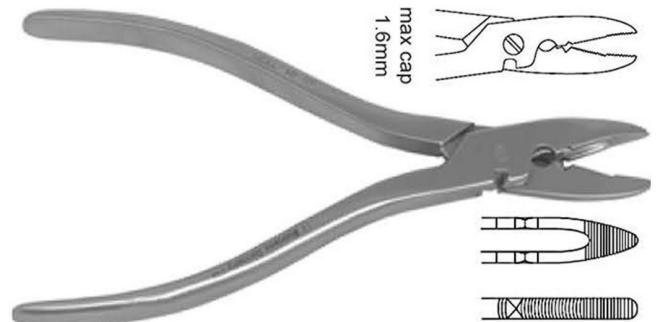

max cap
1.6mm

DMI-1981-126

Wire Bending Pliers 15 cm / 6"

NOSE PLIERS—PULLING FORCEPS— WIRE CUTTERS



DMI-1981-127

Wire Bending Pliers TC 20 cm / 8"

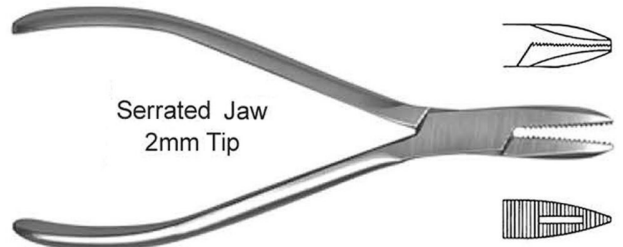

Serrated Jaw
2mm Tip

DMI-1981-128

Needle Nose Pliers 15 cm / 6"

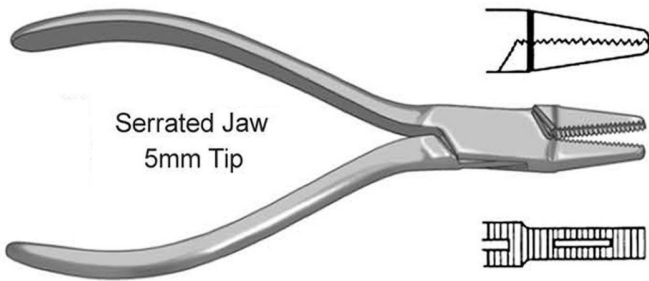

Serrated Jaw
5mm Tip

DMI-1981-129

Flat Nose Pliers 14 cm / 5 1/2"

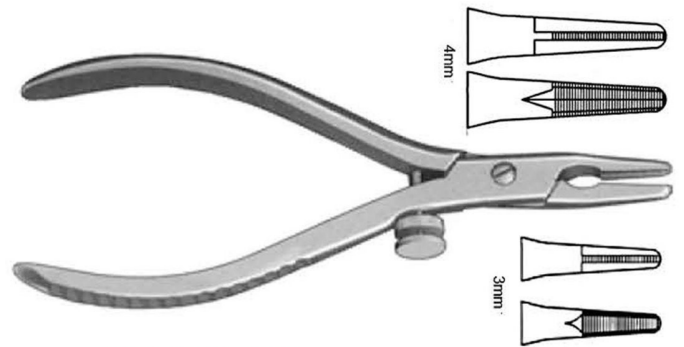

DMI-1981-130

K-Wire Pliers **A:** 13 cm / 5" **B:** 17.5 cm / 7"

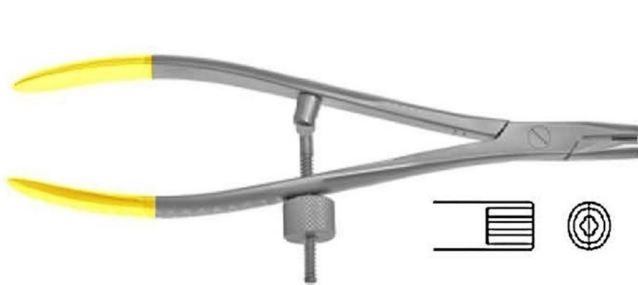

DMI-1981-131

Screw/Pin Removing Pliers 19 cm / 7 1/2"

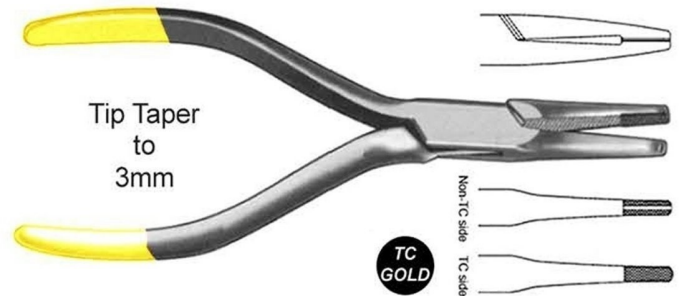

Tip Taper
to
3mm

DMI-1981-132

Pin Puller Grips Small Pins 14 cm / 5 1/2"



Tip Taper
to
3.5mm

DMI-1981-133

Flat Nose Pliers w/ Cutter for Cerclage Wire 16 cm / 6 1/2"



Tip Taper
to
3.5mm

DMI-1981-134

19 cm / 7 1/2" Narrow Nose Pliers Heavy Jaws
for Pulling Wire / Pins

PLIERS– BANDERS– ROD INSTRUMENTS

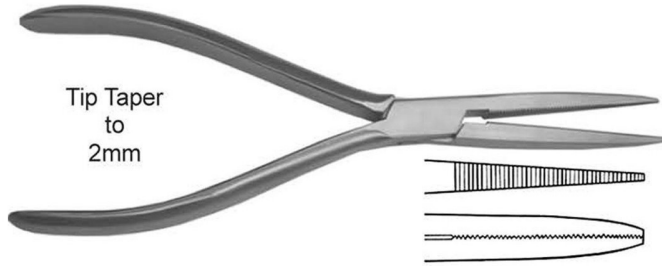

DMI-1981-135
Long Jaw Pliers 2inch Long Jaw Delicate 17.5 cm / 7"

- A: 17.5 cm / 7" Needle Nose 2" Jaw
- B: 16 cm / 6 1/2" Square 7mm Jaw
- C: 18 cm / 7" Tape to 2mm Tip

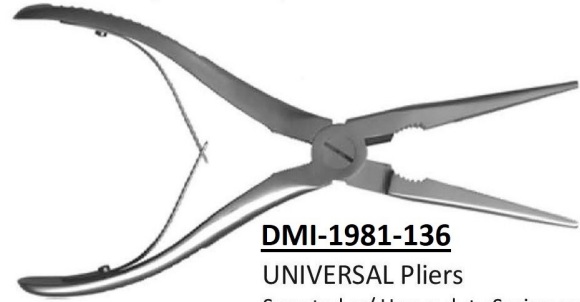
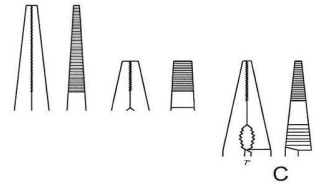

DMI-1981-136
UNIVERSAL Pliers
Serrated w/ Heavy duty Spring and Cutting Edge
Max Cutting Cap: 1.1 mm

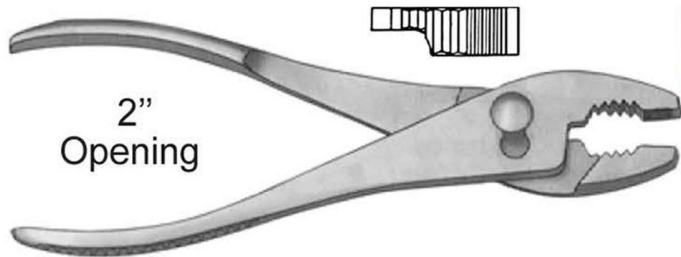

DMI-1981-137
Slip Joint Pliers 20 cm / 8"

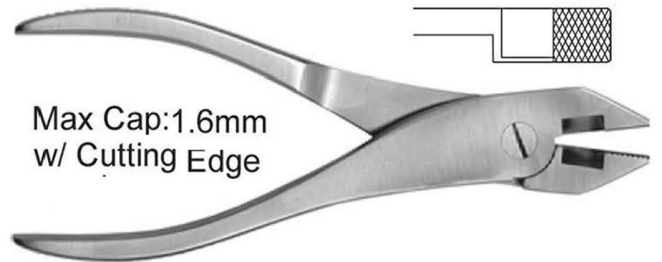

Max Cap: 1.6mm
w/ Cutting Edge

DMI-1981-138
Lineman Pliers 21 cm / 8 1/2"

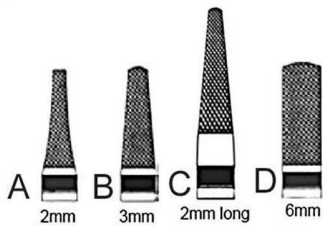
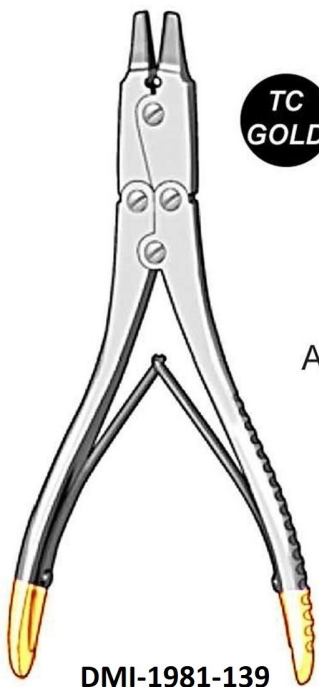

- A: 2mm Delicate Jaw TC
- B: 3mm Jaw TC
- C: 2mm Long Jaw TC
- D: 6mm Jaw TC

DMI-1981-139
Double Action Wire Extraction Plier
18 cm / 7"

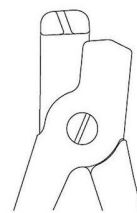
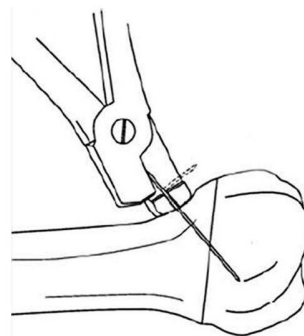

DMI-1981-140
Gratloch Wire Bender
19 cm / 7 1/2"

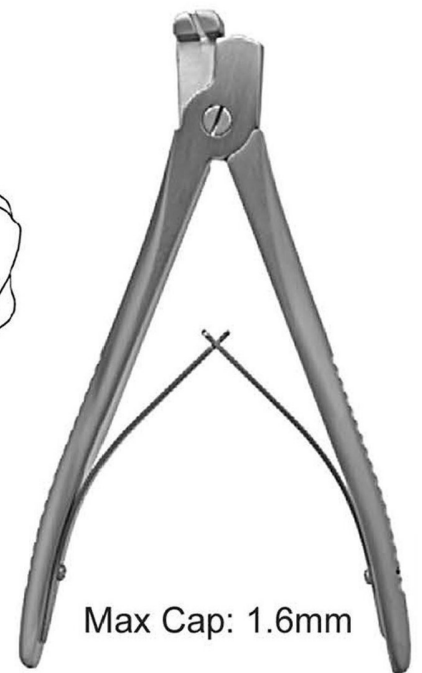

PLIERS- BANDERS- ROD INSTRUMENTS

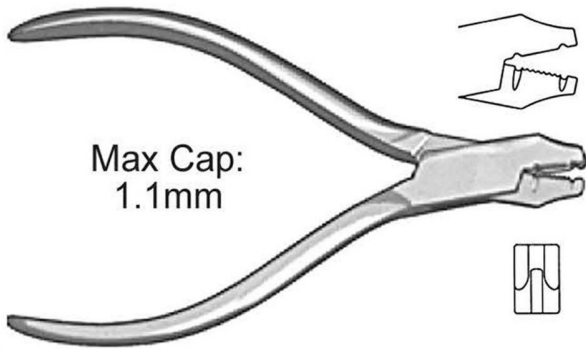

Max Cap:
1.1mm

DMI-1981-141

K-Wire / Plate Bender 13.5cm / 5"

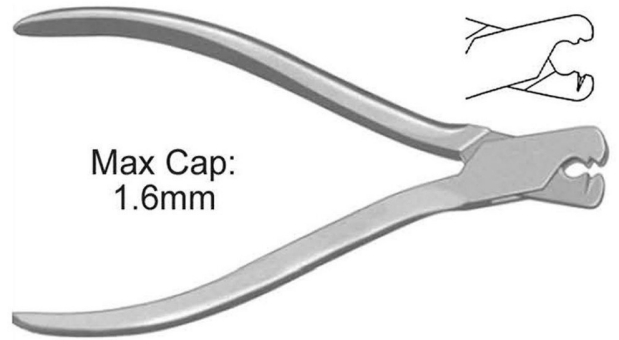

Max Cap:
1.6mm

DMI-1981-142

K-Wire / Plate Bender 14.5 cm / 5 1/2"

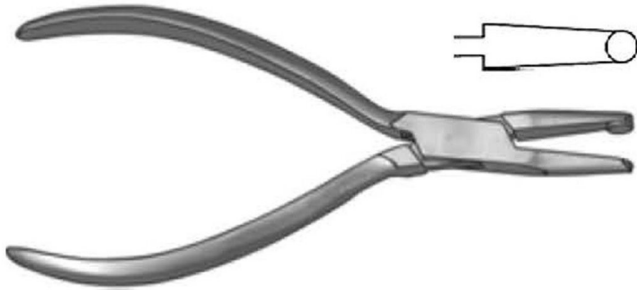

DMI-1981-143

Mini Plate Bending Pliers 13.5 cm / 5"

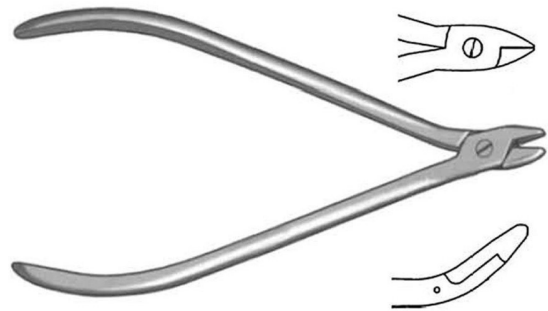

DMI-1981-144

Plate Bending Pliers 14.5 cm / 5 1/2"

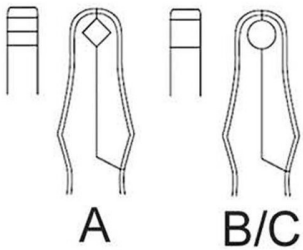

- A: 5.5mm Rods Prism
- B: 5.5mm Rods
- C: 6.35mm Rods

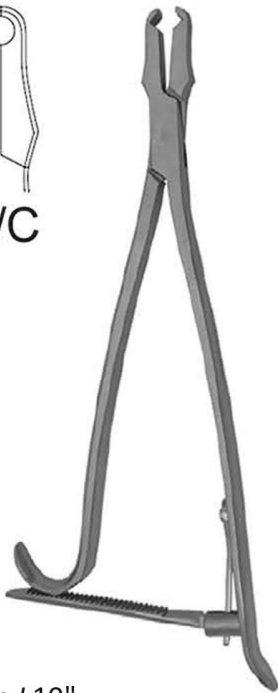

DMI-1981-145

Rod Holder STR 25 cm / 10"

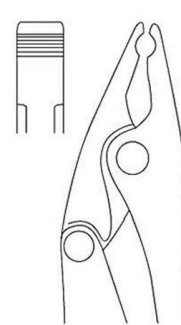

DMI-1981-146

Rod Gripper Adjustable
21 cm / 8 1/2"

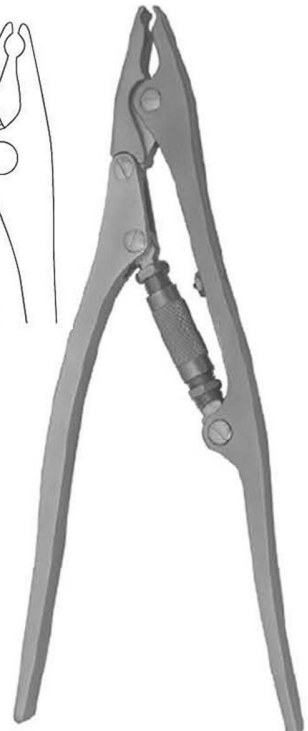

WIRE INSTRUMENTS— EXTANSION BOWS

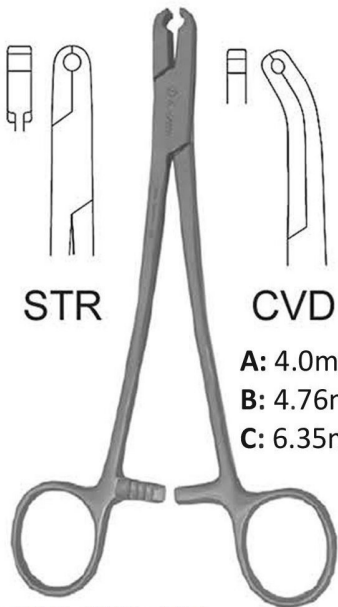

STR

CVD

- A: 4.0mm Rod
- B: 4.76mm Rod
- C: 6.35mm Rod

DMI-1981-147

Rod Holder 18 cm / 7 ¼"

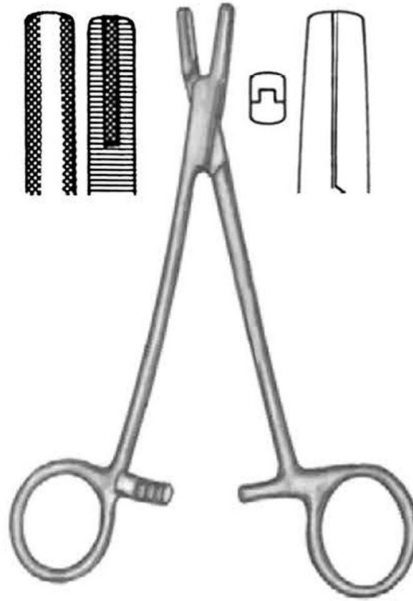

DMI-1981-148

Wire Pulling Forceps 16 cm / 6 ½"

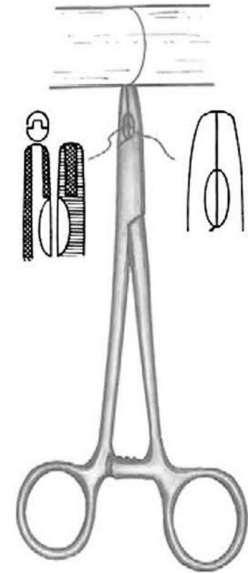

DMI-1981-149

Wire Twister / Tightner 16cm / 6 ¼"



DMI-1981-150

Loute Wire Tightener 21 cm / 8 ¼"



DMI-1981-152

Wire Tightener w / T Handle
11.5 cm / 4 ½"



DMI-1981-151

Wire Tightener 12 cm / 4 ¾"

WIRE INSTRUMENTS– EXTANSION BOWS

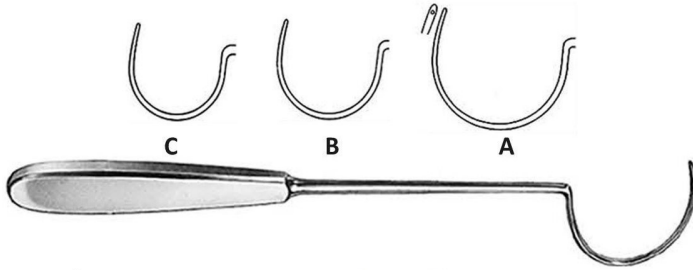

A: 31 cm / 12 ¼"
B: 29 cm / 11 ½"
C: 28 cm / 11"

DMI-1981-153
Demel Wire Guide

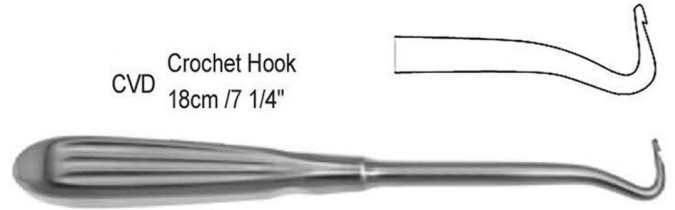

CVD Crochet Hook
18cm / 7 1/4"

DMI-1981-154
Bankert Ligature Carrier

CVD
Crochet Hook Fiber handle
A: 18cm / 7" B: 23cm / 9"



DMI-1981-155
Suture Passer

CVD
Suture Hole Fiber Handle
A: 18cm / 7" B: 23cm / 9"



DMI-1981-156
Suture Passer



Suture Hole
20cm / 8"
A: Right Blunt
B: Left Blunt
C: Right Sharp
D: Left Sharp

DMI-1981-157
Deschamps Ligature Carrier

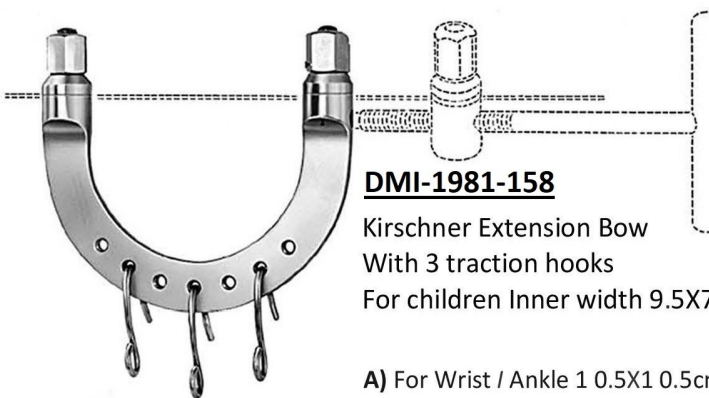

DMI-1981-158
Kirschner Extension Bow
With 3 traction hooks
For children Inner width 9.5X7cm

A) For Wrist / Ankle 1 0.5X1 0.5cm
B) For Elbow 12X12cm
C) For Knee 15.5X15.5cm
D) For Femur 20X15.5cm

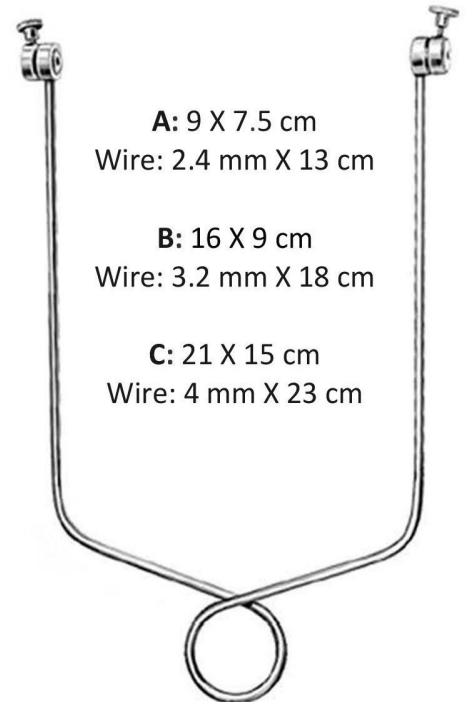

A: 9 X 7.5 cm
Wire: 2.4 mm X 13 cm
B: 16 X 9 cm
Wire: 3.2 mm X 18 cm
C: 21 X 15 cm
Wire: 4 mm X 23 cm

DMI-1981-159
Bohler Extension Bow for femur & knee **22**

WIRE INSTRUMENTS– EXTANSION BOWS

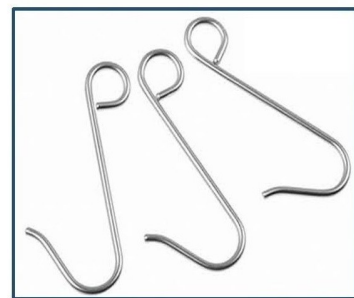
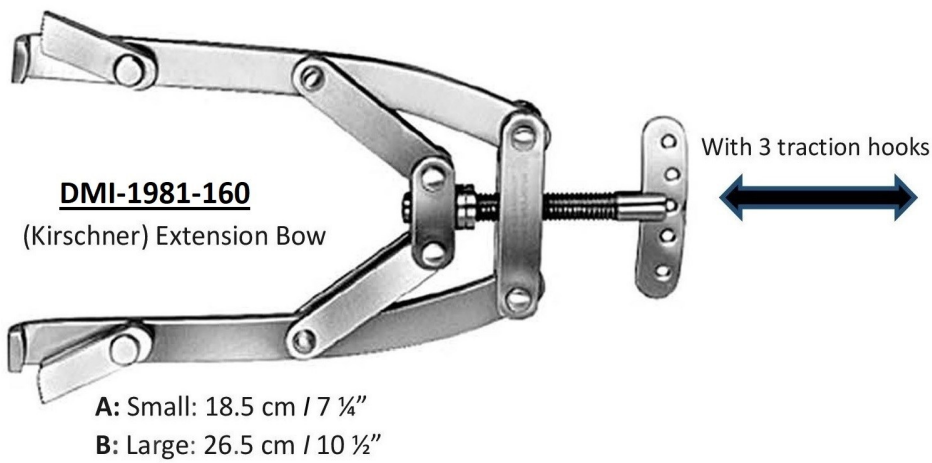

**Traction Hook
For Extension Bows**



DMI-1981-163
Extension Bow
A: 10 ½" X 6 ¼"
B: 7" X 4"



DMI-1981-161
Wire Strainer 18.5 cm / 7 ¼"



DMI-1981-162
Wrench 20 cm / 8"



DMI-1981-164
Fixation Discs
For wire drills, pair

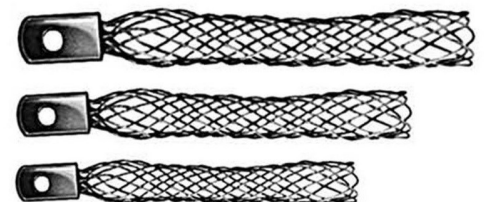

DMI-1981-165
Extension Sleeve
Small / Medium / Large

RING CUTTERS— LEAD HANDS— BIPOSY TOOLS

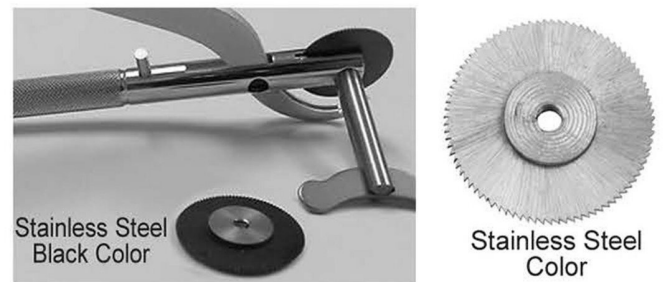
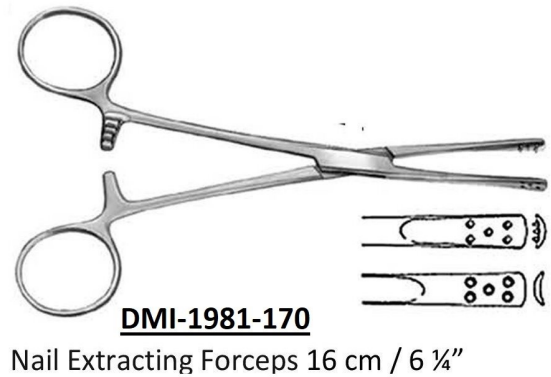

Finger Ring Saw Cutter Spare

RING CUTTERS- LEAD HANDS- BIPOSY TOOLS



DMI-1981-175

Lead Hand for Kids / Adults



DMI-1981-176

Lead Hand for Kids / Adults

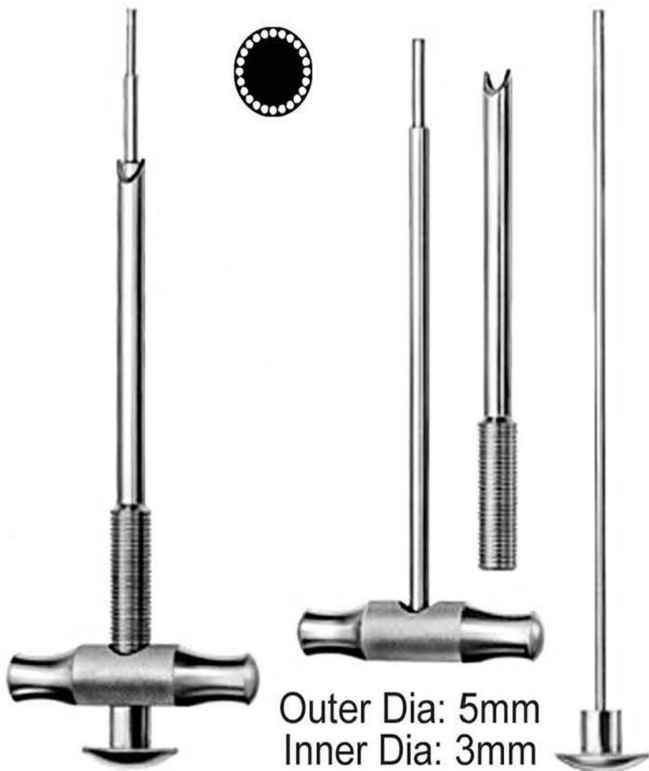

Outer Dia: 5mm
Inner Dia: 3mm

DMI-1981-177

Champy-OSU Bone Biopsy Instruments
22 cm / 8 ¾"

Consisting of trocar, a toothed trephine and a plunger for taking tibial and iliac bone grafts through a closed technique

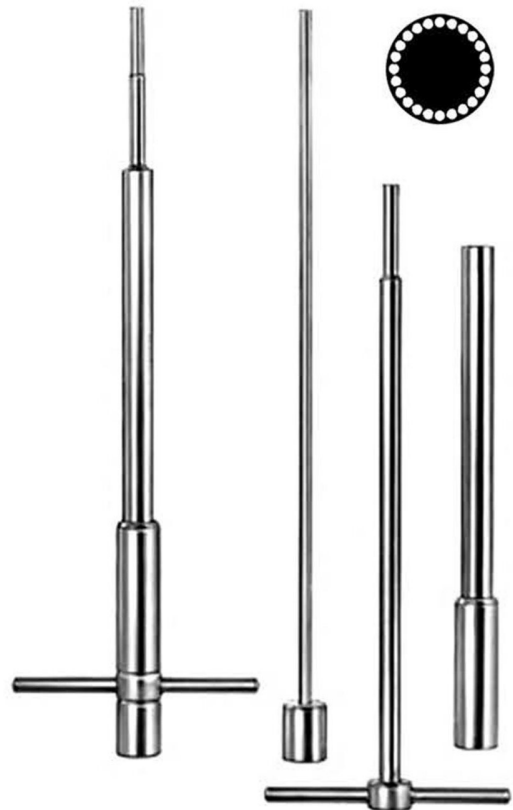

DMI-1981-178

Champy Bone Biopsy Instruments
22 cm / 8 ¾"

- A) Outer Dia: 5mm / Inner Dia: 4mm
- B) Outer Dia: 8mm / Inner Dia: 7mm

BONE TEMPERS—IMPACTORS—PACKERS



DMI-1981-179

Bone Tamper

15.5 cm / 6" Tip

Sizes: 2-3-4-5-6-8-9-10 mm



DMI-1981-180

Champy Cancellous Bone graft Mill

Outer Dia: 17mm

Inner Dia: 16mm

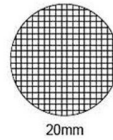

DMI-1981-181

Bone Impactor / Teflon Tip 17cm / 6 1/2"



DMI-1981-182

Caspar Bone Tamper 20 cm / 8"



DMI-1981-183

Lumbar / Cervical Impactor 21cm / 8 1/2"

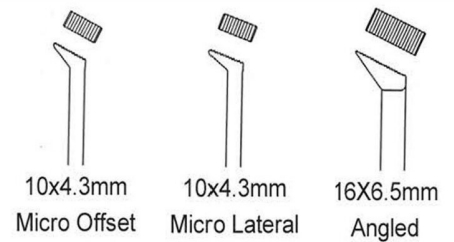

DMI-1981-184

Lumbar / Cervical Impactor 21cm / 8 1/2"

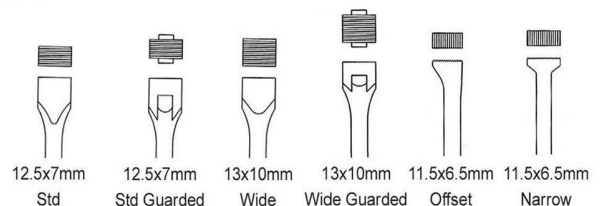

BONE RASPS- FILES



DMI-1981-185
Bone Chip Packer 25cm / 10"

A: 2.X9mm B: 3X16mm
C: 6X9mm D: 6X19mm
E: 6mm Dia

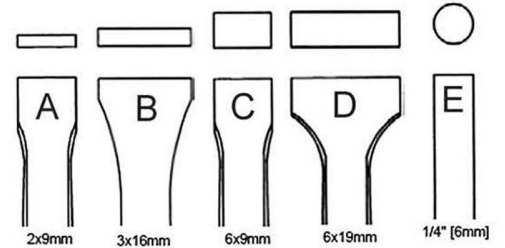

DMI-1981-186
Bone Tamper 43 cm / 17"

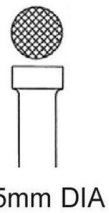

DMI-1981-187
Putti Bone Rasp Round / Semi Round
30 cm / 11 3/4"



DMI-1981-188
Putti Bone Rasp Curved / Straight
27cm / 10 3/4"



DMI-1981-189
Bone File 28 cm / 11" w/ Hollow Handle Semi Round



DMI-1981-190
Bone File 24.5 cm / 9 3/4" w/ Hollow Handle Semi



DMI-1981-191
Bone File 22 cm / 8 3/4" Flat / Round



DMI-1981-192
Bone Rasp 22 cm / 8 3/4" Flat / Round



DMI-1981-193
Bone File Fiber Handle 18cm / 7"

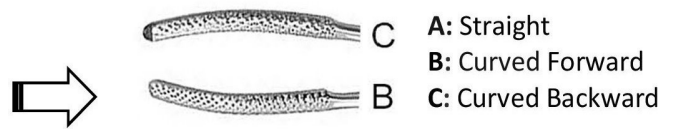

DMI-1981-194
Bone File 18 cm / 7" Fiber Handle / Cross-Hatch



DMI-1981-195
Bone File 18 cm / 7" Fiber Handle / Linear **27**

BONE RASPS- FILES

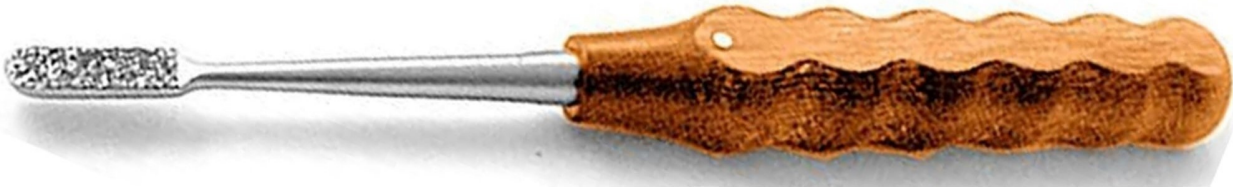

DMI-1981-196

Bone File 18 cm / 7" Fiber Handle / STR Diamond Coated



DMI-1981-197

Bone File 18 cm / 7" Fiber Handle / CVD Diamond Coated

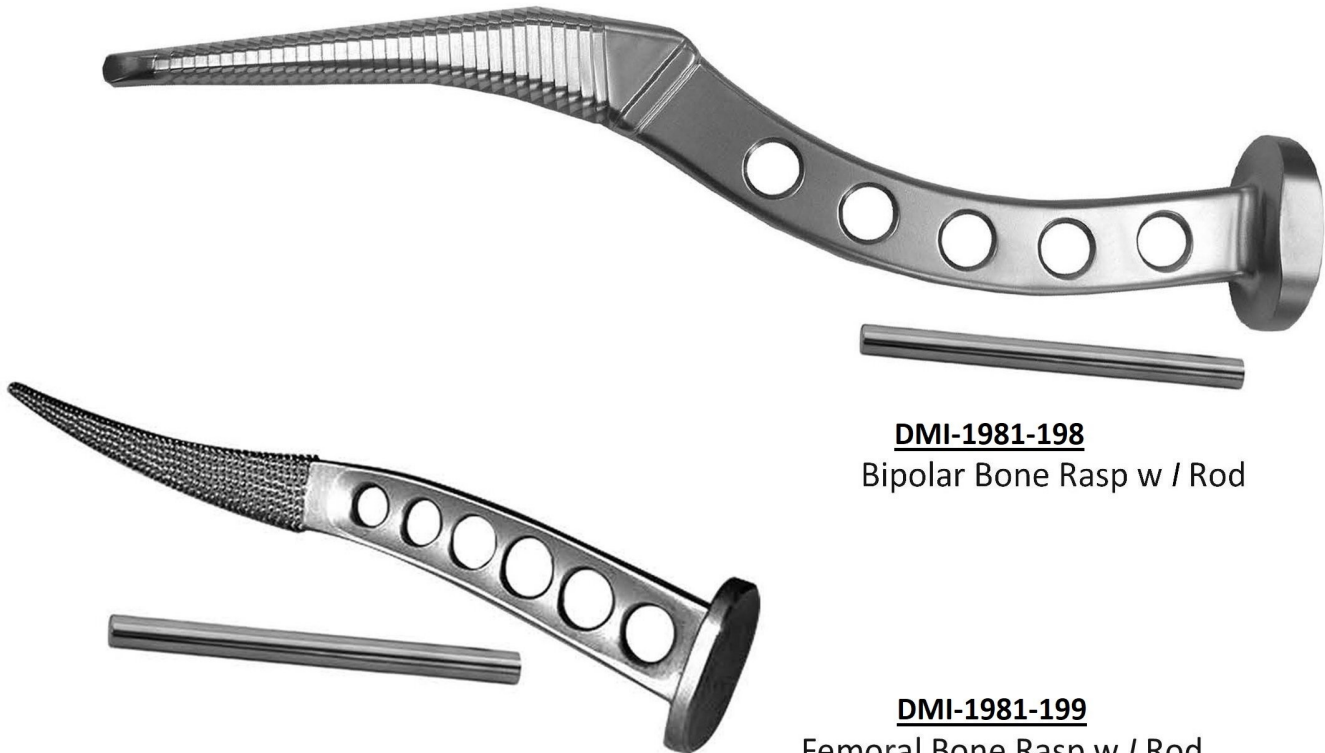

DMI-1981-198

Bipolar Bone Rasp w / Rod

DMI-1981-199

Femoral Bone Rasp w / Rod

A: Small B: Medium C: Large

BONE RASPS- FILES

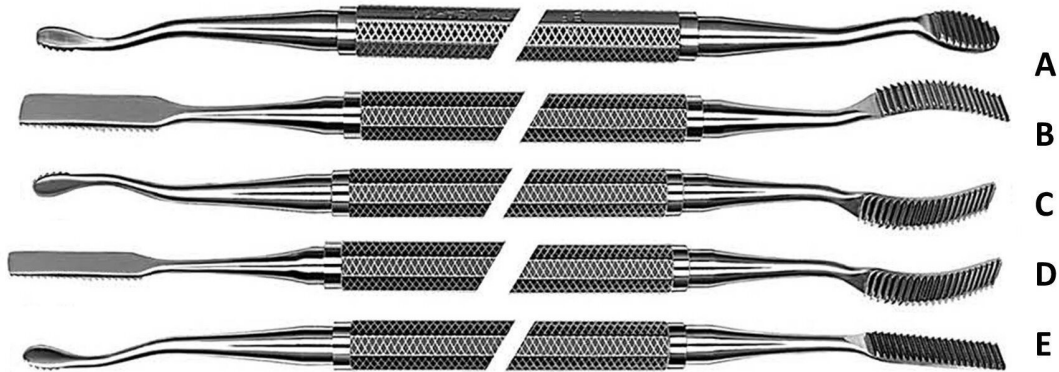

DMI-1981-200

Miller-Colburn Bone File 18 cm / 7" Downwards Cut

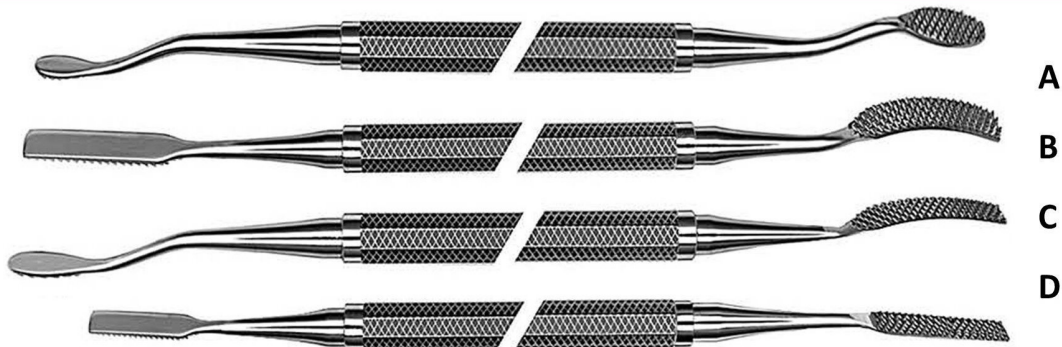

DMI-1981-201

Miller-Colburn Bone File 18 cm / 7" Cross Cut

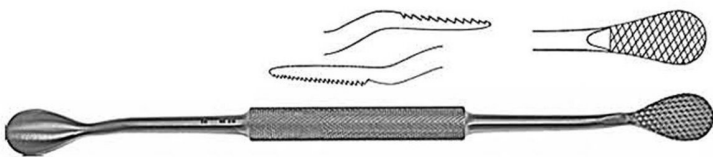

DMI-1981-202

Bone Rasp 21 cm / 8.5" 13mm Fine/Coarse
Straight

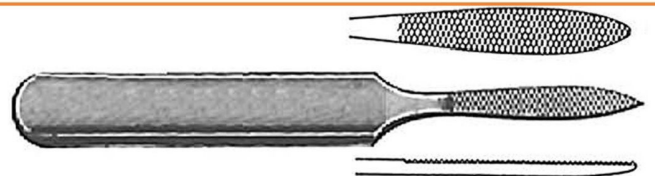

DMI-1981-203

Bone Rasp Joseph 16 cm / 6.25" 8mm
Fine Cross Serrated / Straight

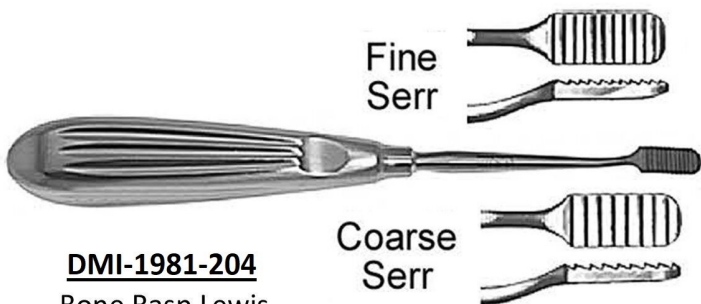

DMI-1981-204

Bone Rasp Lewis
19 cm / 7.5" 8mm

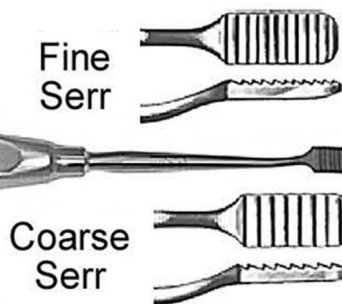

Fine
Serr

Coarse
Serr

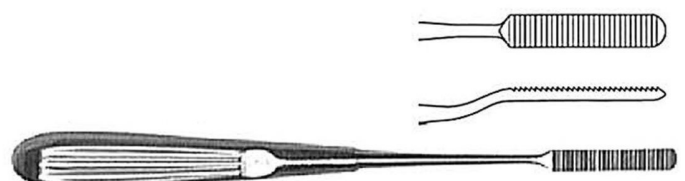

DMI-1981-205

Bone Rasp Cottle
20 cm / 8" 7mm Plain Serrated Downward

BONE RASPS- FILES

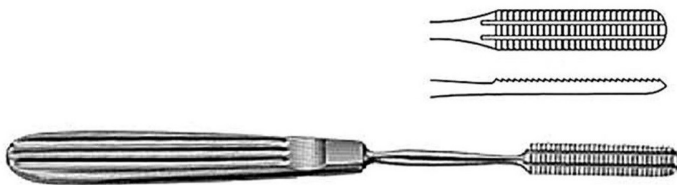

DMI-1981-206

Bone Rasp Maltz 18 cm / 7"
9mm Plain Coarse Serr Downward

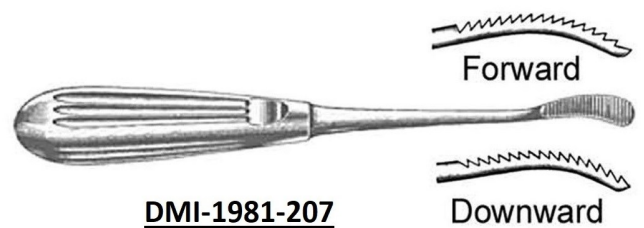

DMI-1981-207

Bone Rasp Aufriecht 18 cm / 7"
9mm Coarse Serr CVD

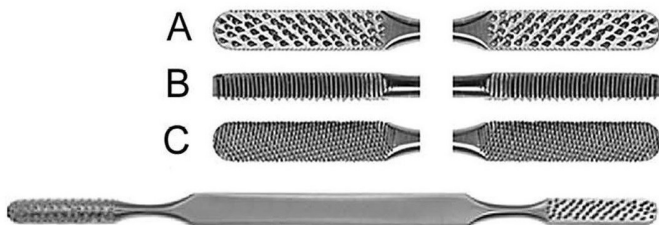

DMI-1981-208

Bone Rasp Fomon 21 cm / 8.5"
8mmX40mm Course Serr 4 Sided Flat / Convex Baldes



DMI-1981-209

Bone Rasp Fomon 21 cm / 8.5"
8mmX40mm Fine Serr 4 Sided Flat / Convex Blades

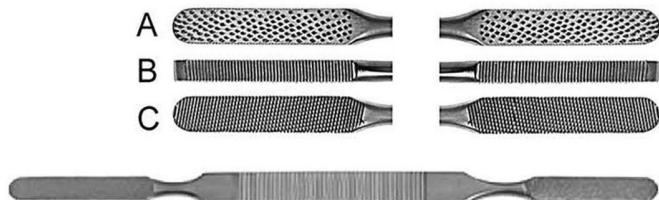

DMI-1981-210

Bone Rasp Kleinert Kurtz 21 cm / 8.5"
8mmX45mm Fine/Coarse Serr 4 Sided Flat / Convex



DMI-1981-211

Bone File / Rasp 21 cm / 8.5"
18mm Fine / Coarse Serr

BONE LEVERS– RETRACTORS

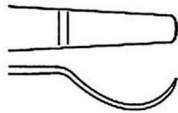

DMI-1981-212
Bone Lever 16 cm / 6 ¼"



DMI-1981-213
Hohman, Mini Bone Lever 16 cm / 6 ¼" 6 mm tip



DMI-1981-214
Hohman, Mini Bone Lever 16 cm / 6 ¼" 8 mm tip

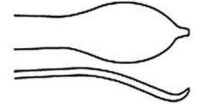

DMI-1981-215
Mini Bone Lever 16cm / 6 ¼" 14 mm tip

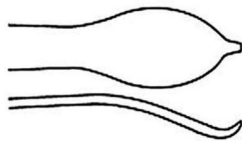
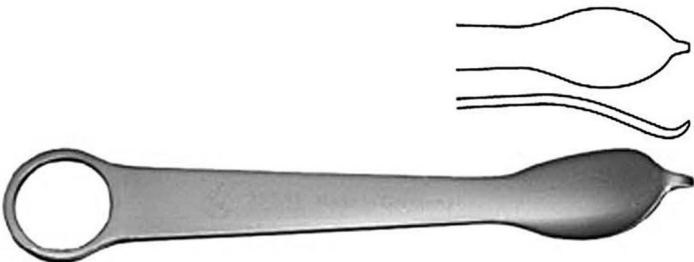

DMI-1981-216
Hohman, Mini Bone Lever 12 cm / 4 ¾" 14 mm tip

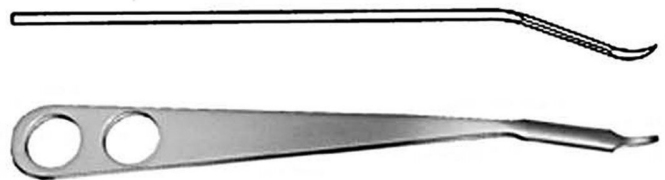

DMI-1981-217
Hohmann Bone Lever 22 cm / 8 ¾" 8 mm Tip narrow tip

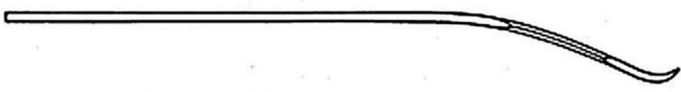
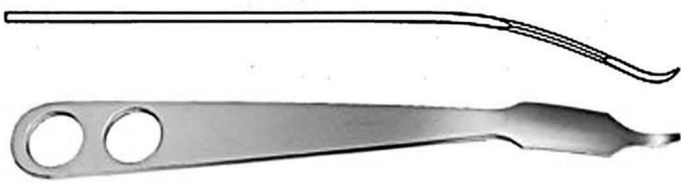

DMI-1981-218
Hohmann Bone Lever 23.5 cm / 9 ¼" 18 mm Tip narrow tip

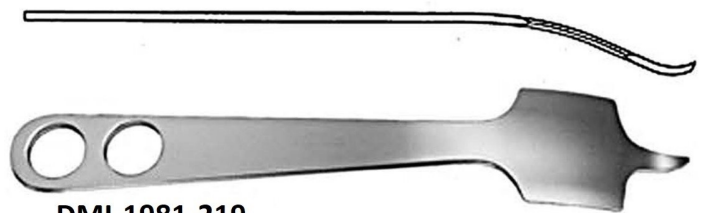

DMI-1981-219
Hohmann Bone Lever 23.5 cm / 9 ¼" 43 mm Tip narrow tip

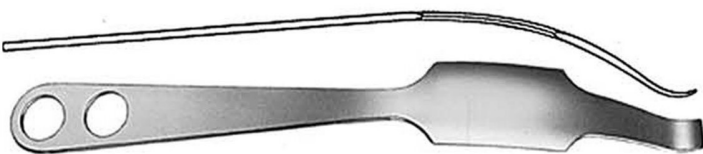

DMI-1981-220
Hohmann Bone Lever 29 cm / 11 ½" 35mm Tip wide tip



DMI-1981-221
Lange-Hohmann Bone Lever 25 cm / 9 ¾" 22mm Tip
Wide tip with groove

BONE LEVERS– RETRACTORS

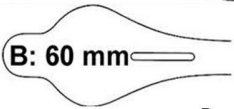
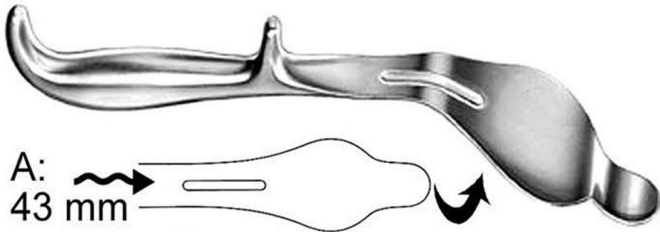

DMI-1981-222

Bennett Bone Lever 24 cm / 9 ½"



DMI-1981-223

Hohmann Bone Lever 27.5 cm / 10 ¾"
24mm Tip wide, round tip



DMI-1981-224

Hohmann Bone Lever 25 cm / 9 ¾" 70 mm Tip narrow tip



DMI-1981-225

Blount Knee Retractor 26.5 cm / 10 ½" blunt



DMI-1981-226

Hohmann Bone Lever 23.5 cm / 9 ¼" 43mm Tip narrow tip



DMI-1981-227

Blount Knee Retractor 26.5 cm / 10 ½"



DMI-1981-228

Hohmann Bone Lever 25.5 cm / 10" 22mm Tip wide tip



DMI-1981-229

Blount Knee Retractor 17.5 cm / 7"

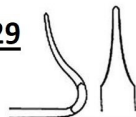

Sizes Available:

- A: 75 X 30 mm
- B: 100 X 30 mm

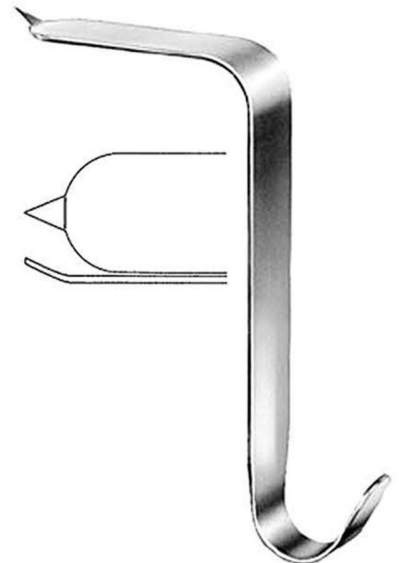

DMI-1981-230

Taylor Spinal
Retractor
16 cm / 6 ¼"
Pointed end

BONE LEVERS- RETRACTORS

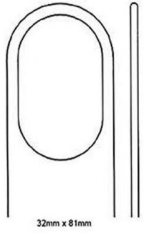

DMI-1981-231

Fukuda Retractor
19 cm / 7 1/2"
T-Handle

A: 32X81mm
B: 38X81mm

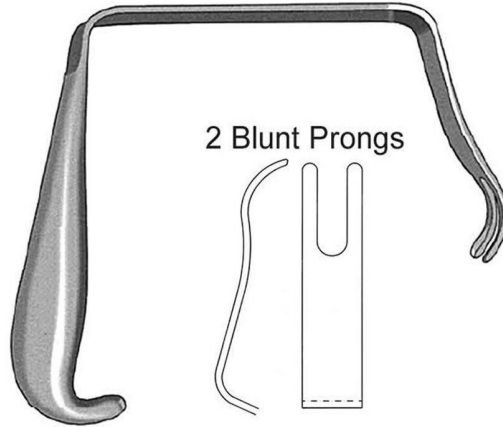

DMI-1981-232

Bristow / Bankart Humeral Retractor
18 cm / 7"



Medium Blade:
57 /69mm Deep
11mm Wide

Large Blade:
63/76mm Deep
11mm Wide

DMI-1981-233

Z Knee Retractor 15 cm / 6"



DMI-1981-234

Deltoid Retractor 28 cm / 11" T Handle w / Ring



DMI-1981-235

Humeral Head Retractor 18 cm / 7" Strong Curved

22 mm Blade
1 Sharp Prong

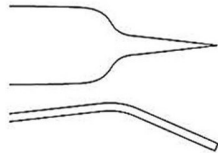

DMI-1981-236

Capsule Retractor 25 cm / 10"

22 mm Blade
2 Sharp Prong

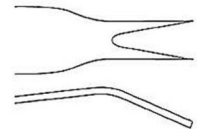

DMI-1981-237

Capsule Retractor 25 cm / 10"

3 Sharp Prongs

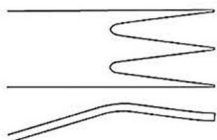

DMI-1981-238

Capsule Retractor 25 cm / 10"

Soft Tissue Retractor
3 Blunt Prong

22mm
Blade

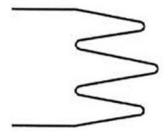

DMI-1981-239

Bristow / Bankart 19 cm / 7 1/2"

BONE LEVERS– RETRACTORS

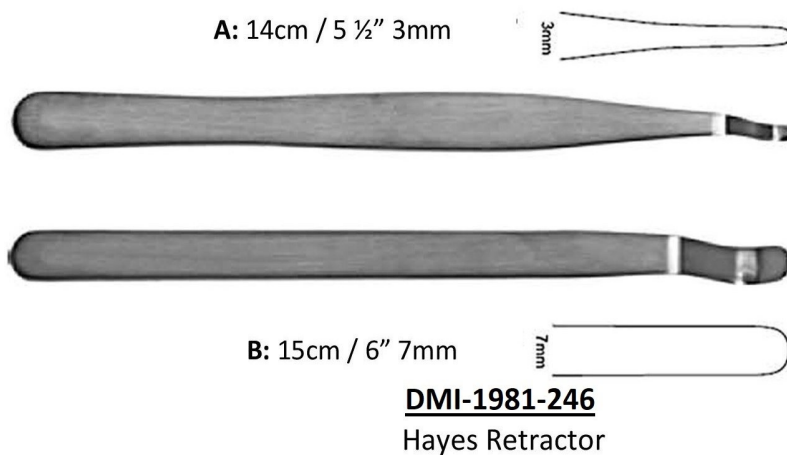
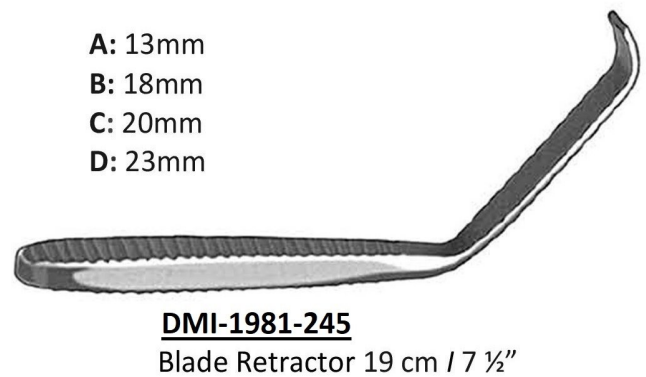
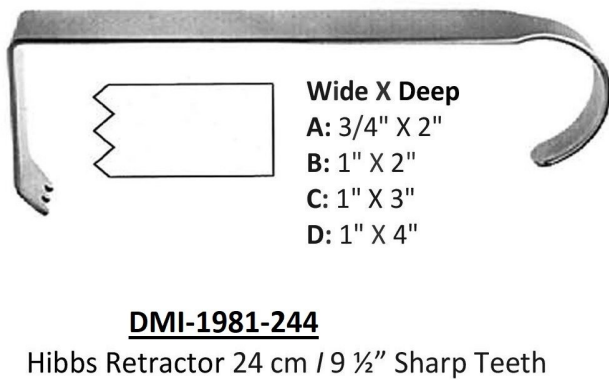
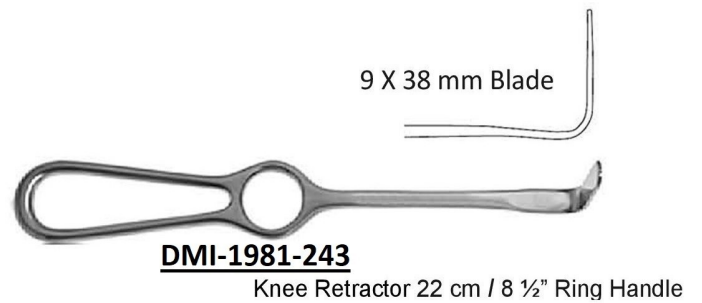
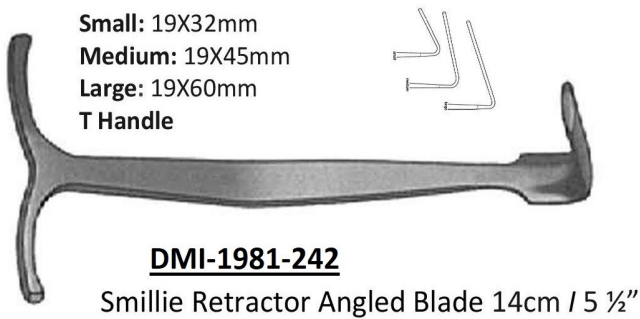
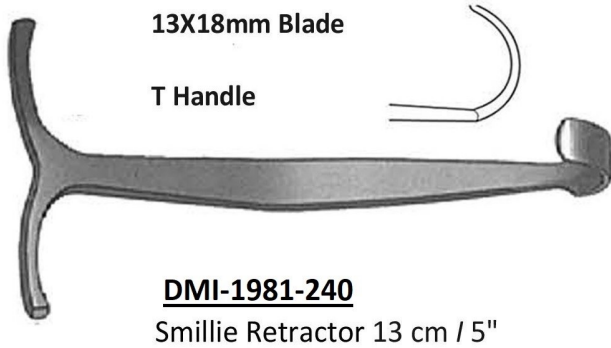

BONE LEVERS– RETRACTORS

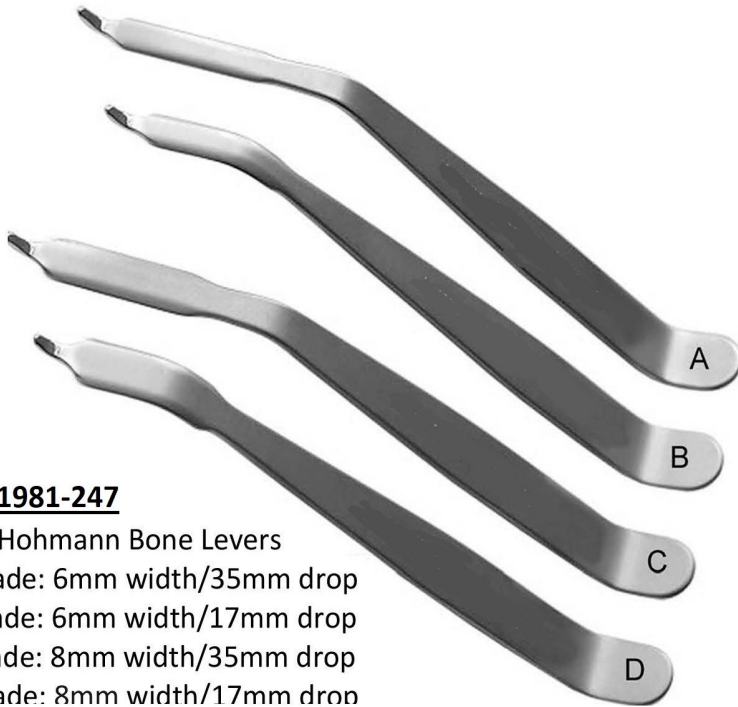

DMI-1981-247

Mini Hohmann Bone Levers

- A:** Blade: 6mm width/35mm drop
- B:** Blade: 6mm width/17mm drop
- C:** Blade: 8mm width/35mm drop
- D:** Blade: 8mm width/17mm drop

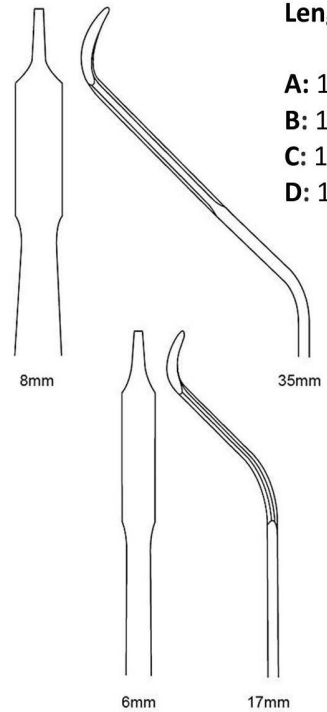

Length:

- A:** 15cm / 6"
- B:** 15.5cm/6 ¼"
- C:** 15cm/6"
- D:** 15.5cm/6 ¼"

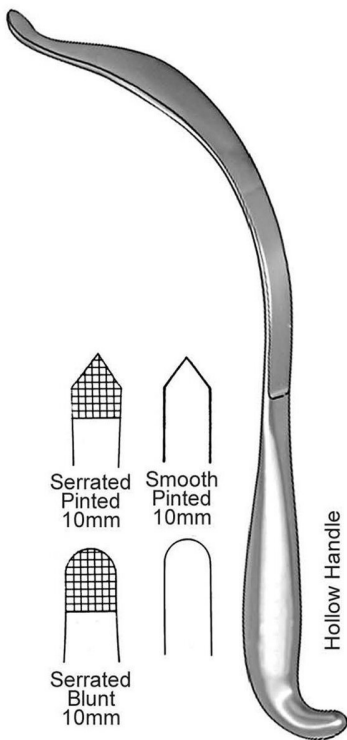

DMI-1981-248

Aufranc Cobra Retractor
26 cm / 10 ½"

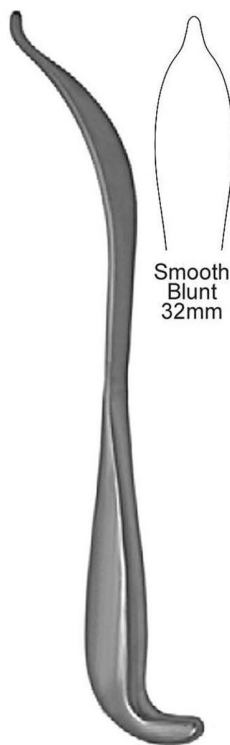

DMI-1981-249

Aufranc Cobra Retractor
27.5cm / 11"

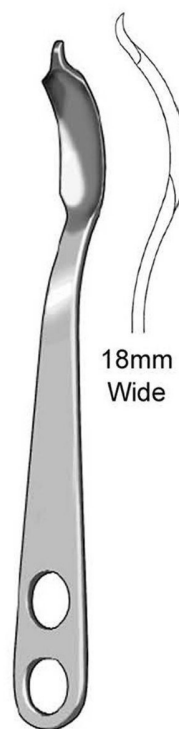

DMI-1981-250

Humeral Head Retractor
23 cm / 9"

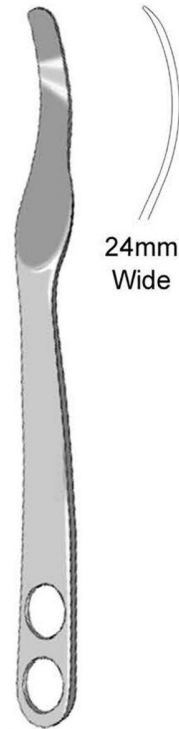

DMI-1981-251

Pelvic Retractor Single Prong
26 cm / 10 ½"

BONE LEVERS- RETRACTORS



DMI-1981-252

Ribbon Retractor Malleable
30 cm / 12"

AVAILABLE SIZES:

- | | | |
|-------------------------|----------------------|----------------------|
| A: 6" X 6mm | G: 8" X 10mm | M: 13" X 38mm |
| B: 6" X 12mm | H: 8" X 12mm | N: 13" X 45mm |
| C: 6" X 16mm | I: 8" X 16mm | O: 13" X 50mm |
| D: 6" X 19mm | J: 8" X 19mm | P: 13" X 65mm |
| E: 7 1/2" X 25mm | K: 13" X 19mm | Q: 13" X 75mm |
| F: 8" X 6mm | L: 13" X 30mm | |



DMI-1981-253

Murphy Bone Skid
30 cm / 12"

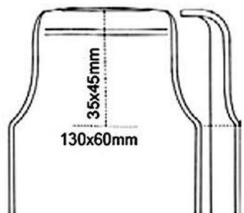

A: 29cm / 11 1/2" With Lip

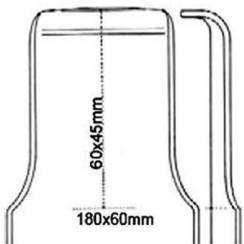

B: 33cm / 13" With Lip

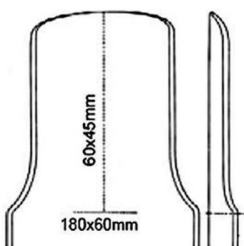

C: 33cm / 13" Without Lip



DMI-1981-254

St. Mark's Pelvic Retractor
Angled Blade

- A:** 22mm Blade
2 Finger Rings Long Round
- B:** 22mm Blade
1 Finger Ring Short Round

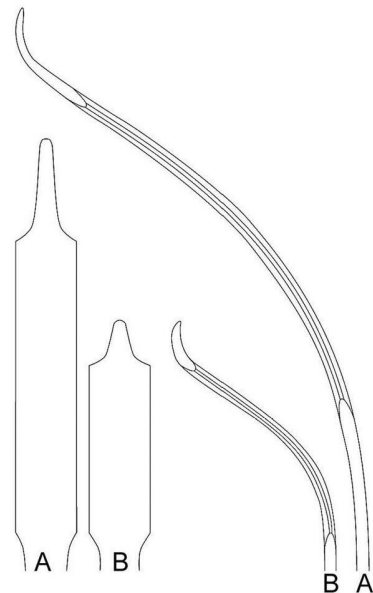
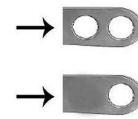

DMI-1981-255

Hohmann Retractor
40cm / 16"



BONE LEVERS– RETRACTORS

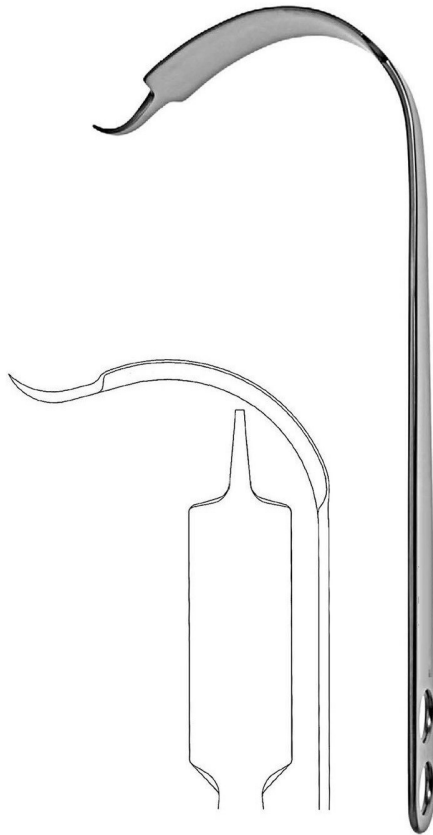

DMI-1981-261

Hohmann Retractor
33 cm / 13"

DMI-1981-256

Buckley Chisel
16cm / 6 ¼"
Octagonal handle

Fig A: 2mm

Fig B: 3mm

Fig C: 4mm

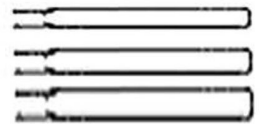

DMI-1981-257

Buckley Gouge
16cm / 6 ¼"
Octagonal handle

Fig A: 2mm

Fig B: 3mm

Fig C: 4mm

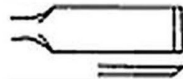
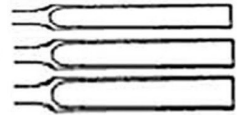

Fig C: 5mm

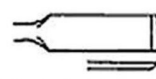

Fig B: 4mm

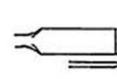

Fig A: 3mm



DMI-1981-258

Stout Bone Chisel 21 cm / 8 ¼" octagonal handle

DMI-1981-259

Bone Chisel 18 cm / 7" Round Handle

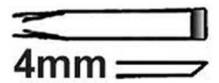

4mm



DMI-1981-260

Bone Chisel 17 cm / 6 ¾" Round Handle

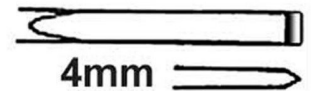

4mm



FIG. A



FIG. B

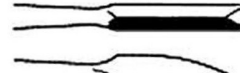

FIG. C



DMI-1981-263

Gardner Bone Chisel 17 cm / 6 ¾" 4 mm



DMI-1981-262

Virchow Skull Breaker
7.5 cm / 3" 40 mm Blade Width

CHISELS- OSTEOTOMES- GOUGES

FIG A: 3 mm

FIG B: 5 mm

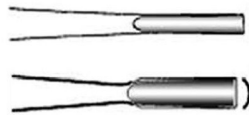

DMI-1981-264

Snyder-O.S.U Bone Chisel 16.5 cm / 6 1/2" 3 mm / 5 mm

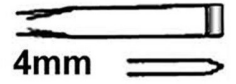

DMI-1981-265

Bone Chisel 18 cm / 7" Octagonal Handle 4 mm

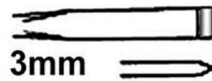

DMI-1981-266

Bone Chisel 18 cm / 7" Octagonal Handle 3 mm



FIG A



FIG B



DMI-1981-267

O.S.U. Bone Chisel 17 cm / 6 3/4" 7 mm / 9 mm

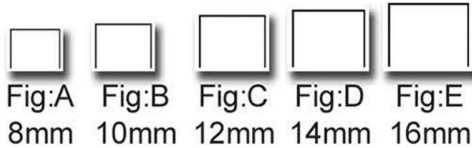

Fig:A 8mm Fig:B 10mm Fig:C 12mm Fig:D 14mm Fig:E 16mm

Side View



DMI-1981-268

Osteotome 13.5 cm / 5 1/4"

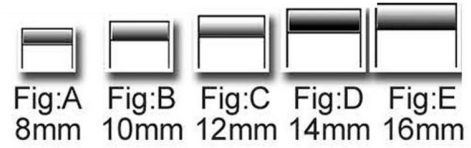

Fig:A 8mm Fig:B 10mm Fig:C 12mm Fig:D 14mm Fig:E 16mm

Side View



DMI-1981-269

Chisel 13.5 cm / 5 1/4"

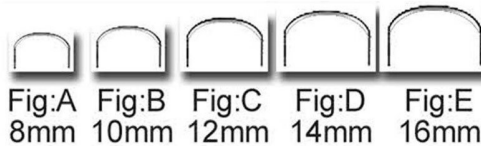

Fig:A 8mm Fig:B 10mm Fig:C 12mm Fig:D 14mm Fig:E 16mm

Side View



DMI-1981-270

Gouge 13.5 cm / 5 1/4"

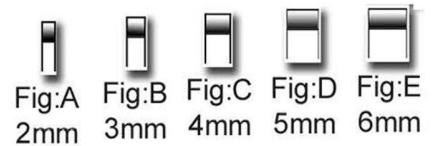

Fig:A 2mm Fig:B 3mm Fig:C 4mm Fig:D 5mm Fig:E 6mm

Side View



DMI-1981-271 Partsch Chisel 13.5 cm / 5 1/4"

DMI-1981-272 Partsch Chisel 17 cm / 6 3/4"

CHISELS- OSTEOTOMES- GOUGES

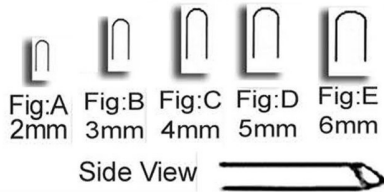

DMI-1981-274 Partsch Gouge 13.5 cm / 5 ¼"

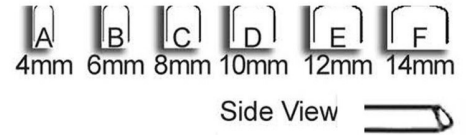

DMI-1981-275
Alexander Gouge 17.5 cm / 7"

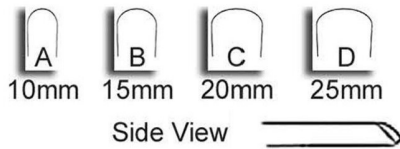

DMI-1981-276 Stille Gouge 20 cm / 8"

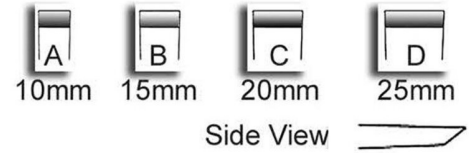

DMI-1981-277 Stille Chisel 20 cm / 8"

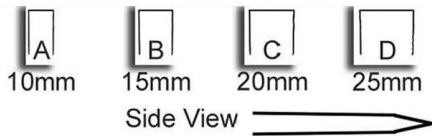

DMI-1981-278
Stille Osteotome 20 cm / 8"

DMI-1981-282

Lambotte, Osteotome
24 cm / 9 ½"
Curved Tip



Available in

15mm
20mm
25mm
30mm
38mm
44mm
50mm

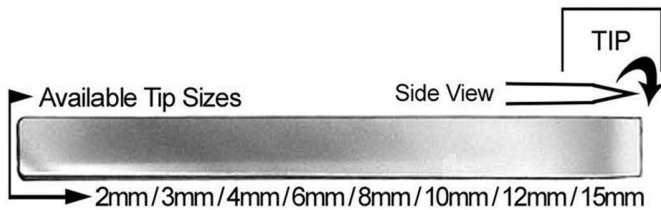

DMI-1981-279 (12.5 cm / 5") Lambotte, Mini Osteotome

DMI-1981-280 (17 cm / 6 ¾") Lambotte, Mini Osteotome
3mm / 4mm / 6mm / 8mm / 10mm / 12mm / 15mm

DMI-1981-281 (24 cm / 9 ½") Lambotte, Osteotome
15mm / 20mm / 25mm / 30mm / 38mm / 44mm / 50mm

CHISELS– OSTEOTOMES– GOUGES

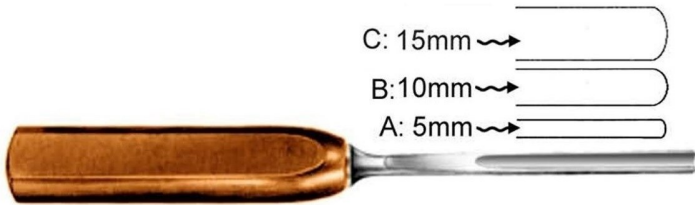

DMI-1981-283

Lexer Spongiosa Gouge (25 cm / 9 ¾")

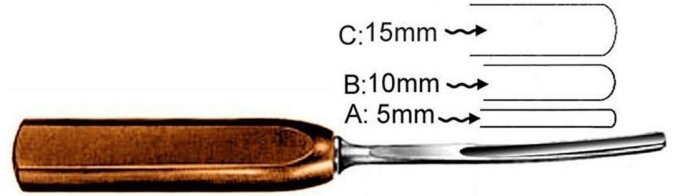

DMI-1981-284

Lexer Spongiosa Gouge (25 cm / 9 ¾")

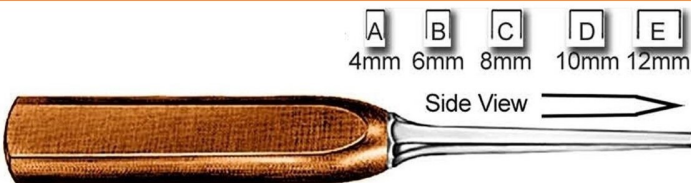

DMI-1981-285

Lexer, Mini Osteotome 18.5 cm / 7 ¼"

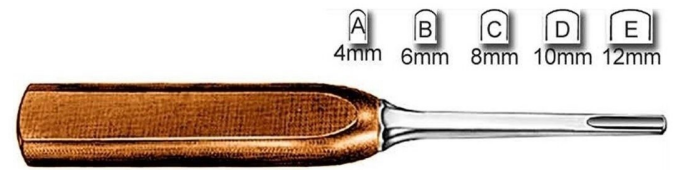

DMI-1981-286

Lexer, Mini Osteotome 18.5 cm / 7 ¼"

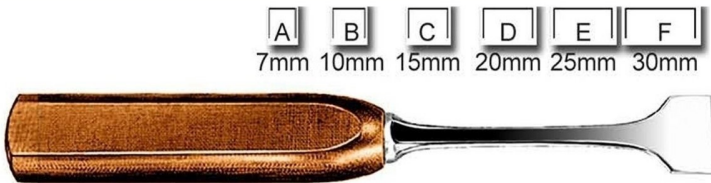

DMI-1981-287

Lexer, Osteotome 22 cm / 8 ¾"

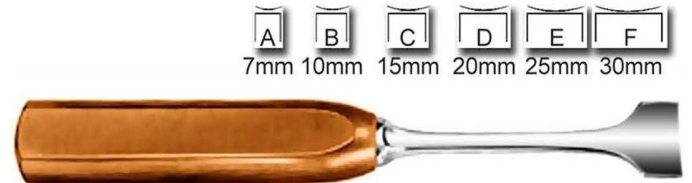

DMI-1981-288

Lexer, Osteotome 22 cm / 8 ¾"



DMI-1981-289

Vickers Spongiosa Gouge 18 cm / 7"

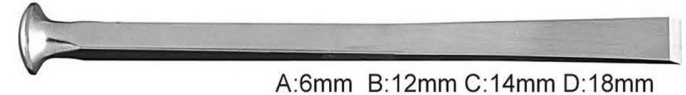

DMI-1981-290

US Army Chisel 18 cm / 7"



DMI-1981-291

US Army Osteotome 18 cm / 7"



DMI-1981-292

US Army Gouge 18 cm / 7"



DMI-1981-293

Smith-Petersen Osteotome 20.5 cm / 8" Straight



DMI-1981-294

Smith-Petersen Osteotome 20.5 cm / 8" Curved

CHISELS- OSTEOTOMES- GOUGES

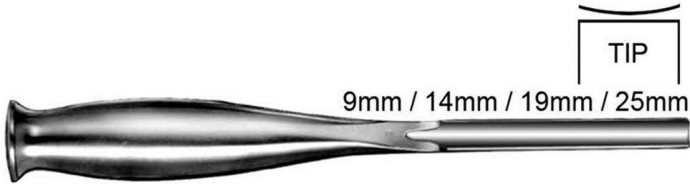

DMI-1981-295

Smith-Petersen Gouge 20.5 cm / 8" Straight Tip

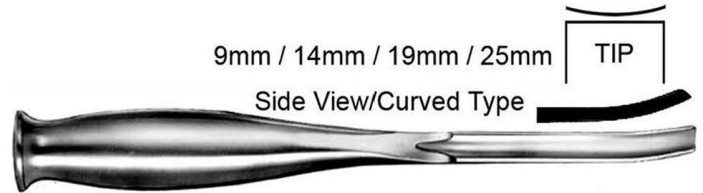

DMI-1981-296

Smith-Petersen Gouge 20.5 cm / 8" Curved Tip

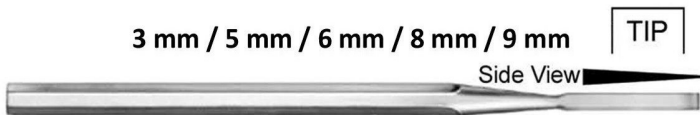

DMI-1981-297

Hook Osteotome 17 cm / 6 3/4"

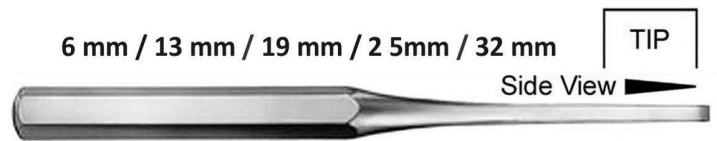

DMI-1981-298

Hibbs Osteotome 24.5 cm / 9 3/4"

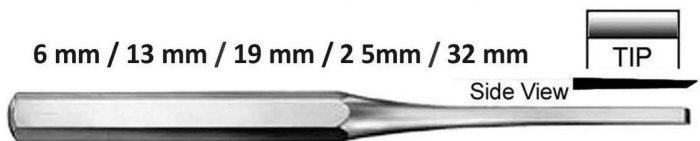

DMI-1981-299

Hibbs Chisel 24.5 cm / 9 3/4"



DMI-1981-300

Hibbs Gouge 24.5 cm / 9 3/4"

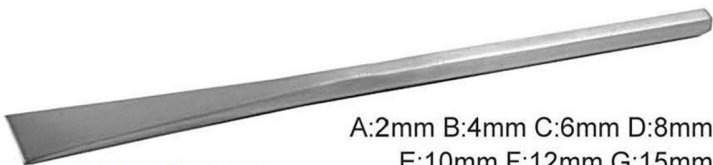

DMI-1981-301

Sheehan Osteotome 16cm / 6 1/2"



DMI-1981-302

Silver Osteotome 18 cm / 7" Straight



DMI-1981-303

Silver Osteotome 18 cm / 7" Curved Right



DMI-1981-304

Silver Osteotome 18 cm / 7" Curved Left



DMI-1981-305

Shoulder Penetrating Gouge 21 cm / 8 1/2"

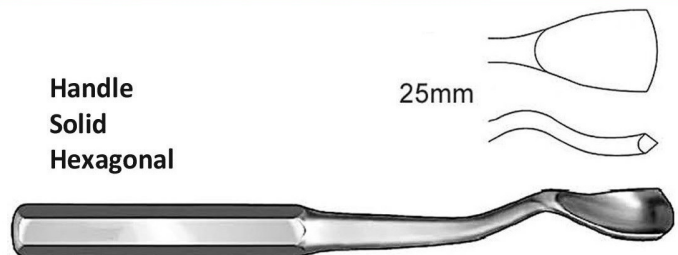

DMI-1981-306

Swan Neck Gouge 23 cm / 9"

CHISELS- OSTEOTOMES- GOUGES

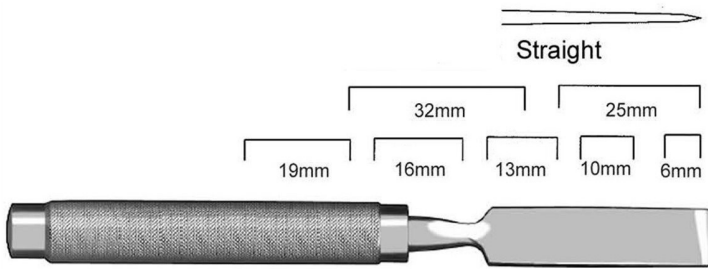

DMI-1981-307

Cobb Osteotome 28 cm / 11" Straight

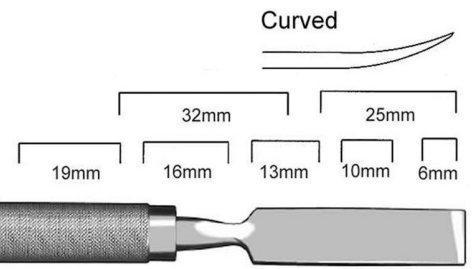

DMI-1981-308

Cobb Osteotome 28 cm / 11" Curved

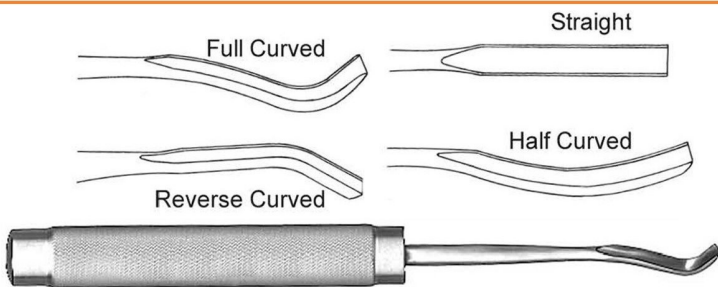

DMI-1981-309

Cobb Gouge 28 cm / 11"



DMI-1981-310

Lexier Osteotome Angled / 28 cm / 11"

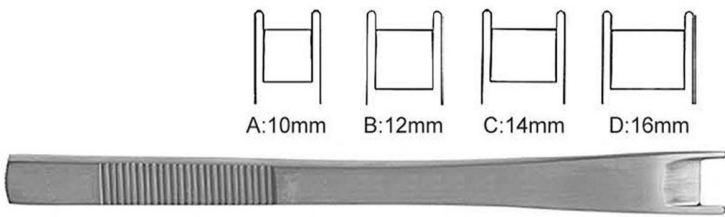

DMI-1981-311

Cinelli Osteotome 15.5 cm / 6 1/2"

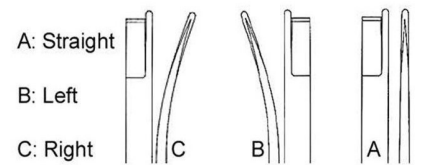

DMI-1981-312

Anderson Neivert Osteotome 20 cm / 8"

DMI-1981-313

Hibbs Osteotome 47 cm / 18 1/2" 10 mm Tip
3 1/2" Tip L / 10 3/4" Shaft L / 4 1/4" Handle L
11 .5 mm Shaft Diameter

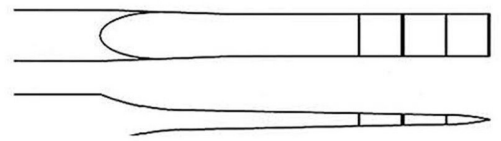

DMI-1981-314

Hibbs Gouge 47 cm / 18 1/2" 10 mm Tip
3 1/2" Tip L / 10 3/4" Shaft L / 4 1/4" Handle L
11 .5 mm Shaft Diameter

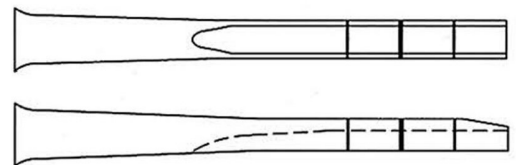

CHISELS- OSTEOTOMES- GOUGES



DMI-1981-315
Spinal Fusion Gouge 24 cm / 9 1/2" 6 mm Tip

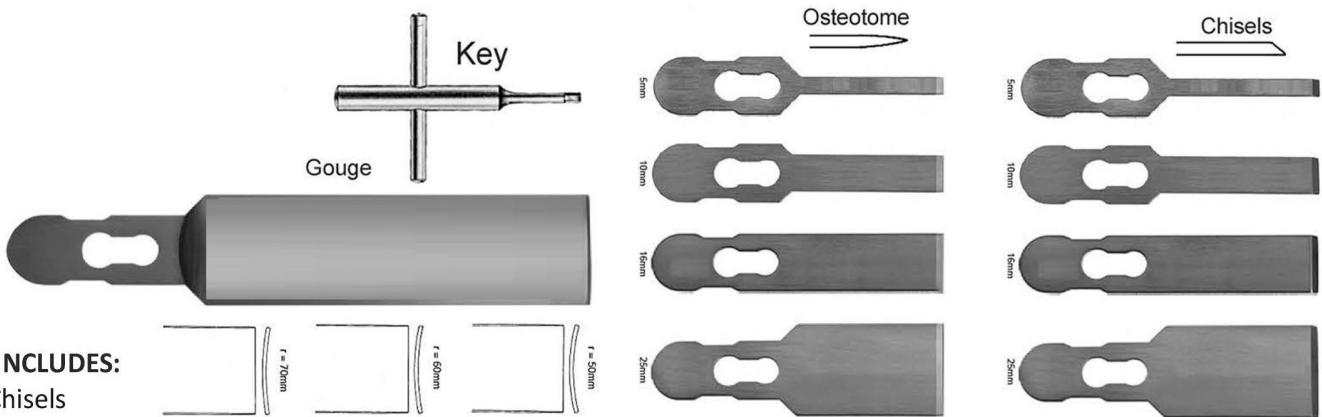

- SET INCLUDES:**
 5 x Chisels
 5/1 0/15/25mm
 5 x Osteotomes
 5/1 0/15/25mm
 3 x Gouges
 50/60/70mm Radius
 1 x Handle Fibre
 1 x Key

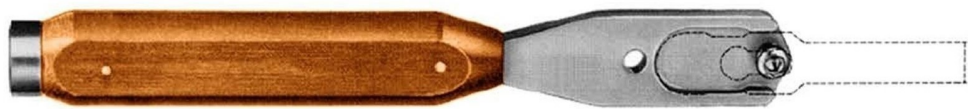

DMI-1981-316
Chisel Handle Fibre w/Chisel-Osteotome-Gouge Blades 18.5 cm / 7 1/4"

Available Sizes: □0000 □000 □00 □0 1 2 3 4 5 6



DMI-1981-317
Volkman Bone Curette 18.5 cm / 7 1/4" oval with plastic handle

0 1 2 3 4



DMI-1981-318
Volkman Bone Curette 27.5 cm / 10 3/4" oval with plastic handle

BONE CURETTES

A: 13 cm / 5"
B: 16 cm / 6 1/4"
C: 20 cm / 8"

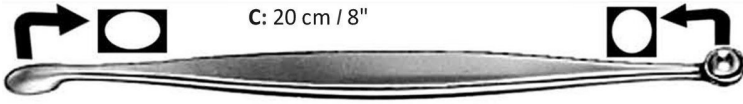

DMI-1981-319

Volkman Bone Curette, double-ended (oval / round)



DMI-1981-320

Bone Curette, double-ended (round / oval) 21 cm / 8 1/4"



DMI-1981-321

Schede Bone Curette 17 cm / 6 3/4" oval with hollow handle

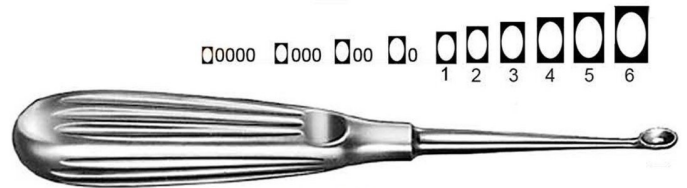

DMI-1981-322

Volkman Bone Curette 17 cm / 6 3/4" oval, with hollow

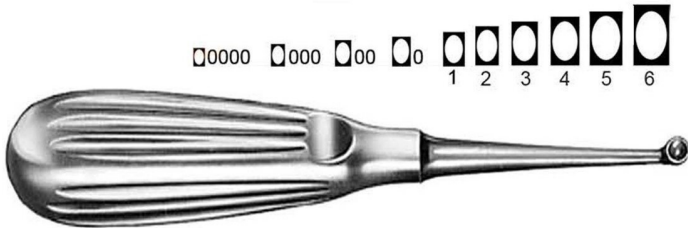

DMI-1981-323

Bruns Bone Curette 17 cm / 6 3/4" Round, with hollow handle

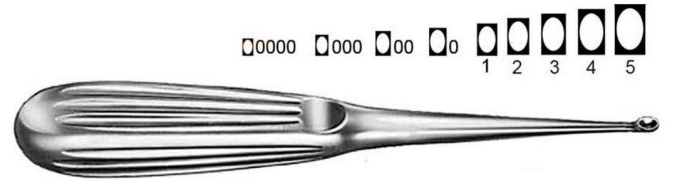

DMI-1981-324

Spratt Bone Curette 17 cm / 6 3/4" Oval, with hollow handle

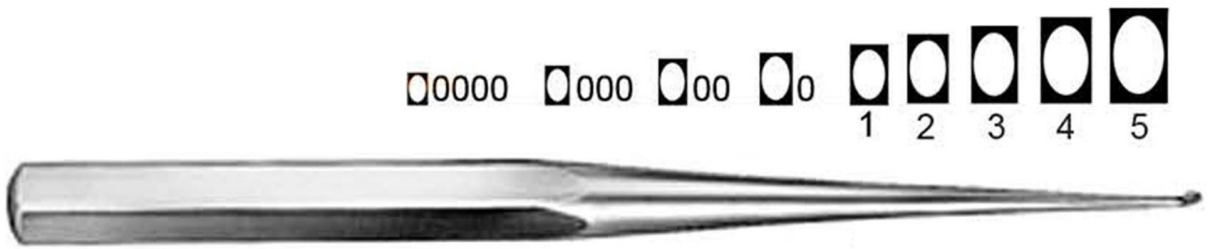

DMI-1981-325

Bruns Bone Curette 23 cm / 9" oval, solid



DMI-1981-326

Scoville Bone Curette 25 cm / 9 3/4" oval, with hollow handle

BONE CURETTES



DMI-1981-327

Simon Bone Curette 25 cm / 9 $\frac{3}{4}$ " oval, with hollow handle



DMI-1981-328

Modell USA Bone Curette 16 cm / 6 $\frac{1}{4}$ " Oval, with hollow handle



DMI-1981-329

Modell USA Bone Curette 15.5 cm / 6" Oval, with hollow handle



DMI-1981-330

Model USA Bone Curette 15.5 cm / 6" Oval, with hollow handle

BONE CURETTES



DMI-1981-331

Halle Bone Curette 21 cm / 8 1/4" oval, malleable shaft, with hollow handle

A: 00/0 ●/● B: 0/1 ●/● C: 1/2 ●/●



Available in 3 sets of combination

DMI-1981-332

Williger Bone Curette, double-ended 13.5 cm / 5 1/4" handle



A: 00/00 ●/● B: 0/0 ●/● C: 1/1 ●/●

DMI-1981-333

Williger Bone Curette, 17 cm / 6 3/4" double-ended oval / oval



A: 12.5 cm / 5"
B: 14.5 cm / 5 3/4"
C: 17 cm / 6 3/4"

DMI-1981-334

Volkmann Bone Curette, double-ended

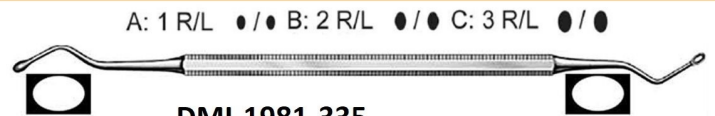

A: 1 R/L ●/● B: 2 R/L ●/● C: 3 R/L ●/●

DMI-1981-335

Hemingway-Martin Bone Curette, double-ended
18.5 cm / 7 1/4"

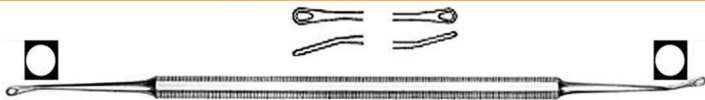

DMI-1981-336

Bone Curette, 17.5 cm / 7" double-ended round

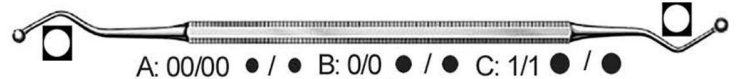

A: 00/00 ●/● B: 0/0 ●/● C: 1/1 ●/●

DMI-1981-337

Hemingway Bone Curette, double-ended, round / round
18.5 cm / 7 1/4" octagonal handle

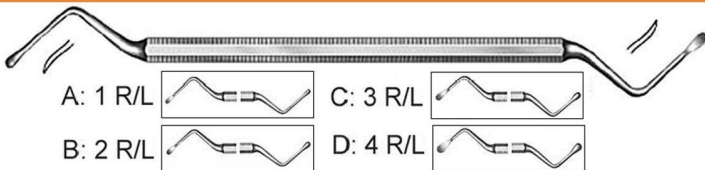

A: 1 R/L C: 3 R/L
B: 2 R/L D: 4 R/L

DMI-1981-338

Lucas Bone Curette, double-ended 18 cm / 7"
Octagonal handle

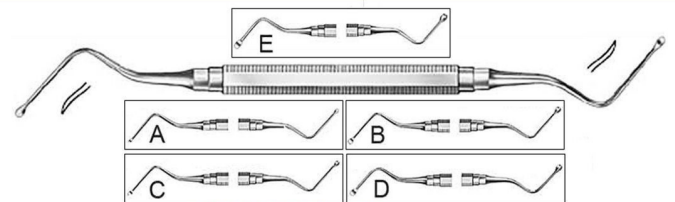

DMI-1981-339

Miller-Colburn Bone Curette, double-ended 17 cm / 6 3/4"

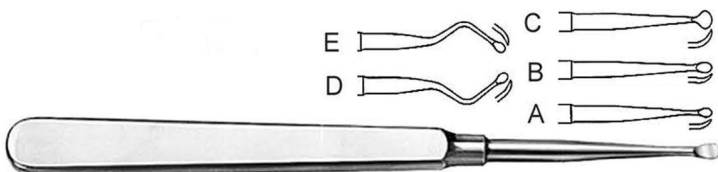

DMI-1981-340

Molt Bone Curette 17 cm / 6 3/4"



DMI-1981-341

Molt Bone Curette 19 cm / 7 1/2" Round Handle

BONE CURETTES

**Hollow Handle
Oval Fenestrated
4X7mm Cup
Sharp/Blunt**

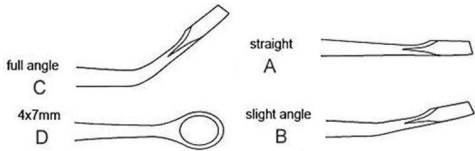

DMI-1981-342

Semmes Ring Curette 23 cm / 9"

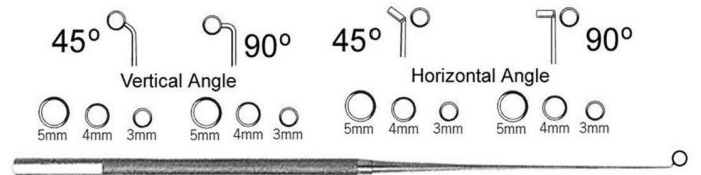

DMI-1981-343

Ray Pituitary Curette 18 cm / 7 1/2"

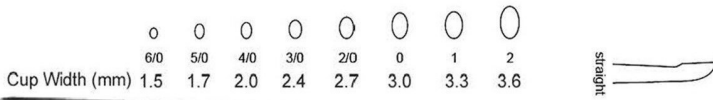

DMI-1981-344

Lempert Curette 18 cm / 7 1/2"

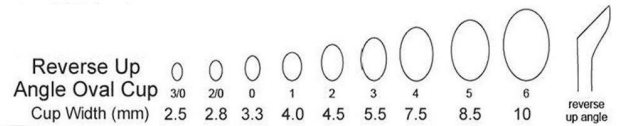

DMI-1981-345

Epstein Curette 18 cm / 7 1/2"

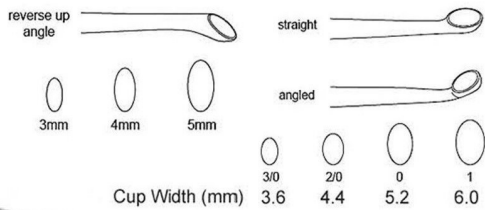

DMI-1981-346

Bushe Curette 25 cm / 10"

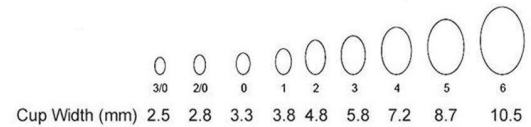

DMI-1981-347

Spinal Fusion Curette 28 cm / 11"

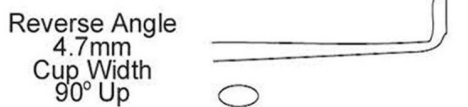

DMI-1981-349

Scoville Curette 25 cm / 10"



DMI-1981-350

Ring Curette

A: 25 cm / 10" #0 6mm Cup D: 28 cm / 11 1/2" #0 6mm Cup
B: 25 cm / 10" #2 8mm Cup E: 28 cm / 11 1/2" #2 8mm Cup
C: 26 cm / 10 1/2" #6 14mm Cup F: 30 cm / 12 1/2" #6 14mm Cup

BONE CURETTES

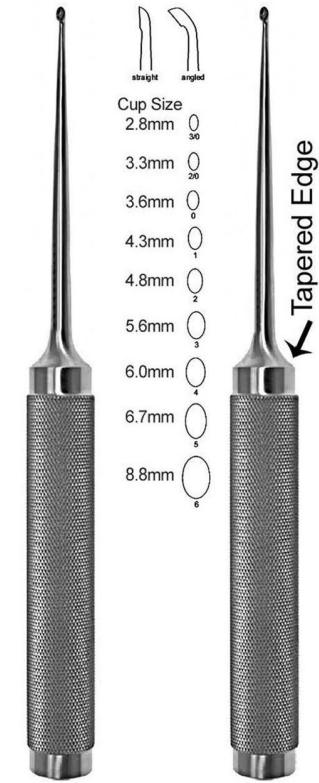

Hollow Handle Solid Handle
DMI-1981-351
 Cobb Curette Oval Cups
 28 cm / 11"

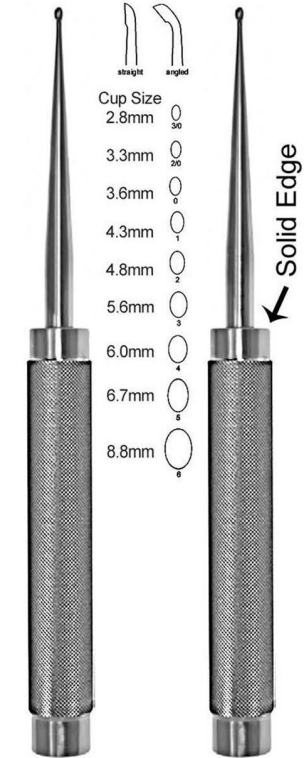

Hollow Handle Solid Handle
DMI-1981-352
 Cobb Curette Oval Cups
 28 cm / 11"

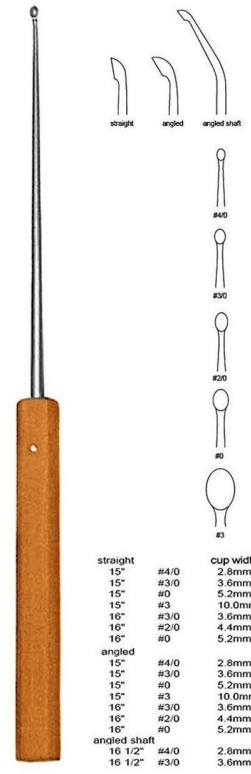

DMI-1981-353
 Syptert Curette Long
 Delicate Shaft



Knurled Aluminum Handle
DMI-1981-354
 Cone Ring Curette
 23 cm / 9"

- A: Straight 8mm Sharp/Blunt
- B: Straight 11 mm Sharp/Blunt
- C: Angled 8mm Sharp/Sharp
- D: Angled 11 mm Sharp/Sharp
- E: Angled 8mm Sharp/Sharp Right Cvd

- F: Angled 11 mm Sharp/Sharp Right Cvd
- G: Angled 8mm Sharp/Sharp Left Cvd
- H: Angled 11 mm Sharp/Sharp Left Cvd

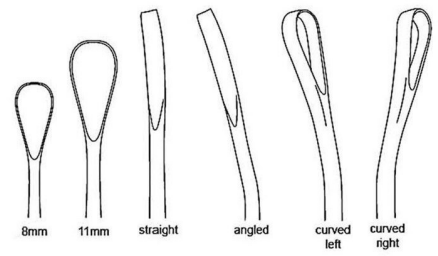

DMI-1981-355
 Zielke Ring Curette 34 cm / 13 1/2" TEFLON Handle

17" Angled 40° 3mm Diameter 2.7"
 Tip Length Cone Ring Curette
 Endoscopic Fibre Handle 9.3" Shaft
 Length 5" Handle Length .285 (7
 .2mm) Shaft Diameter

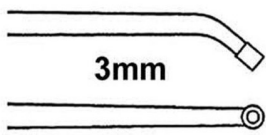

20" Angled 30°
 6mm Diameter
 3 1/2" Tip Length
 10" Shaft Length
 6 1/2" Handle Length
 45" (11 .5mm)
 Shaft Diameter

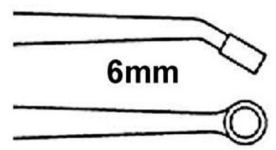

DMI-1981-356
 Cone Ring Curette Endoscopic Fibre Handle

BONE CURETTES

17" Reverse Angled 40° 3mm x 6mm cup
2.7" Tip Length 9.3" Shaft Length 5" Handle
Length.285 (7.2mm) Shaft Diameter

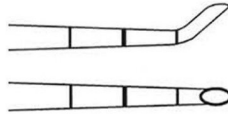

20" Reverse Angled 30°
6mm x 9mm cup 3 1/2"
Tip Length 10" Shaft
Length 6 1/2" Handle
Length .45 (7.2mm)
Shaft Diameter

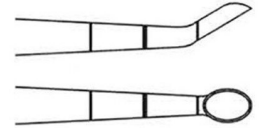

DMI-1981-357

Epstein Curette Endoscopic Fibre Handle

A: 17cm / 6 3/4" 8mm | B: 19cm / 7 1/2" 16 mm | E: 18.5cm / 7" 12 mm
C: 19cm / 7 1/2" 16 mm | D: 18.5cm / 7 1/4" 12 mm

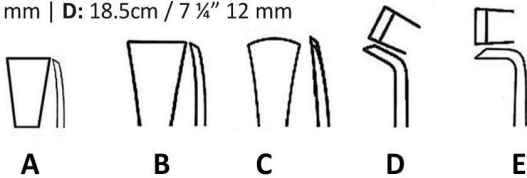

DMI-1981-358

Martin-Langenbeck Periosteal Elevator (Solid)

B: 18.5cm / 7 1/4" 15mm tip

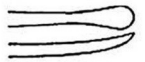
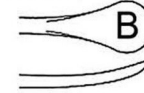
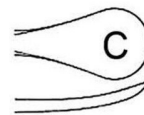

C: 19cm / 7 1/2" 20 mm tip

A: 16cm / 6 1/4" 7mm



DMI-1981-359

Martin-Langenbeck Periosteal Elevator (Solid)

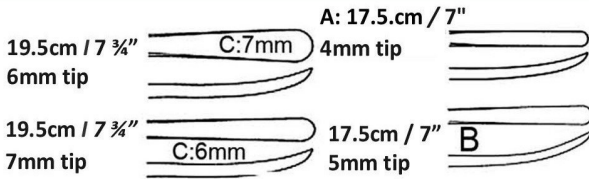

DMI-1981-360

Martin-Langenbeck Periosteal Elevator (Solid)



DMI-1981-361

Langenbeck Periosteal Elevator 18.5 cm / 7 1/4"
With hollow handle



DMI-1981-362

Langenbeck Periosteal Elevator 19.5 cm / 7 3/4"
With hollow handle



DMI-1981-363

Periosteal Elevator 16 cm / 6 1/4" Delicate, solid

HEAD OFFICE

Shad Colony, Roras Road,
Sialkot 51310 - Pakistan

Cell: +92-300-6126898

Ph: +92-52-3558686

Fax: +92-52-3558686

info@demaanz.com

www.demaanz.com

PERIOSTEAL ELEVATORS

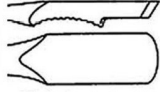

DMI-1981-364

Farabeuf Periosteal Elevator 15 cm / 6"
With hollow handle

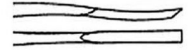

DMI-1981-365

Periosteal Elevator 3mm Tip 18 cm / 7"
Extra narrow, with plastic handle



DMI-1981-366

Kahre-Williger 16 cm / 6 1/4"
Periosteal Elevator solid

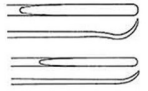

DMI-1981-367

Kahre-Williger Periosteal Elevator solid
16cm / 6 1/4"

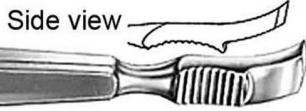

DMI-1981-368

Farabeuf Periosteal Elevator
15 cm / 6" with hollow handle

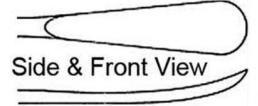

DMI-1981-369

Sedillot Periosteal Elevator 22 cm / 8 3/4" (15mm tip)

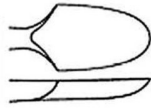

DMI-1981-370

Periosteal Elevator 20 cm / 8" (14 mm Tip)
With plastic handle



DMI-1981-371

Periosteal Elevator 19 cm / 7 1/2"
(14 mm Tip) with plastic handle

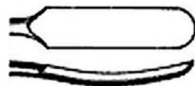

DMI-1981-372

Periosteal Elevator 6mm Tip
18 cm / 7" narrow, plastic handle



DMI-1981-373

Periosteal Elevator 18 cm / 7" narrow,
Plastic handle (6mm Tip)

PERIOSTEAL ELEVATORS— DISSECTORS



DMI-1981-374

Williger Periosteal Elevator
12.5 cm / 5" solid 5mm Tip



DMI-1981-375

Periosteal Elevator,
Double ended 17.5 cm / 7"

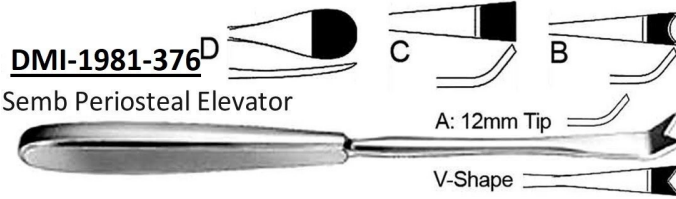

DMI-1981-376^D
Semb Periosteal Elevator

A: 12mm Tip

V-Shape

A+D: 21cm / 8 ¼" & B+C: 18.5 cm / 7 ¼"

A: V-shape 12mm | B: Inside round 12mm

C: Straight 13mm | D: Outer round 15mm

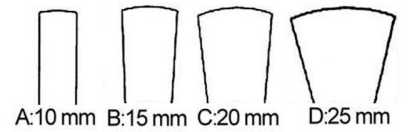

DMI-1981-377

Lambotte Periosteal Elevator 21.5 cm / 8 ½"



DMI-1981-378

Periosteal Elevator 20 cm / 8" with plastic handle



DMI-1981-379

Periosteal Elevator 17 cm / 6 ¾" with hollow handle

Right curved for adults Left curved for adults Right curved for Childrens Light curved for Childrens



DMI-1981-380

Doyen Rib Raspatory 17.5 cm / 7" Rib Raspatories with hollow handle

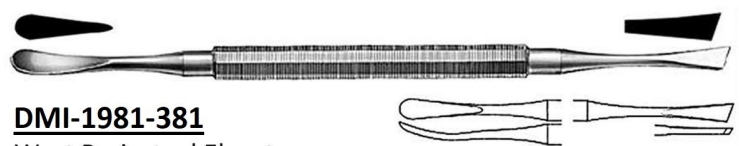

DMI-1981-381

West Periosteal Elevator,
Double-ended 18.5 cm / 7 ¼" octagonal handle

DMI-1981-382

Williger Elevator
17 cm / 6 ¾" 7mm tip



DMI-1981-384

Elevator 17 cm / 6 ¾" Light weight



DMI-1981-383

Williger Elevator
16 cm / 6 ¼" (5.5mm tip)

PERIOSTEAL ELEVATORS- DISSECTORS

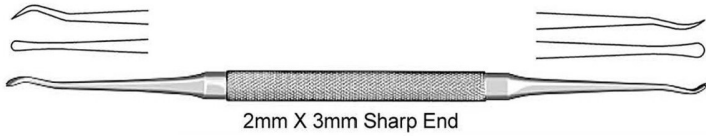

DMI-1981-385

Kleinert Kutz Elevator 14 cm / 5 1/2"



DMI-1981-386

Vickers Dissector 17 cm / 6 3/4"

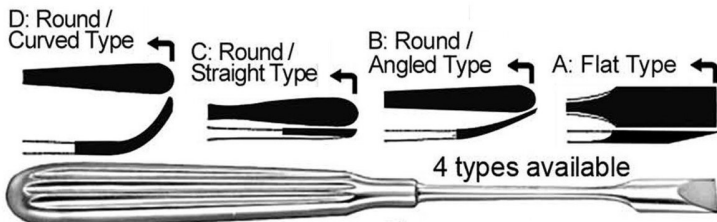

DMI-1981-387

Adson Elevator 17.5 cm / 7" A/B/C/D

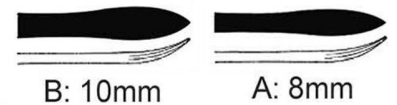

DMI-1981-388

Langenbeck Elevator 19.5 cm / 7 3/4" A/B

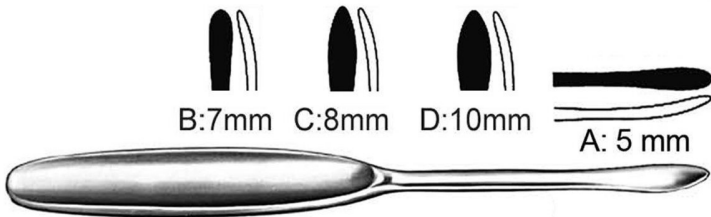

DMI-1981-389

Martin Langenbeck Elevator 17 cm / 6 3/4" A/B/C | D: 19.5 cm / 7 3/4"



DMI-1981-390

Phalangeal Elevator 16cm / 6 1/4"



DMI-1981-391

Alderdyce Dissector, double-ended 21 cm / 8 1/4"

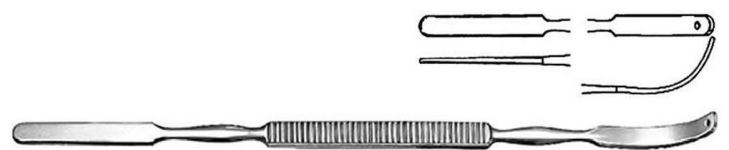

DMI-1981-392

McDonald Dissector, double-ended 18.5 cm / 7 1/4"



DMI-1981-393

Freer Elevator 19 cm / 7 1/2"



DMI-1981-394

Penfield Elevator Endoscopic 38 cm / 15" 5mm Semi Sharp / 1X10mm Blunt Hook



DMI-1981-395

Smithwick Hook and Dissector 30 cm / 12" 5mm Semi Sharp / 1X10mm Blunt Hook

PERIOSTEAL ELEVATORS– DISSECTORS

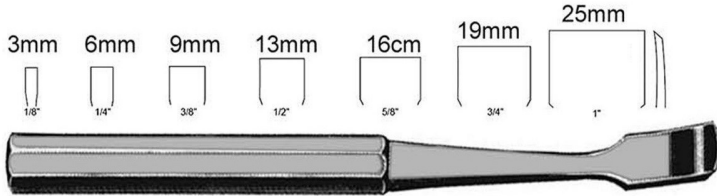

DMI-1981-396

Key Elevator 19 cm / 7 1/2" Sharp Edge

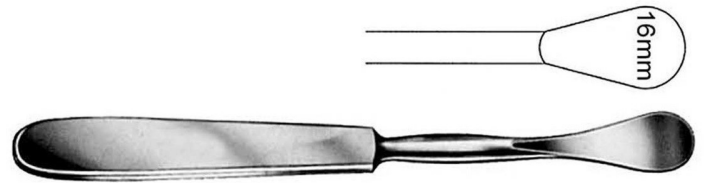

DMI-1981-397

Sedilot Elevator 18 cm / 7" Sharp Edge



DMI-1981-398

Alexander Periosteal Respiratory 20 cm / 8" / 12mm Sharp

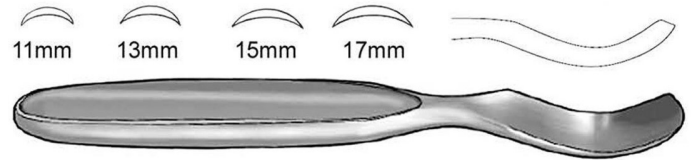

DMI-1981-399

MeGiamry Metatarsal Elevator 16 cm / 6 1/2" Sharp

- A: 19cm / 7 1/2" 13mm
- B: 20cm / 8" 19mm
- C: 23cm / 9" 25mm
- D: 25.5cm / 10" 30mm

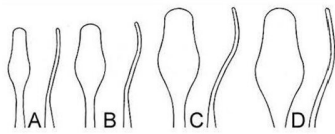

DMI-1981-400

Chandler Elevator Blunt



DMI-1981-401

Sayre Elevator 16 cm / 6 1/2"

A: Sharp / Blunt B: Blunt/ Blunt

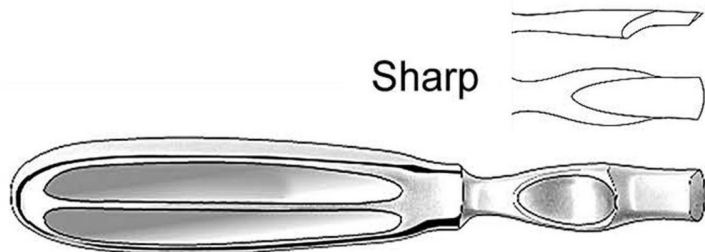

DMI-1981-402

Kirmission Periosteal Respiratory 17 cm / 6 3/4"

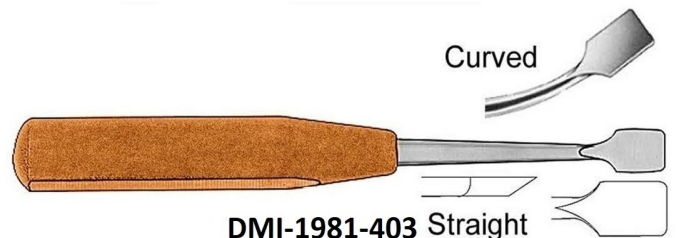

DMI-1981-403

Periosteal Elevator 17cm / 6 3/4" Fibre Handle

13mm Blade Sharp

- A: 14mm Full Curves
- B: 14mm Slight Curves
- C: 7mm Full Curves
- D: 7mm Slight Curves

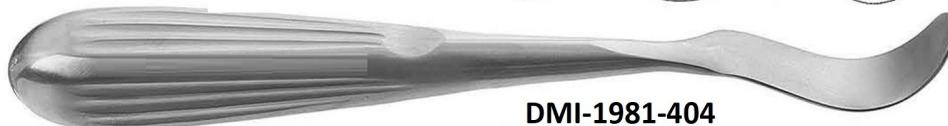
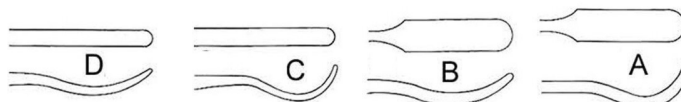

DMI-1981-404

Crego Periosteal Elevator 19 cm / 7 3/4" Sharp

PERIOSTEAL ELEVATORS- DISSECTORS

Small

A: 26 cm / 10 1/4" 13mm Width at Tip

Medium

B: 26 cm / 10 1/4" 20mm Width at Tip

Large

C: 35 cm / 13 3/4" 25mm Width at Tip

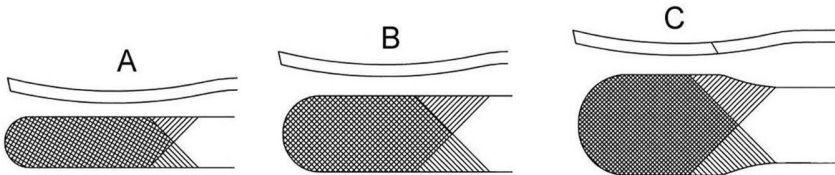

DMI-1981-405

Darraeh Elevator Blunt

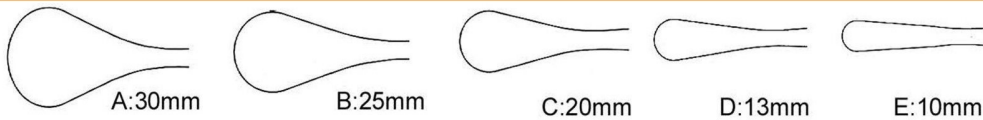

DMI-1981-406

Cobb Spinal Elevator Sharp 24cm / 9 1/2" Hexa Handle

ALSO AVAILABLE WITH FIBRE HANDLE

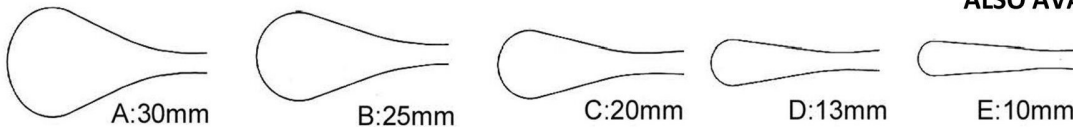

DMI-1981-407

Spinal Elevator Sharp 28 cm / 11" Knurled Handle

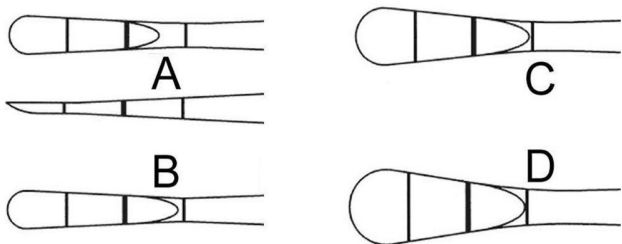

A: 43cm / 17"
6mm Tip Width
2.7" Tip Length
9.3" Shaft Length
5" Handle Length
7.2mm Shaft Dia

B: 50cm / 20"
6mm Tip Width
3 1/2" Tip Length
10" Shaft Length
6 1/2" Handle L
11.5mm Shaft Dia

C: 50cm / 20"
10mm Tip Width
3 1/2" Tip Length
10" Shaft Length
6 1/2" Handle L
11.5mm Shaft Dia

D: 50cm / 20"
13mm Tip Width
3 1/2" Tip Length
10" Shaft Length
6 1/2" Handle L
11.5mm Shaft Dia



DMI-1981-408

Cobb Elevator Endoscopic Sharp / Fibre Handle

ELEVATORS SPINAL S/S SPINAL

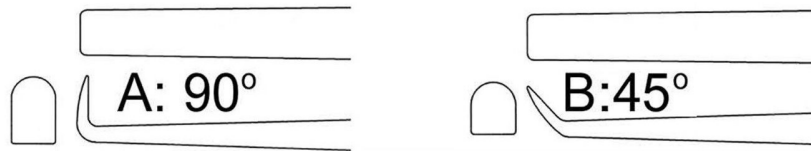

43 cm / 17" - 9mm Tip Radius - 4" Tip Length
8" Shaft Length - 5" Handle Length
11 .5mm Shaft Diameter



DMI-1981-409

Rib Elevator Endoscopic Sharp / Fibre Handle

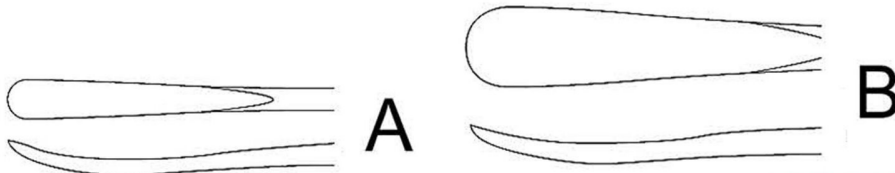

A: 8mm Wide
B: 17mm Wide



DMI-1981-410

Wagner Elevator Sharp / Fibre Handle 33 cm / 13"

A: 19mm ø / 230 gms
B: 25mm ø / 260 gms

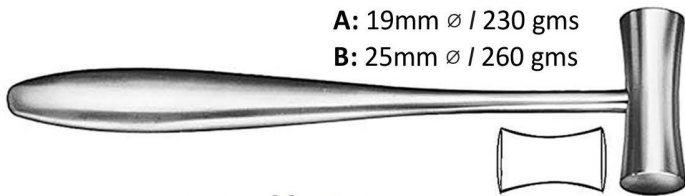

DMI-1981-411

Lucae Mallet 19.5 cm / 7 ¾"



DMI-1981-412

Cottle Mallet Plane / Convex
19 cm / 7 ½" 30mm ø / 300 gms

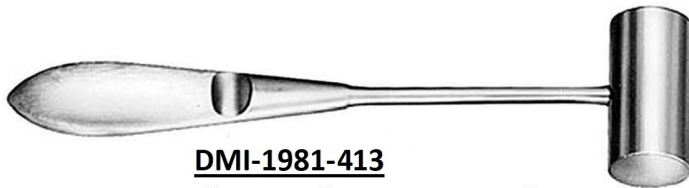

DMI-1981-413

Williger Mallet 16.4cm / 6 ½"
20 mm ø / 140 gms



DMI-1981-414

Mallet 26 cm / 10 ¼"
30 mm ø / 510 gms

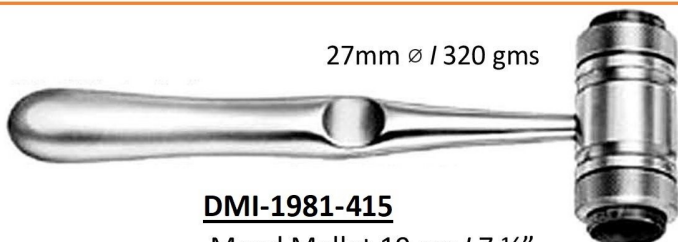

27mm ø / 320 gms

DMI-1981-415

Mead Mallet 19 cm / 7 ½"
With interchangeable plastic disks



DMI-1981-416

Partsch Mallet 19 cm / 7 ½"
With hollow handle 22mm ø / 200 gms

ORTHOPEDIC MALLETS S/S & FIBER



DMI-1981-417

Mallet 26 cm / 10 ¼" with lead filling
42mm ø / 400 gms



DMI-1981-418

Mallet 26 cm / 10 ¼" without lead filling
42mm ø / 400 gms

- A: 26mm ø / 300 gms
- B: 28mm ø / 340 gms
- C: 30mm ø / 400 gms

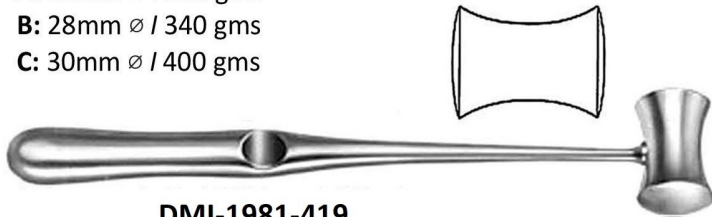

DMI-1981-419

Williger Mallet 24 cm / 9 ½" lead filled
42mm ø / 400 gms



DMI-1981-419

Mallet 30 mm ø / 675 gms
26.5 cm / 10 ½" plane (Teflon) / convex (steel)



DMI-1981-420

Mallet 26 cm / 10 ¼"
42 / 30mm ø / 530 gms



DMI-1981-421

Mallet 24 cm / 9 ½"
30 mm ø / 480 gms



Spare facings (Pair)



DMI-1981-422

Mallet 24 cm / 9 ½"
Disks and handle of Fiber 37 mm ø / 370 gms



DMI-1981-423

Mallet 22 cm / 8 ¾"
30 mm ø / 125 gms



DMI-1981-424

Mallet 26.5 cm / 10 ½" | 30 mm ø / 450 gms

- A: 20 .5cm / 8" | 25mm ø / 120 gms
- B: 21cm / 8 ¼" | 30mm ø / 180 gms
- C: 21.5cm / 8 ½" | 35mm ø / 260 gms

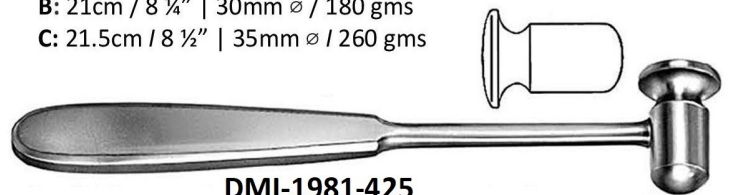

DMI-1981-425

Doyen Mallet

ELEVATORS SPINAL S/S & FIBER



DMI-1981-426
Herbert Mallet 19 cm / 7 ½"
For ulnar head prosthesis



DMI-1981-427
Collin Mallet 20 cm / 8"
23 mm ø / 220 gms



DMI-1981-428
Mallet 26.5 cm / 10 ½"
50 mm ø / 900 gms

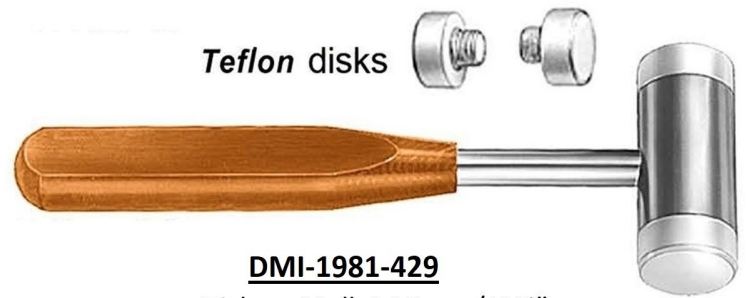

DMI-1981-429
Vickers Mallet 19 cm / 7 ½"
25 mm ø / 300 gms

Teflon disks



DMI-1981-430
Kirk Mallet 20cm / 8"
Head Dia 38mm / Weight: 1 lb. 4 oz. (570 grams)



Head Weight: 7 oz (200 grams)

DMI-1981-431
Gerzog Mallet 19 cm / 7 ½"
Head Dia 25mm / Weight 10 oz (285 grams)



Head Weight: 20 oz (567 grams)

DMI-1981-432
Heath Mallet 19 cm / 7 ½"
Head Dia 40mm / Weight 2 lbs. (907gm)



Head Weight: 20 oz (567 grams)

DMI-1981-433
Heath Mallet, SS 18 cm / 7" Solid Frame Handle
Head Dia 40mm / Weight 36 oz. (1020gm)

ELEVATORS SPINAL S/S & FIBER



DMI-1981-434

All Fibre Mallet 24 cm / 9 1/2"
Head Dia 80X60mm Weight 14oz. (397gm)



Fibre Handle

DMI-1981-435

Cloward Mallet 19cm / 7 1/2"
Head Dia 20mm / Weight 8oz. (227gm)



DMI-1981-436

Hajek Mallet 20 cm / 8"
Head Dia 27mm / Weight: 7 oz. (198gm)



Fibre Handle

DMI-1981-437

Narrow Tip Mallet 20cm / 8"
Head Dia 7mm Weight 6oz. (170gm)



B: Head Dia 35mm Weight 11b 40 oz. (570gm)
C: Head Dia 40mm Weight 11b 90 oz. (708gm)

DMI-1981-438

Fibre Handle Mallet 23cm / 9"
A: Head Dia 30mm / Weight 12 oz. (340gm)



DMI-1981-439

He-Man Mallet 28cm / 11"
Head Dia 38mm / 24mm / Weight 21b (906gm)

MENISCUS TENDON - CARTILAGE INSTRUMENTS

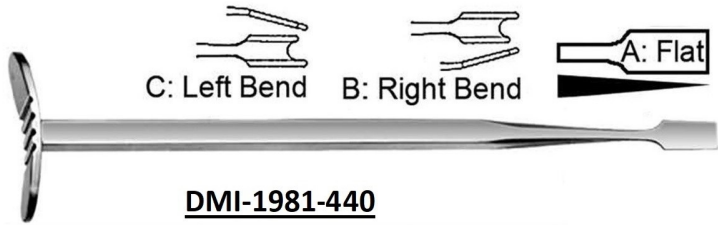

DMI-1981-440
Smillie Meniscus Knife 18 cm / 7"

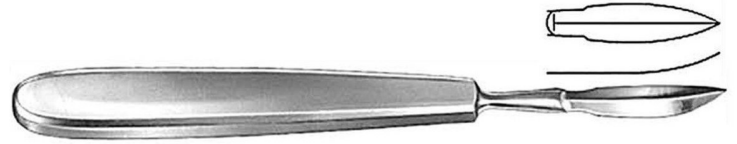

DMI-1981-441
Meniscus Knife 18 cm / 7"



DMI-1981-442
Neff Meniscus Knife 22 cm / 8 3/4"



DMI-1981-443
Salenius Meniscus Knife 21 cm / 8 1/4" A: Right / B: Left

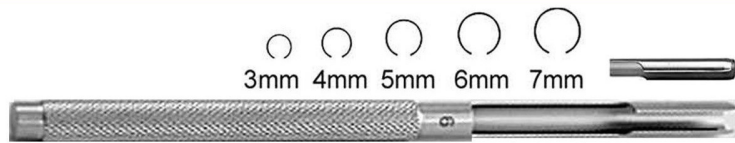

DMI-1981-444
Bunnell Tendon Stripper 15 cm / 6"



DMI-1981-445
Fischer Tendon Stripper 31 cm / 12 1/4" Blunt



DMI-1981-446
Tendon Passing Instrument 33.5 cm / 13 1/4"



DMI-1981-447
Fischer Tendon Stripper 31 cm / 12 1/4" Blunt



DMI-1981-448
Tendon Stripper 3 / 4 / 5 / 6mm
A: 28.5 cm / 11 1/4" B: 60 cm / 24"



DMI-1981-450
Bunnell Tendon Passer 23 cm / 9" Malleable



DMI-1981-451
Downing Cartilage Knife 25 cm / 10"
Concave Edge Cvd Blade w/ Guards



DMI-1981-452
Lowe Breck Cartilage Knife 25cm/10" STR Edge-Cvd Blade w / Guards

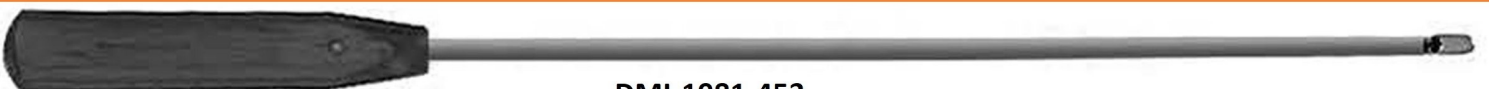

DMI-1981-453
Tendon Stripper 40 cm / 16" Fibre Handle

TENDON INSTRUMENTS



DMI-1981-354
Martin Cartilage Scissors 20cm / 8"

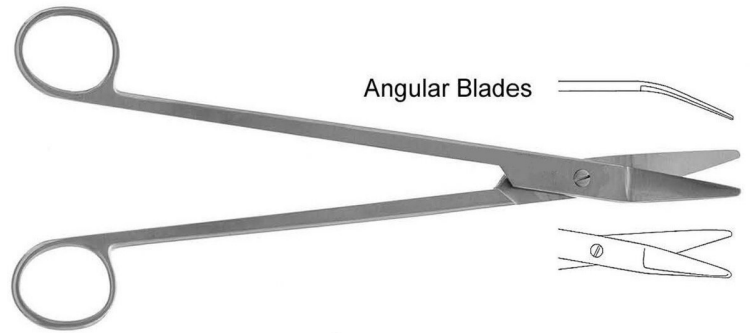

DMI-1981-355
Mueller Capsule Scissors 24 cm / 9 1/2"

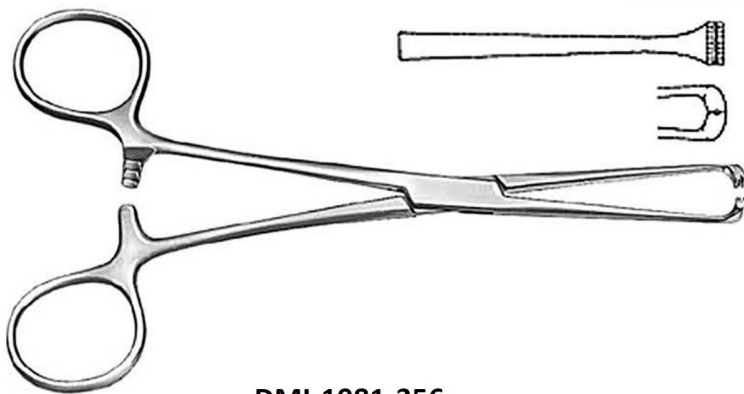

DMI-1981-356
Steinmann Tendon Holding Forceps 16 cm / 6 1/4"

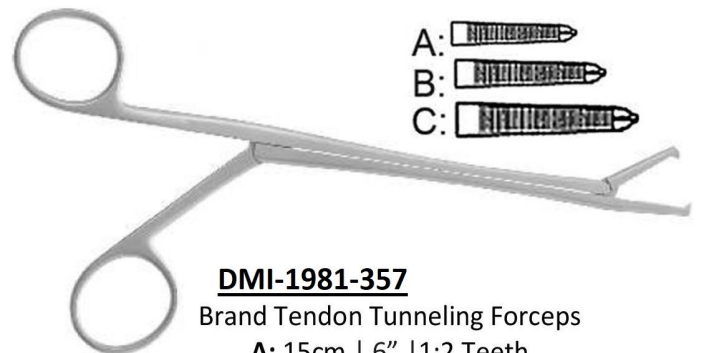

DMI-1981-357
Brand Tendon Tunneling Forceps
A: 15cm | 6" | 1:2 Teeth
B: 19cm | 7 1/2" | 1:2 Teeth
C: 24.5cm | 9 3/4" | 1:2 Teeth

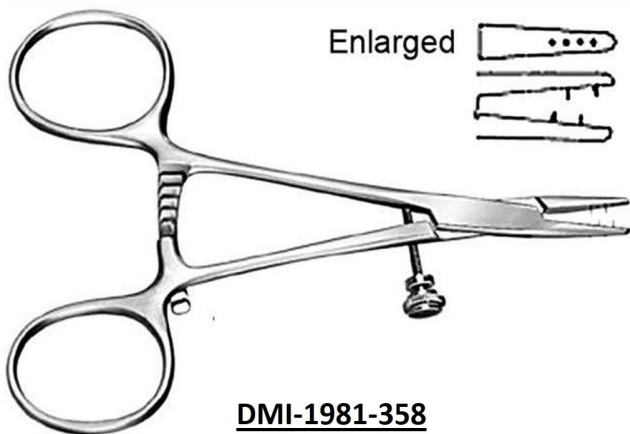

DMI-1981-358
Tendon Holding Forceps
11.5cm / 4 1/2"

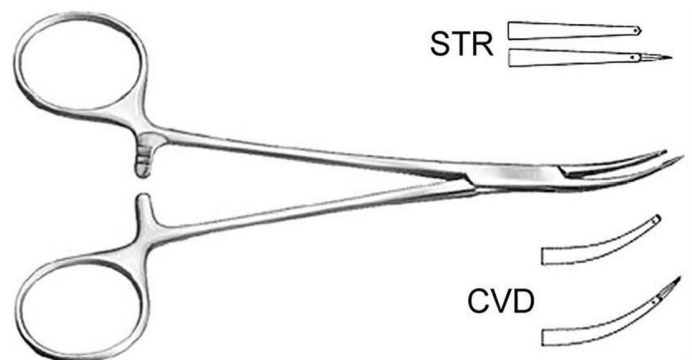

DMI-1981-359
Tendon Interlacing Forceps
15.5 cm / 6" Pointed



TENDON INSTRUMENTS

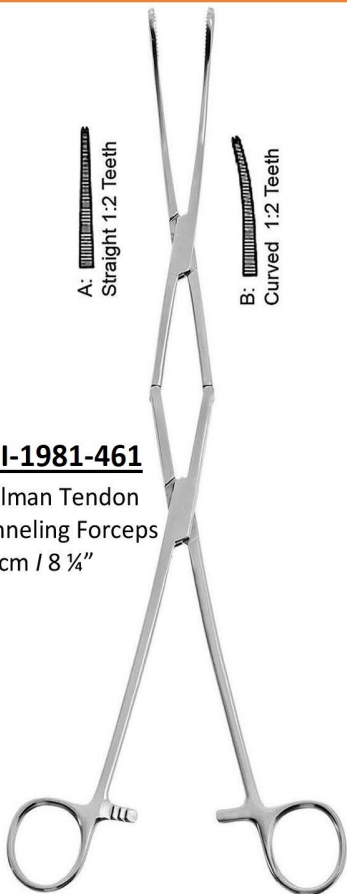

DMI-1981-460
Carroll Tendon Holding Forceps
11.5 cm / 4 1/2"



DMI-1981-461
Hallman Tendon Tunneling Forceps
21 cm / 8 1/4"

A:  Straight 1:2 Teeth
B:  Curved 1:2 Teeth

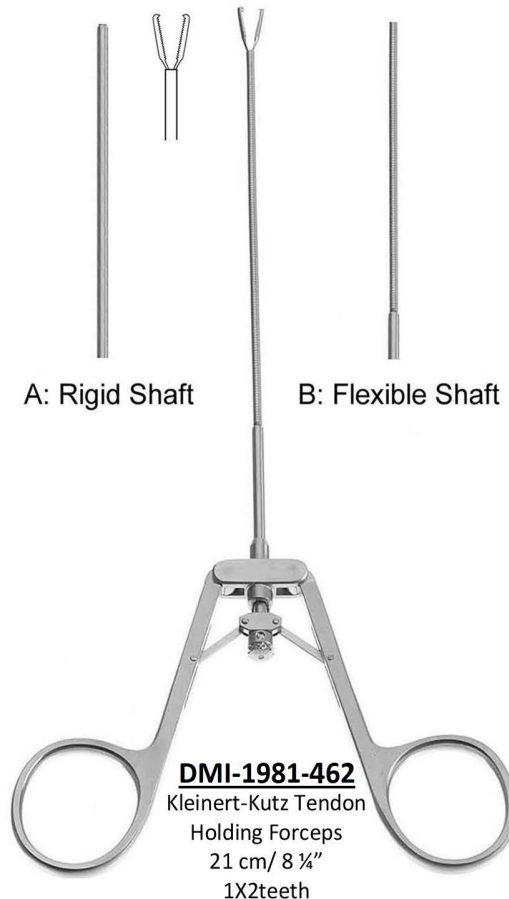

DMI-1981-462
Kleinert-Kutz Tendon Holding Forceps
21 cm / 8 1/4"
1X2teeth

A: Rigid Shaft B: Flexible Shaft



DMI-1981-463
Hoen Grasping Forceps
14 cm / 5 1/2" (Shaft)
1X2 teeth

TENDON INSTRUMENTS

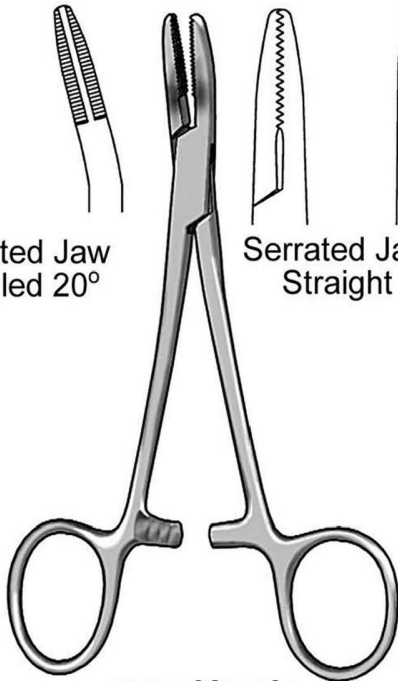
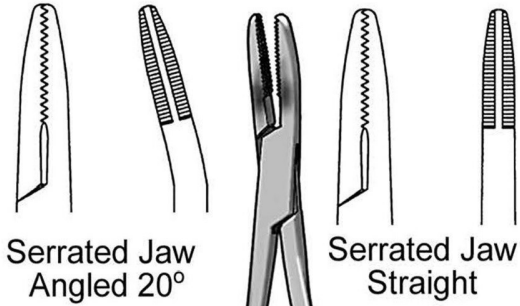

DMI-1981-464
Meniscus Clamp
13.5 cm / 5 3/8" 1X2 teeth

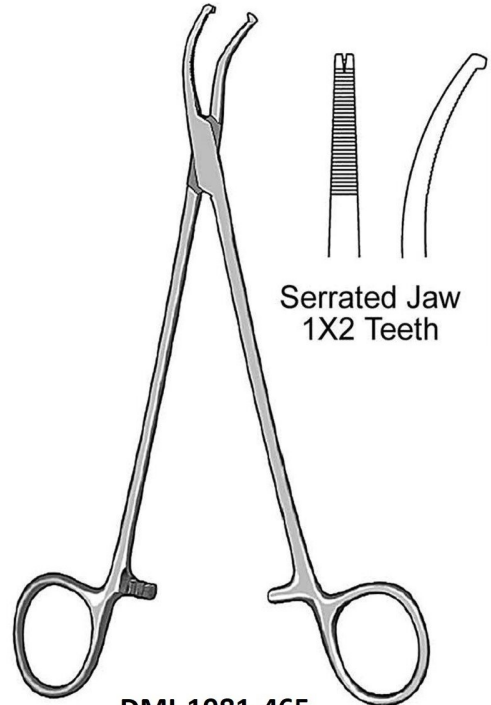

DMI-1981-465
Preston Ligamentum Flavum Forceps
(Meniscus) 18.5 cm / 7 1/4"



Straight

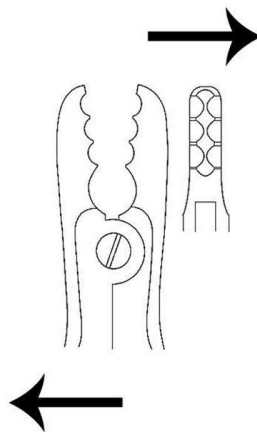

DMI-1981-466
Ortho Grasper 21 cm / 8 1/2"
7 X 20 MM Bite

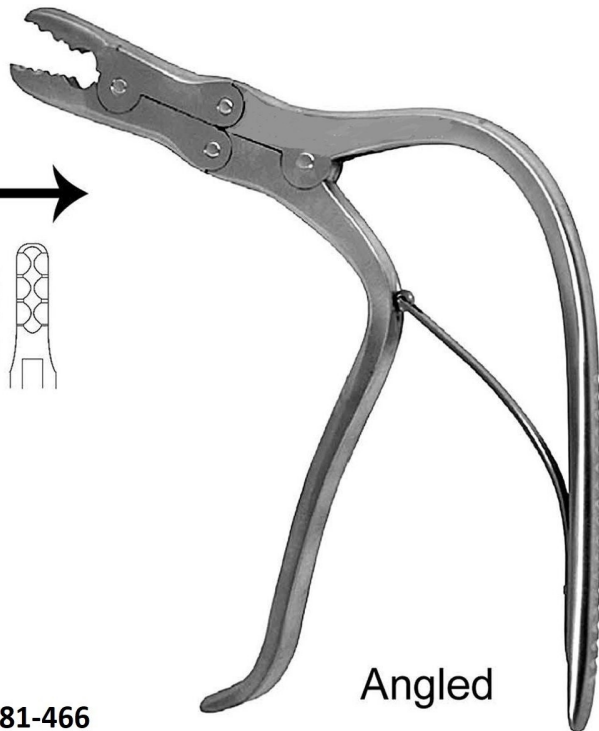

Angled

PELVIC REDUCTION FORCEPS

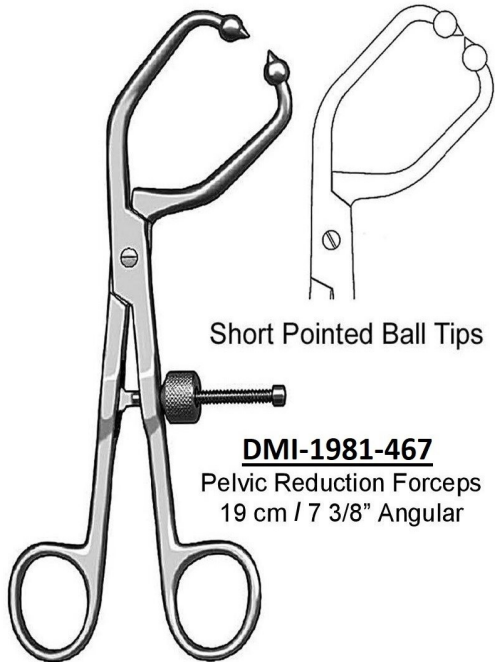

Short Pointed Ball Tips

DMI-1981-467
Pelvic Reduction Forceps
19 cm / 7 3/8" Angular

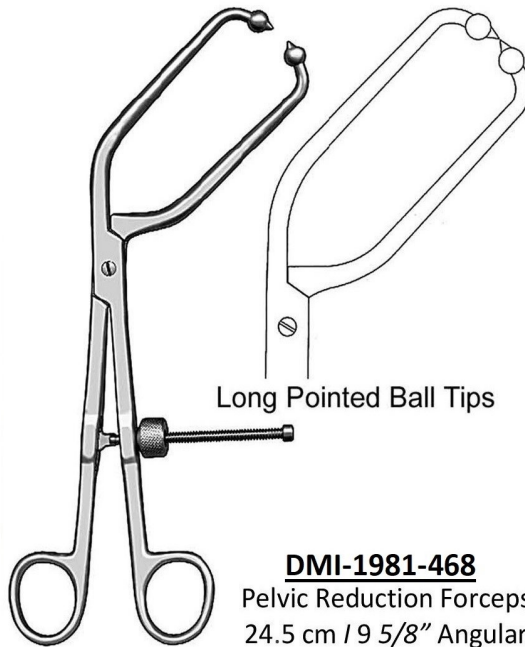

Long Pointed Ball Tips

DMI-1981-468
Pelvic Reduction Forceps
24.5 cm / 9 5/8" Angular

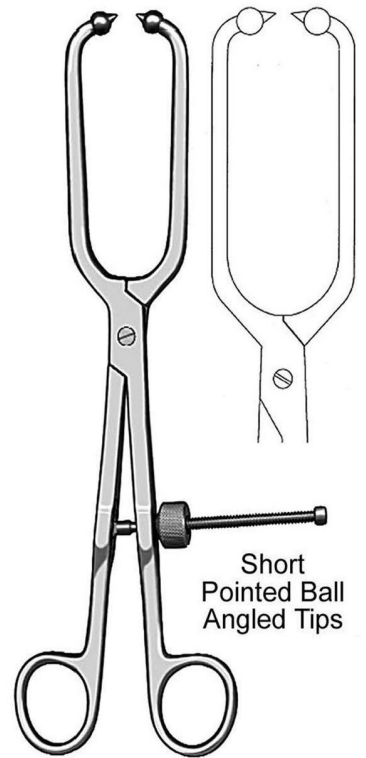

Short Pointed Ball Angled Tips

DMI-1981-469
Pelvic Reduction Forceps
25 cm / 10"



Long Pointed Ball Tips

DMI-1981-471
Pelvic Reduction Forceps
Available in 2 Sizes
A: 24 cm / 9 1/2"
B: 41cm / 16"

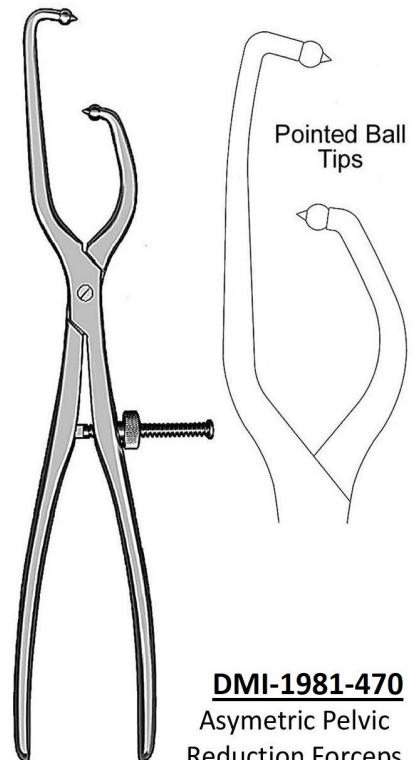

Pointed Ball Tips

DMI-1981-470
Asymmetric Pelvic Reduction Forceps
41 cm / 16"

PELVIC REDUCTION FORCEPS

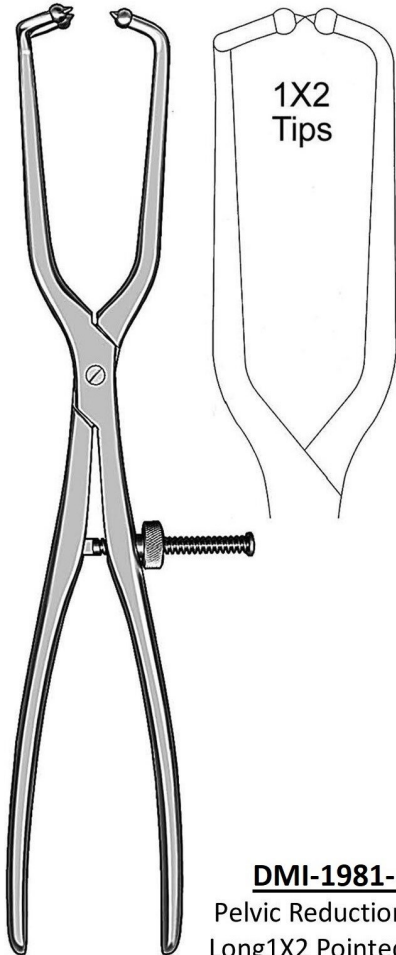

DMI-1981-472
Pelvic Reduction Forceps
Long 1X2 Pointed Ball Tips
41 cm / 16"

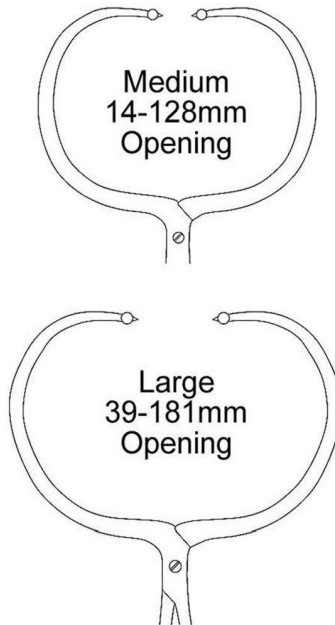

DMI-1981-473
Periarticular Reduction Forceps
Straight / Pointed Ball Tips
38 cm / 15"



DMI-1981-474
Pelvic Reduction Forceps
Adjustable Jaws for Screws
A: 25 cm / 10" B: 33 cm / 13"

BONE HOLDING FORCEPS

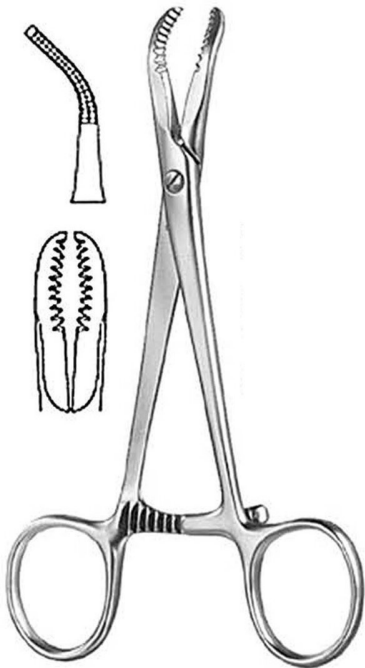

DMI-1981-475
Bone Holding Forceps
14 cm / 5 1/2"

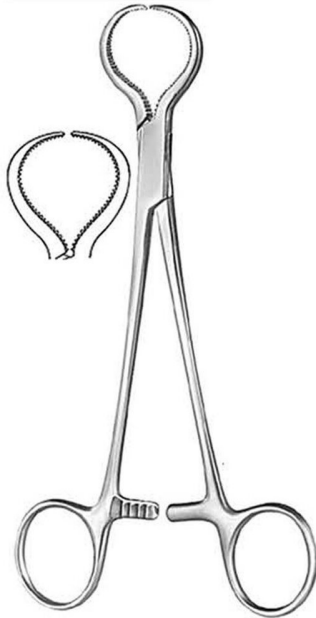

DMI-1981-476
Lewin Bone Holding Forceps
18.5 cm / 7 1/4"



DMI-1981-477
Bone Holding Forceps
14 cm / 5 1/2" Delicate



DMI-1981-478
Frosch Bone Holding Forceps 18 cm / 7"



DMI-1981-479
Bone Holding Forceps 20 cm / 8"



DMI-1981-480
Semb Bone Holding Forceps 19 cm / 7 1/2"



21 cm / 8 1/4"
DMI-1981-481
Lengenbeck Bone Holding Forceps 21 cm / 8 1/4"

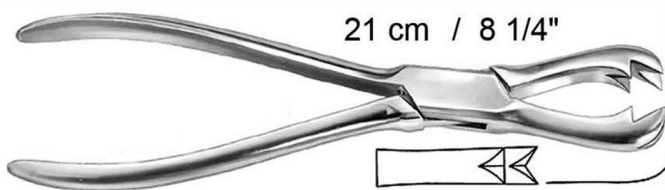

21 cm / 8 1/4"
DMI-1981-482
Fergusson Bone Holding Forceps Heavy pattern



A: 23 cm / 9" B: 26 cm / 10 1/4"
Farabeuf Bone Holding Forceps **DMI-1981-483**

BONE HOLDING FORCEPS



DMI-1981-484
Kern Bone Holding Forceps
A: 17 cm / 6 ¾"
B: 21 cm / 8 ¼"

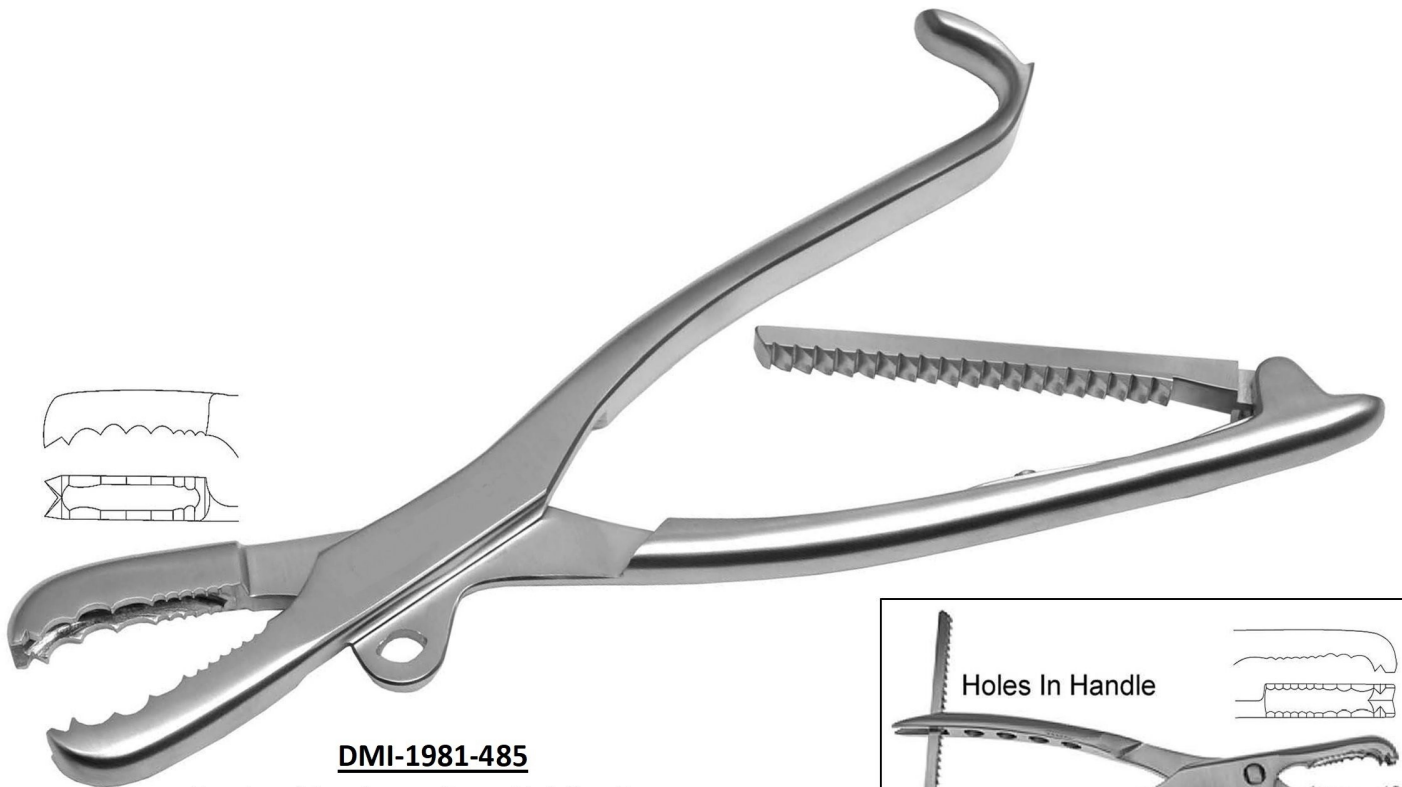

DMI-1981-485
Farabeuf Lambotte Bone Holding Forceps
A: 23 cm / 9" | B: 26 cm / 10"
Adjustable / with Ratchet

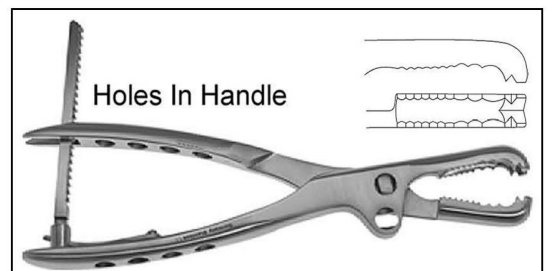

BONE HOLDING FORCEPS



DMI-1981-486

Lambotte Bone Holding Forceps
w / Swivel Head, Adjustable Jaw

A: 22 cm | 8 ¾" | **B:** 27 cm | 10 ¾" | **C:** 30 cm | 11 ¾"



DMI-1981-487

Ulrich Bone Holding Forceps
w / Thread Fixation 19 cm / 7 ¼"

DMI-1981-488
Ulrich Bone Holding Forceps
w / Thread Fixation
A: 23 cm | 9" | **B:** 25 cm | 9 ¾" | **C:** 28 cm | 11"

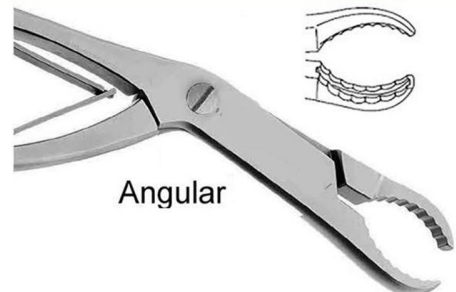

Angular

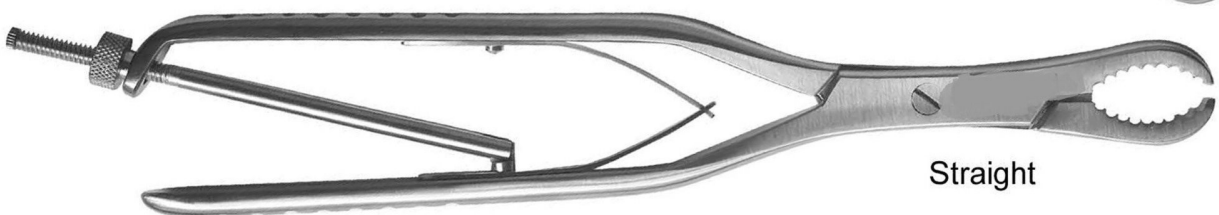

Straight

BONE HOLDING FORCEPS

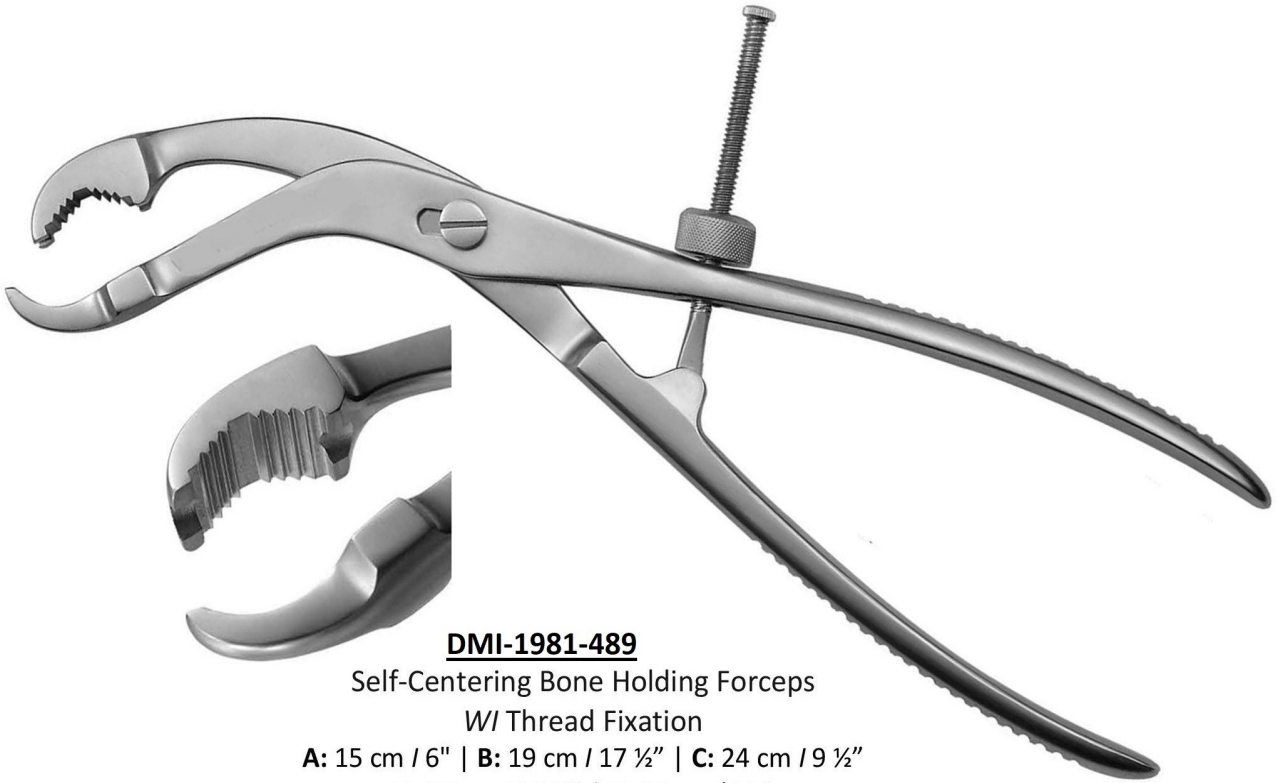

DMI-1981-489

Self-Centering Bone Holding Forceps
W/ Thread Fixation

A: 15 cm / 6" | **B:** 19 cm / 17 1/2" | **C:** 24 cm / 9 1/2"
D: 26 cm / 10 1/4" | **E:** 28 cm / 11"



DMI-1981-490

Lane Bone Holding Forceps w / Ratchet

A: 33 cm / 13"
B: 45 cm / 17 3/4"

Without Ratchet

BONE HOLDING FORCEPS



DMI-1981-491

Hey Groves Bone Holding Forceps

A: 20 cm / 8" | B: 25 cm / 10" | C: 30 cm / 12"



DMI-1981-492

Verbrugge Bone Holding Forceps

A: 17.5 cm / 7" | B: 25 cm / 9 3/4"
C: 26 cm / 10 1/4" | D: 27 cm / 10 3/4"



DMI-1981-493

Smooth Jaws Bone Holding Forceps

23 cm / 9"

BONE HOLDING FORCEPS

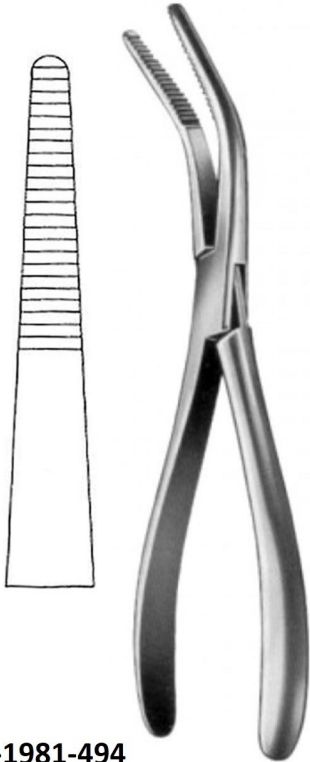

DMI-1981-494
Van Buren Bone Holding Forceps
21.5 cm / 8 1/2"

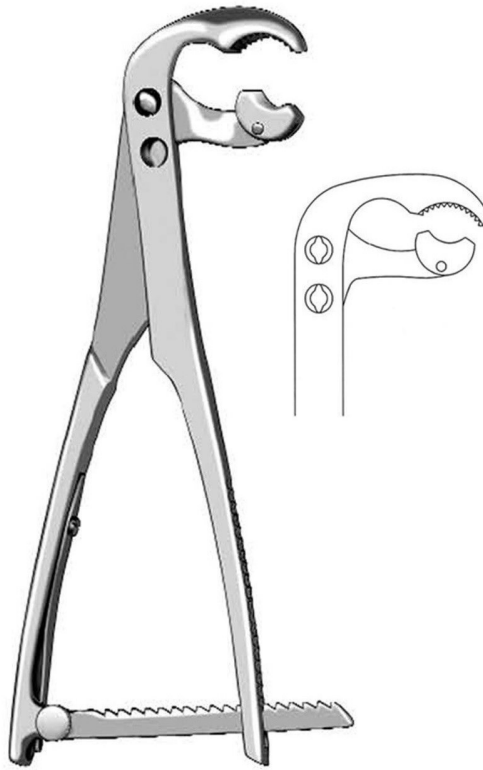

DMI-1981-495
Angled Bone Holding Forceps 23 cm / 9"

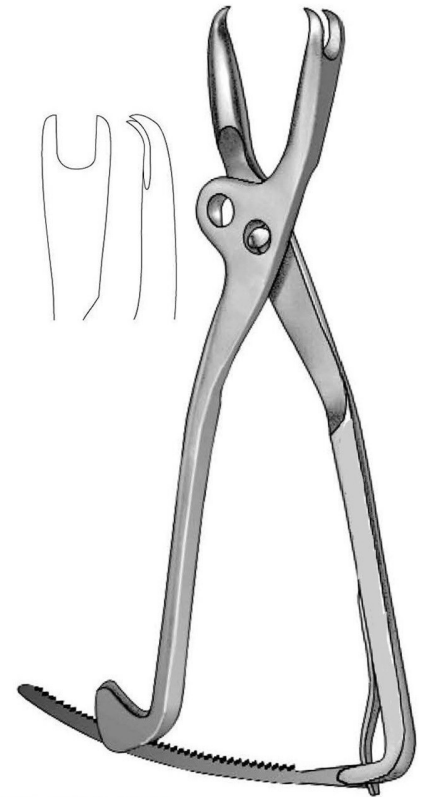

DMI-1981-496
Bishop Bone Holding Forceps 23 cm / 9"



DMI-1981-497
Bone Holding Forceps
A: 17cm 6 3/4" 0.9mm
B: 13cm 5 1/4" 1.6mm

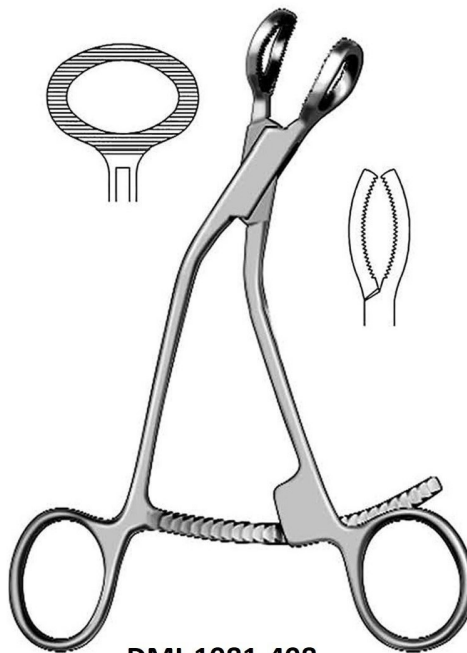

DMI-1981-498
Bishop Bone Holding Forceps
23 cm / 9"

1X2 Prong



2X2 Prong

DMI-1981-499
Patella Forceps 18 cm / 7"

BONE HOLDING FORCEPS



DMI-1981-500
Hayton Williams Forward Traction Forceps
Broad Tips 23 cm / 9"



DMI-1981-501
Fibula Bone Holding Forceps
21 cm / 8 ½"



DMI-1981-503
Semb Bone Holding Forceps
Curved Sideward
21 cm / 8 ½"

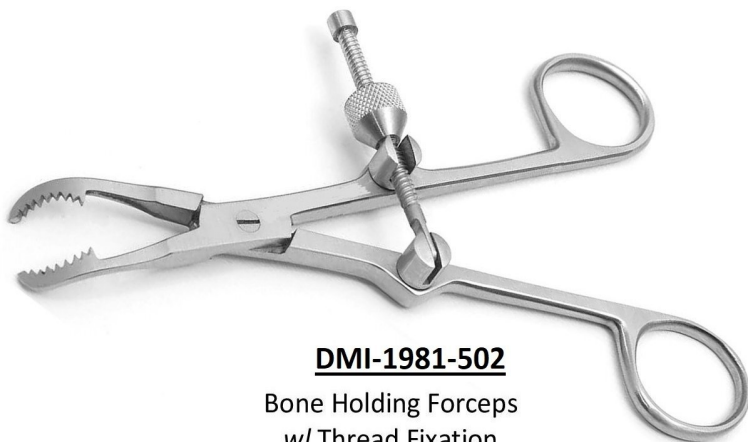

DMI-1981-502
Bone Holding Forceps
w/ Thread Fixation
15 cm / 6"

BONE HOLDING FORCEPS



Small

Large

DMI-1981-504

Bargo Bone Holding Forceps 15 cm / 6"



DMI-1981-505

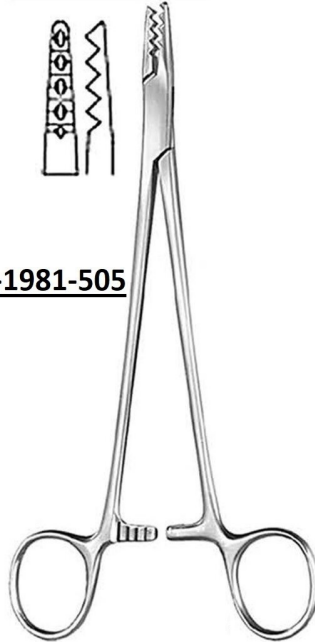

Martin Cartilage Seizing Forceps
18.5 cm / 7 1/4"

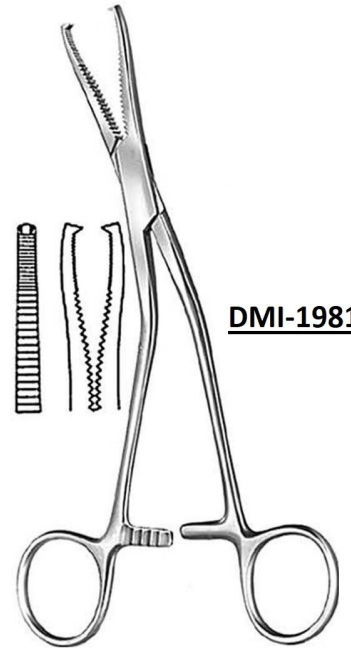

DMI-1981-506

Dingmann Cartilage Seizing Forceps
18.5 cm / 7 1/4"



DMI-1981-507



Reposition Forceps
13.5 cm / 5 1/4" Long ratchet pointed

DMI-1981-508



Reposition Forceps
15 cm / 6" Long Ratchet Pointed

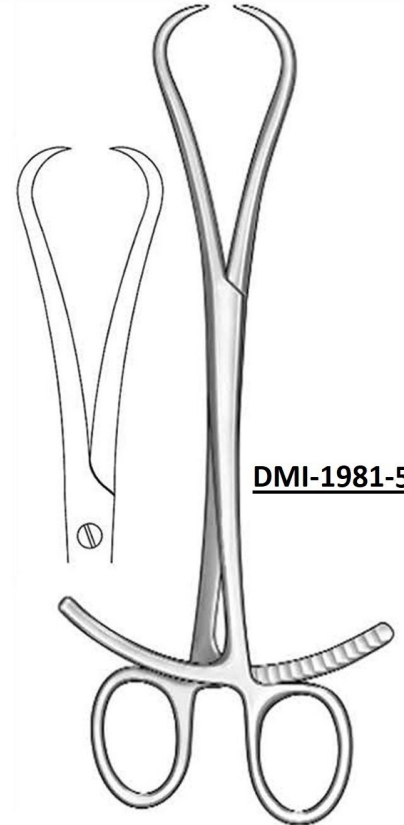

DMI-1981-509

Walton Bone Reduction Forceps
20.5 cm / 8" | 2" Double Ratchet
Opening 9-100mm

REPOSITION- CRATILAGE FORCEPS

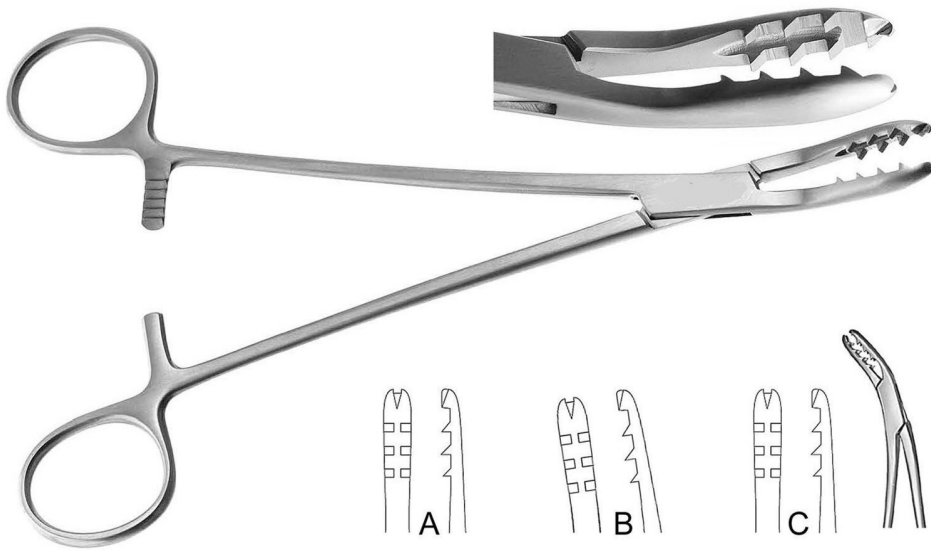

DMI-1981-510

Cartilage Seizing Forceps

A: Straight | B: Upward Cvd | C: Sideward Cvd

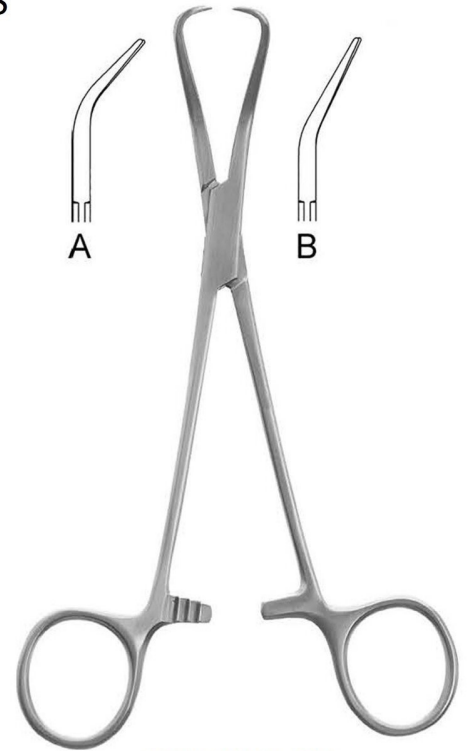

DMI-1981-511

Glenoid Perforating Forceps 17cm / 6 1/2"

A: Strong Cvd | B: Slight Cvd



DMI-1981-512

Bone Reposition Forceps
w / Thread Fixations Screw

A: 17 cm / 6 3/4"
B: 24 cm / 9 1/2"



DMI-1981-513

Reill Bone Reduction Forcep
17.5 cm / 7"

BONE CUTTING FORCEPS

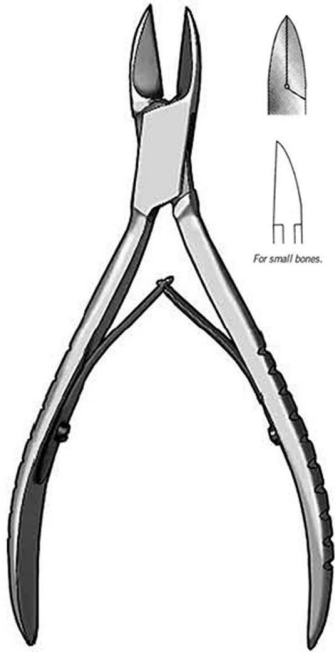

DMI-1981-514

Littauer Bone Cutting Forceps
15 cm / 6"



DMI-1981-515

Marwalder Bone Nipper
18.5 cm / 7 1/4"



DMI-1981-516

Cottle Kazanjian Bone Cutting
Forceps 18.5 cm / 7 1/4"

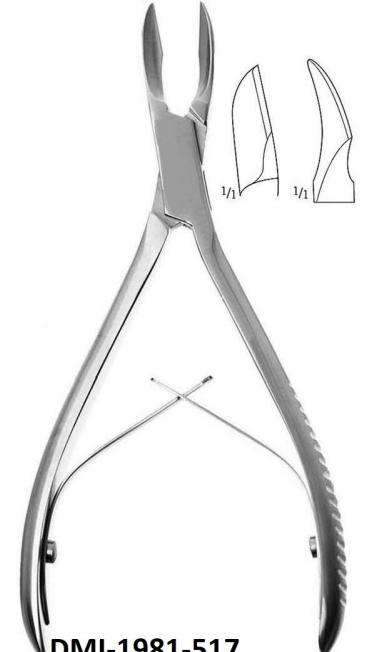

DMI-1981-517

Cleveland Bone Cutting Forceps
A: 14.5 cm / 5 3/4"
B: 17 cm / 6 3/4"



DMI-1981-518

Liston Bone Cutting Forceps

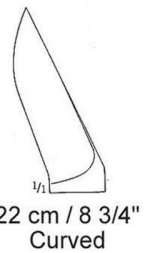
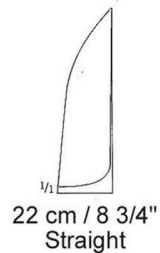
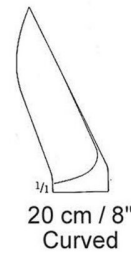
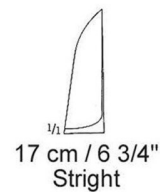
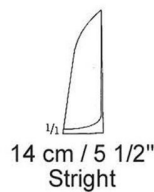

BONE CUTTING FORCEPS

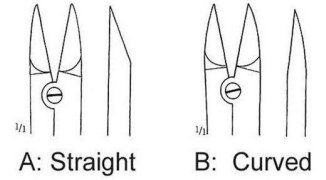

DMI-1981-519
Kleinert-Kutz / Bohler Bone Cutting
Forceps 14.5 cm / 5 ¾"

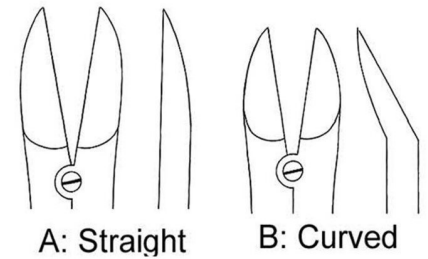

DMI-1981-520
Ruskin Liston Bone Cutting Forceps
18 cm / 7"

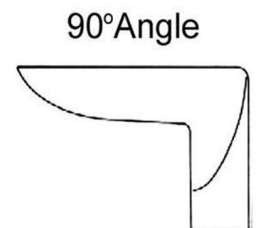

DMI-1981-521
Stille-Liston Bone Cutting Forceps
26 cm / 10 ¼"

BONE CUTTING FORCEPS

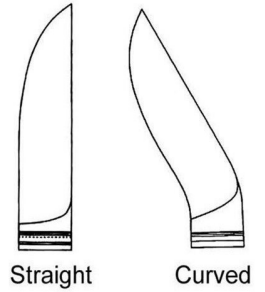

DMI-1981-522
Stille-Liston Bone Cutting Forceps
A: 23 cm / 9" | B: 27.5 cm / 10 ¾"



DMI-1981-523
Cleveland Bone Cutting Forceps
16 cm / 6 ¼"

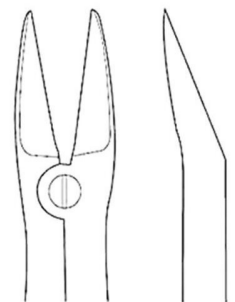

DMI-1981-524
Me Indoe Bone Cutting Forceps
18 cm / 7" Delicate Blades

BONE CUTTING FORCEPS

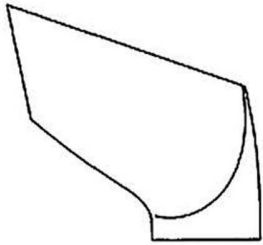

45° Angled

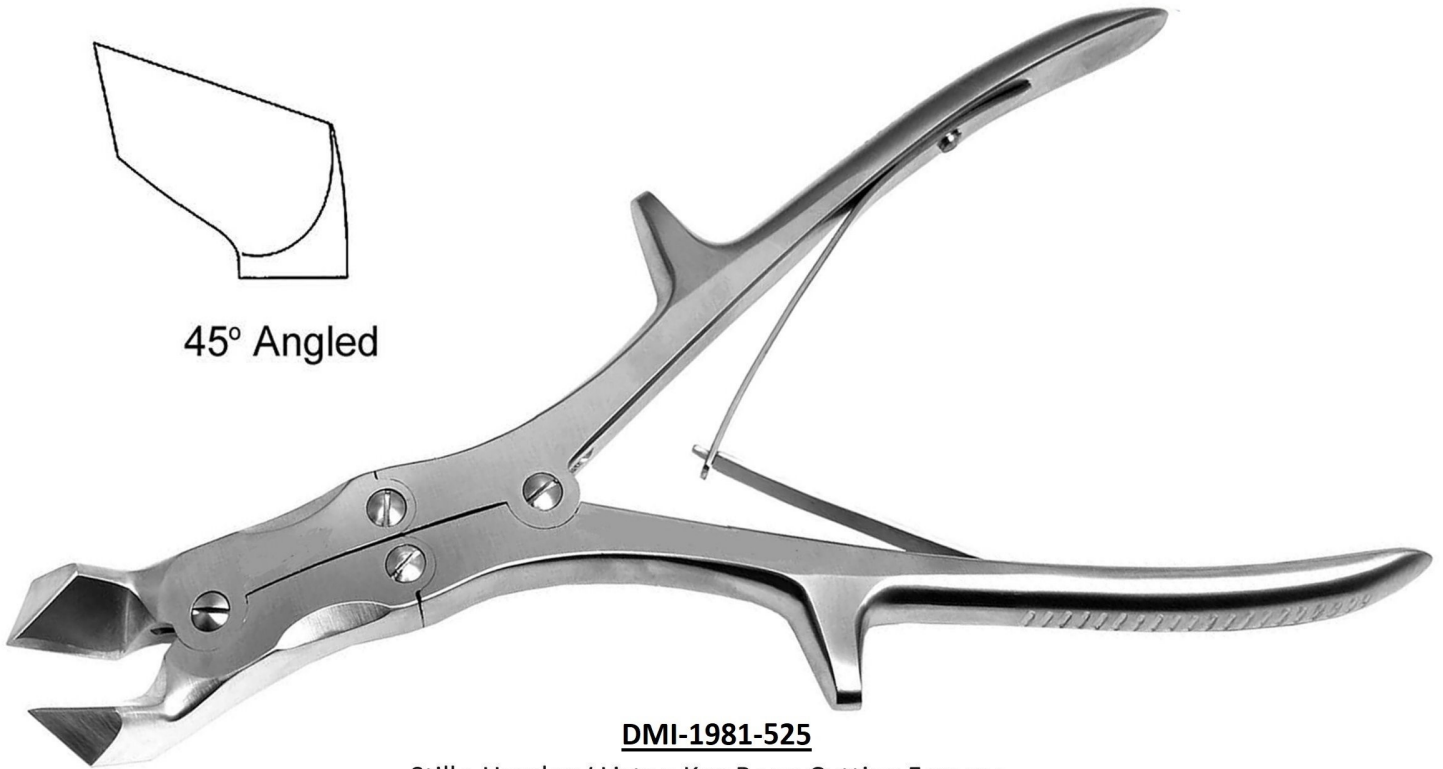

DMI-1981-525

Stille-Horsley / Liston Key Bone Cutting Forceps
25.5 cm / 10"

90° Angled

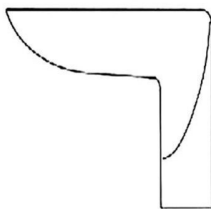

Angled On Side



DMI-1981-526

Semb Bone Cutting Forceps
24.5 cm / 9 3/4"

BONE RONGEURS- NIBBLERS

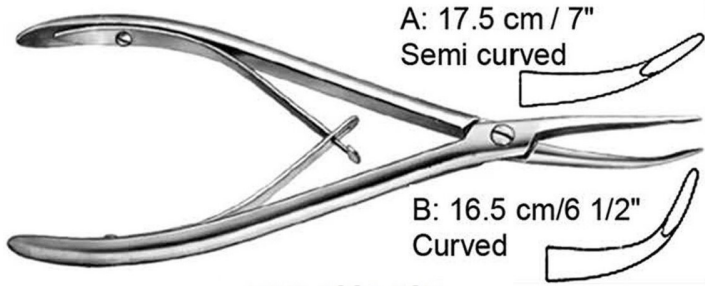

DMI-1981-527
Stellbrink Bone Rongeur



DMI-1981-528
Friedmann Bone Rongeur
A: 12.5 cm / 5" | B: 13.5 cm / 5 1/4"



DMI-1981-529
Friedmann Bone Rongeur
13.5 cm / 5 1/4"



DMI-1981-530
Cleveland Bone Rongeur
A: 13.5 cm / 5 1/4" | B: 16.5 cm / 6 1/2"



DMI-1981-531
Mead Bone Rongeur 16.5 cm / 6 1/2"

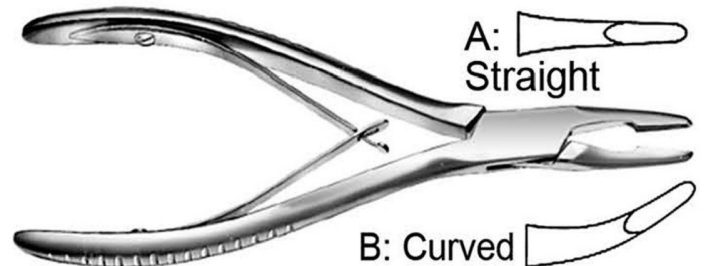

DMI-1981-532
Jansen Bone Rongeur 18 cm / 7"

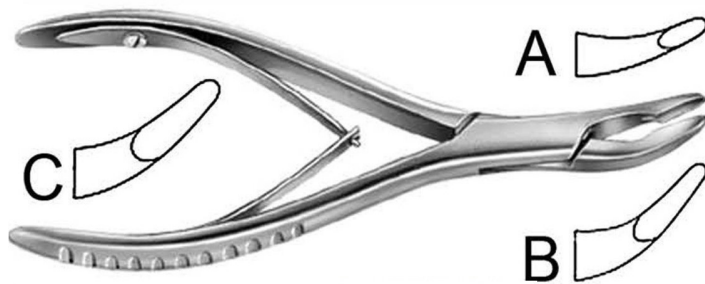

DMI-1981-533
Luer Bone Rongeur 14.5 cm / 5 3/4"

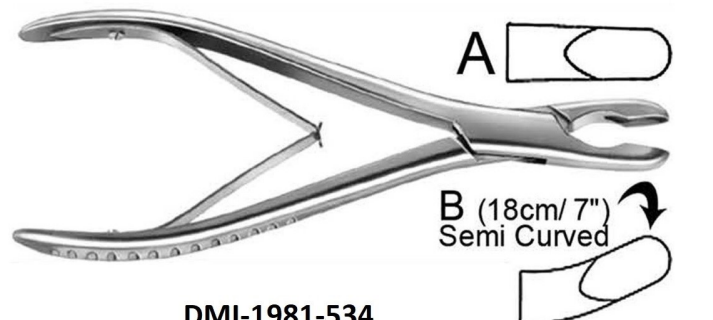

DMI-1981-534
Luer Bone Rongeur 18.5 cm / 7 1/4"

BONE RONGEURS- NIBBLERS

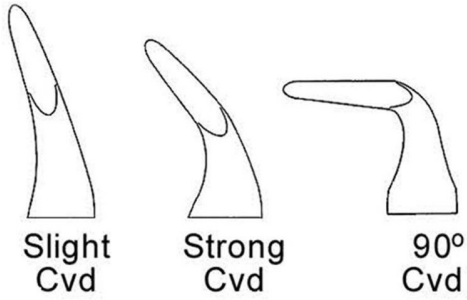

DMI-1981-535
Blumental Bone Rongeur 12.5 cm / 5"

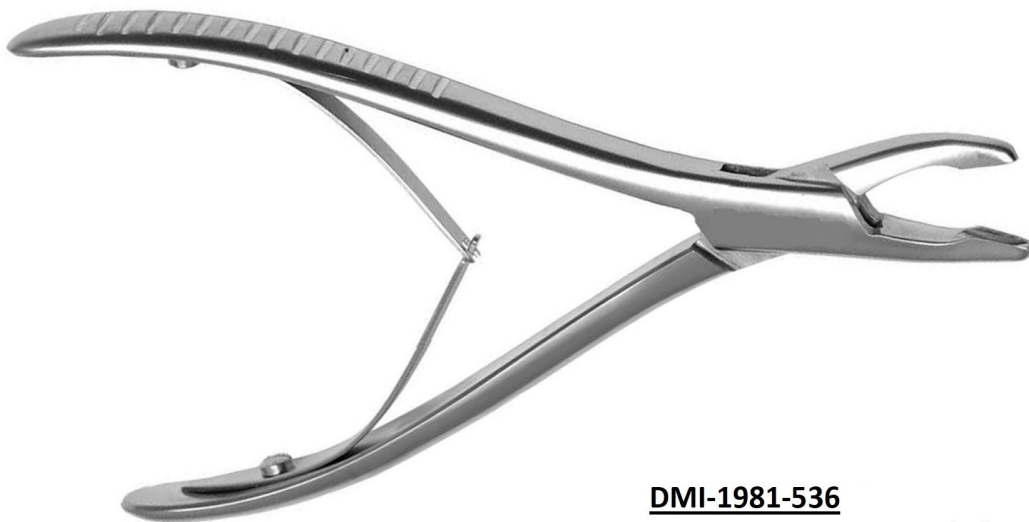

DMI-1981-536
Hartmann Bone Rongeur 17.5 cm / 7"

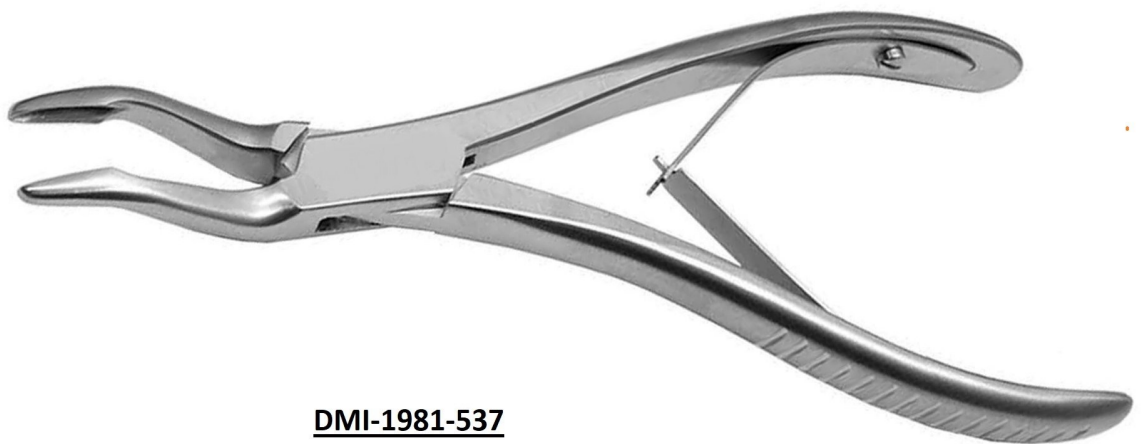

DMI-1981-537
Jansen Bone Rongeur 19 cm / 7 1/2" Bayonet

BONE RONGEURS- NIBBLERS



DMI-1981-538

Jansen Bone Rongeur Straight

A: 14 cm / 5 ½"

B: 17 cm / 6 ½"



DMI-1981-539

Jansen Bone Rongeur Delicate

14 cm / 5 ½"

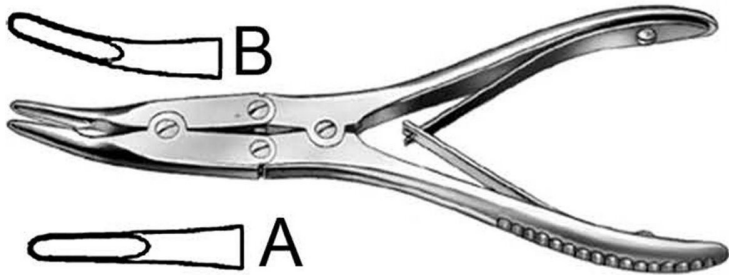

DMI-1981-540 Bohler Bone Rongeur 15.5 cm / 6"



Beyer Bone Rongeur 18 cm / 7" **DMI-1981-541**



DMI-1981-542

Zaufai-Jansen Bone Rongeur 18 cm / 7"



DMI-1981-543

Mayfield Bone Rongeur 18 cm / 7"



DMI-1981-544

Marquard Bone Rongeur 20.5 cm / 8"

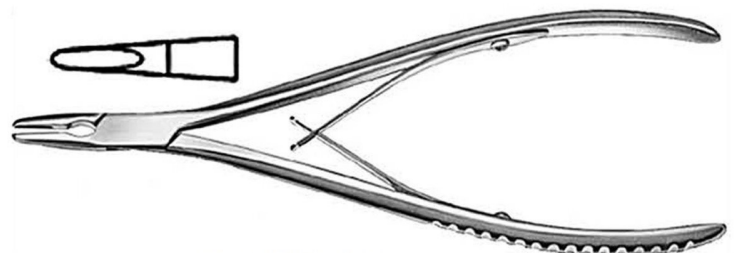

DMI-1981-545

Lempert Bone Rongeur 19 cm / 7 ½"

BONE RONGEURS- NIBBLERS



DMI-1981-546
Stille Bone Rongeur
22.5 cm / 8 ¾"

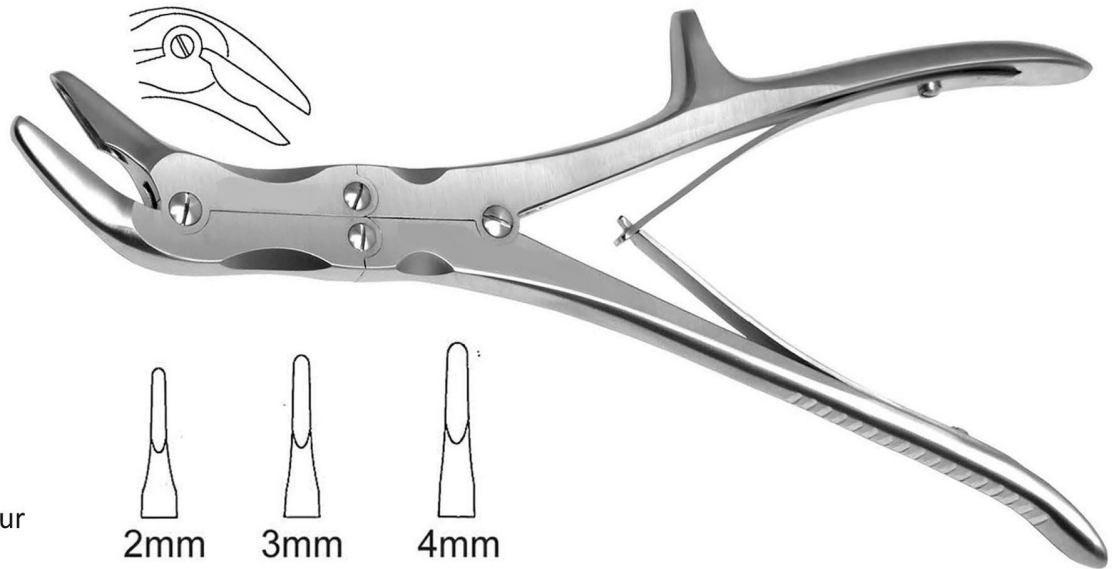

DMI-1981-547
Echlin Duckbill Bone Rongeur
22 cm / 8 ¾"

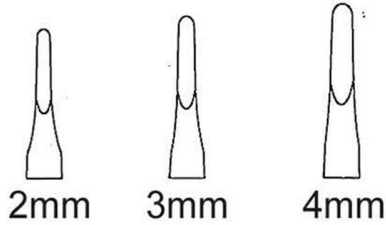

DMI-1981-548
Ruskin Bone Rongeur
18 cm / 7"

BONE RONGEURS- NIBBLERS



DMI-1981-549
Ruskin Bone Rongeur
24 cm / 9 ½"

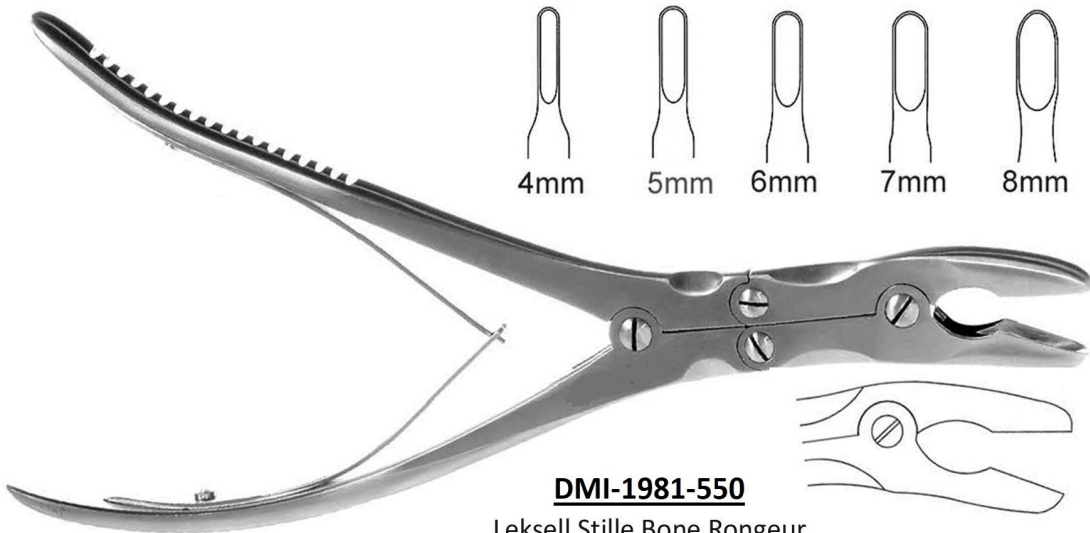

DMI-1981-550
Leksell Stille Bone Rongeur
24 cm / 9 ½"

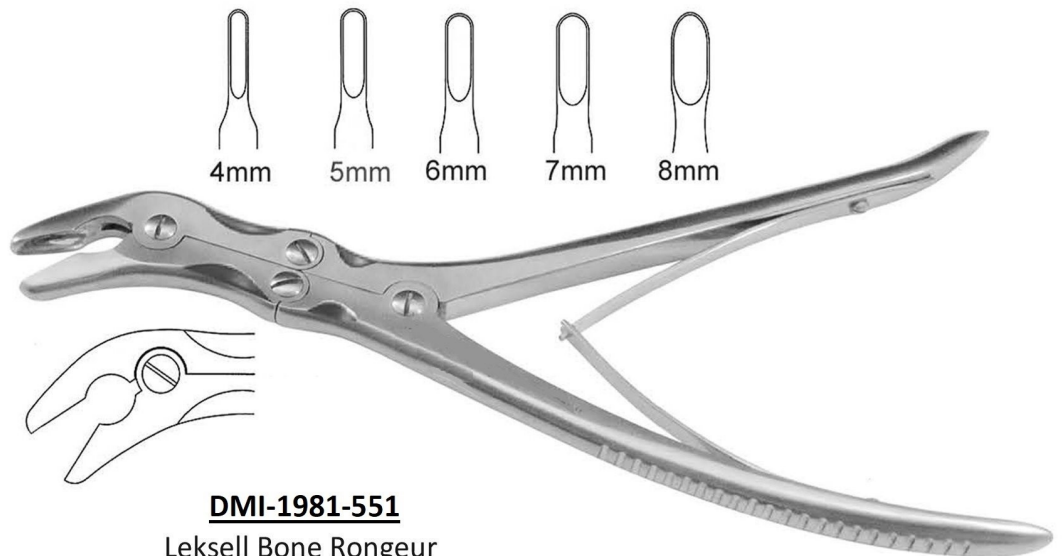

DMI-1981-551
Leksell Bone Rongeur
24 cm / 9 ½"

BONE RONGEURS- NIBBLERS



DMI-1981-552

Leksell Bone Rongeur
23 cm / 9"

- A: Straight
- B: Slight Curved
- C: Strong Curved
- D: Extra Strong Cvd

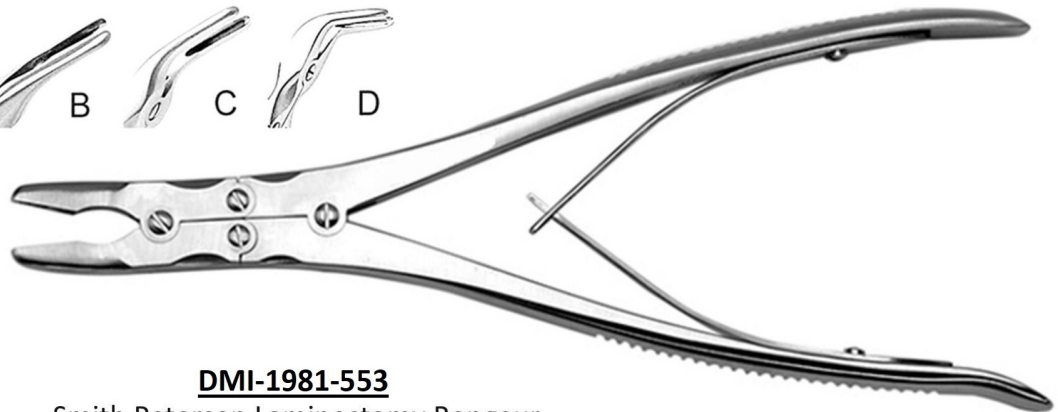

DMI-1981-553

Smith Peterson Laminectomy Rongeur
24 cm / 9 ½"

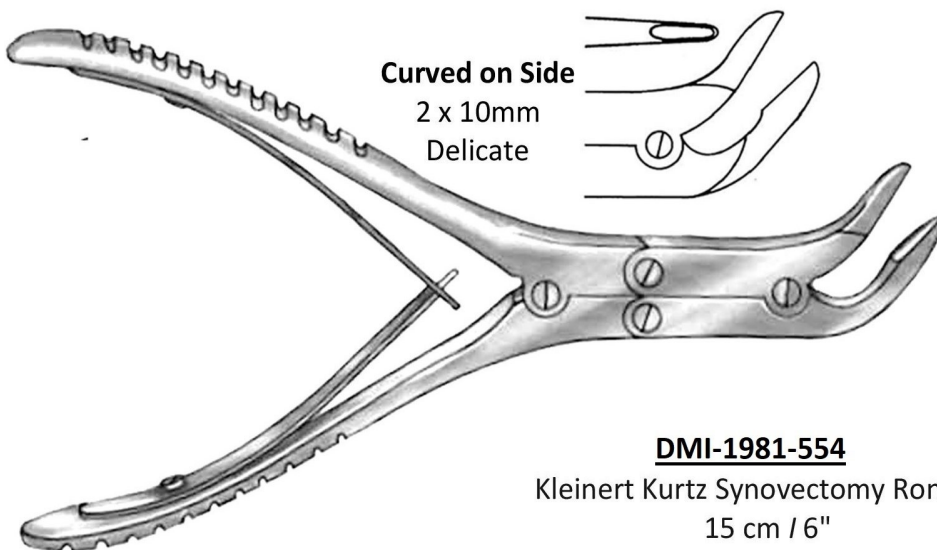

Curved on Side
2 x 10mm
Delicate

DMI-1981-554

Kleinert Kurtz Synovectomy Rongeur
15 cm / 6"

BONE RONGEURS- NIBBLERS

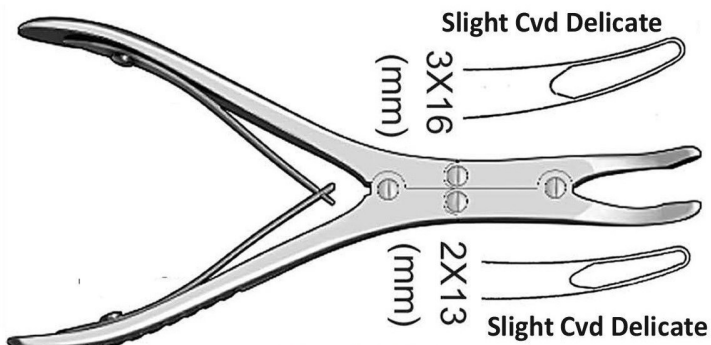

DMI-1981-555

Kleinert Kurtz Synovectomy Rongeur 15 cm / 6"

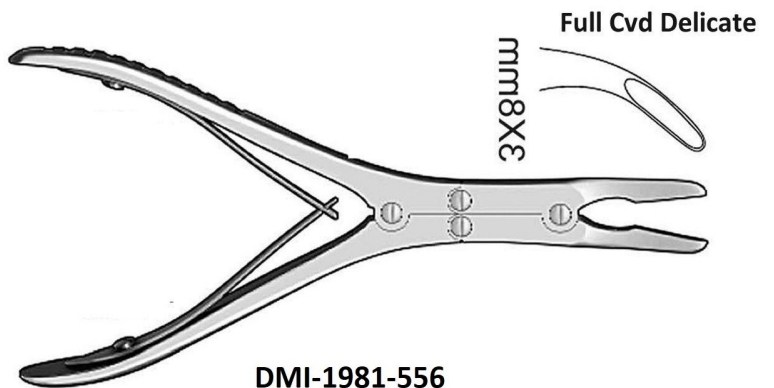

DMI-1981-556

Kleinert Kurtz Synovectomy Rongeur 15 cm / 6"



DMI-1981-557

Semb Bone Rongeur 23.5 cm / 9 1/4"

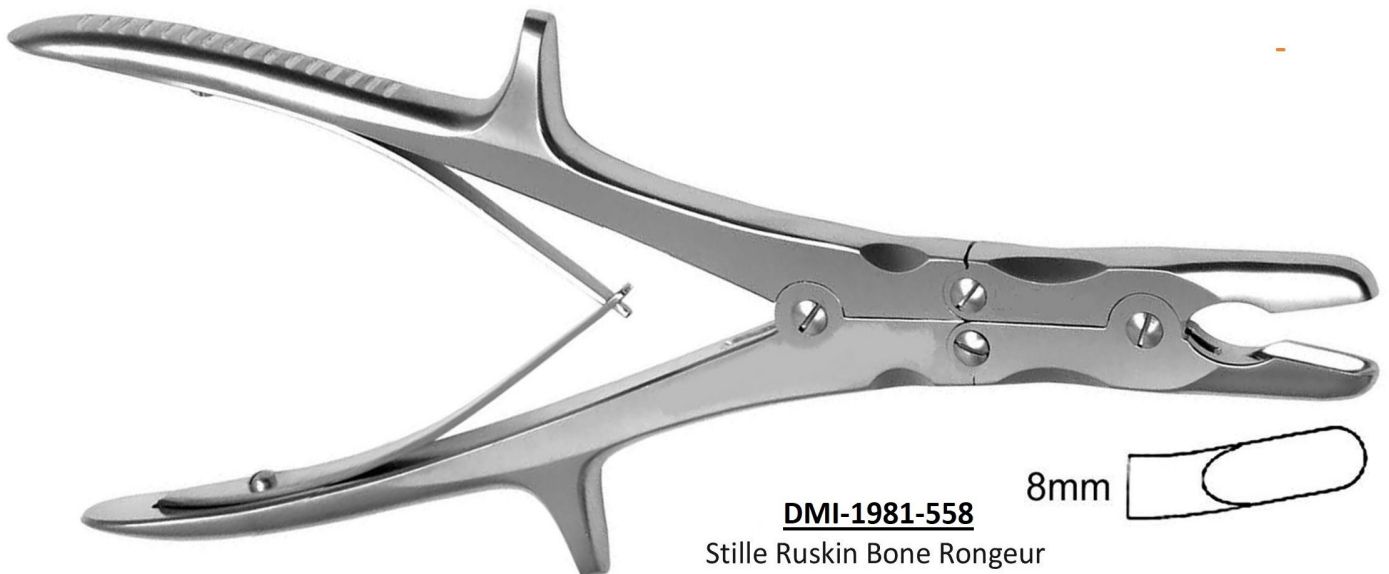

DMI-1981-558

Stille Ruskin Bone Rongeur
23.5 cm / 9 1/4"

BONE RONGEURS- NIBBLERS

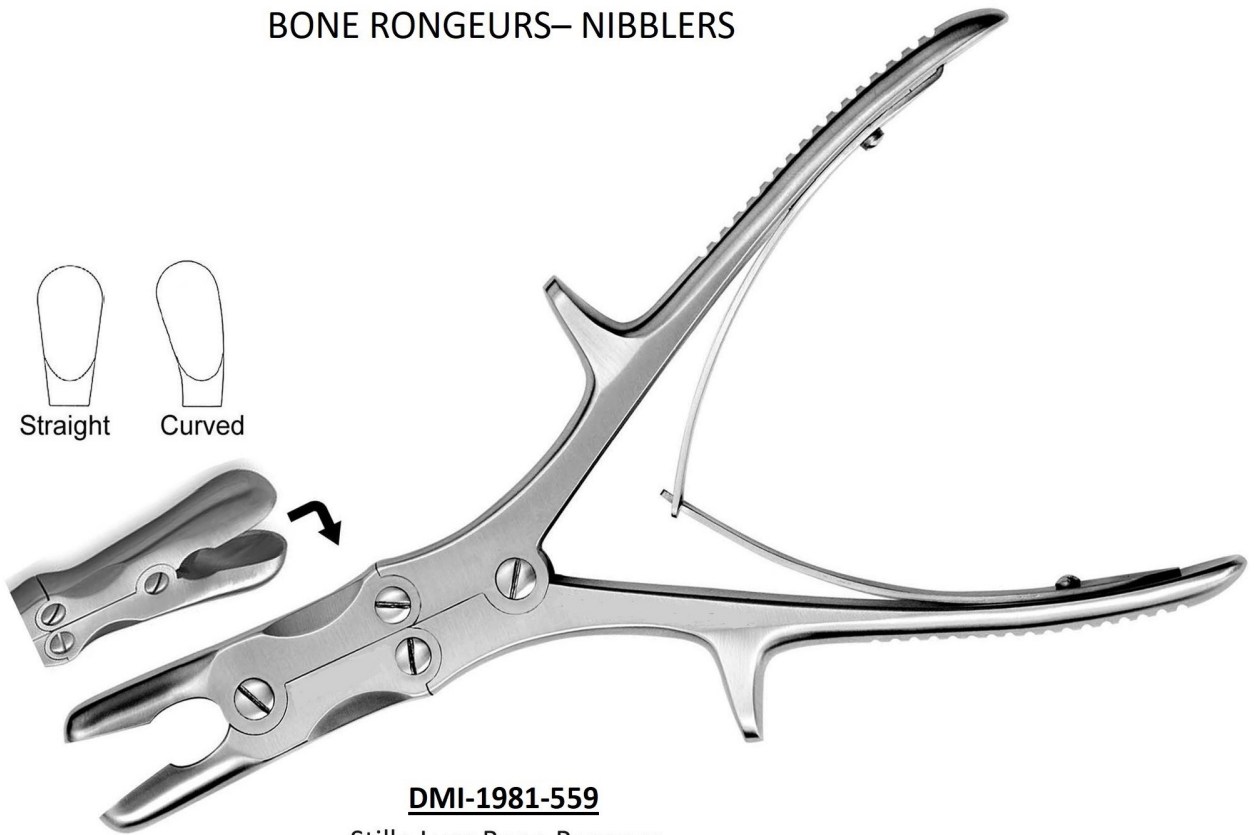

DMI-1981-559

Stille Luer Bone Rongeur
26.5 cm / 10 1/2"



DMI-1981-560

Stille Luer Bone Rongeur
22.5 cm / 8 3/4"

BONE RONGEURS- NIBBLERS



DMI-1981-561
Mainz Long Neck Bone Rongeur
18 cm / 7"



DMI-1981-562
Leksell Bayonet Rongeur
41 cm / 16"

A: 3mm
B: 5mm
C: 8mm

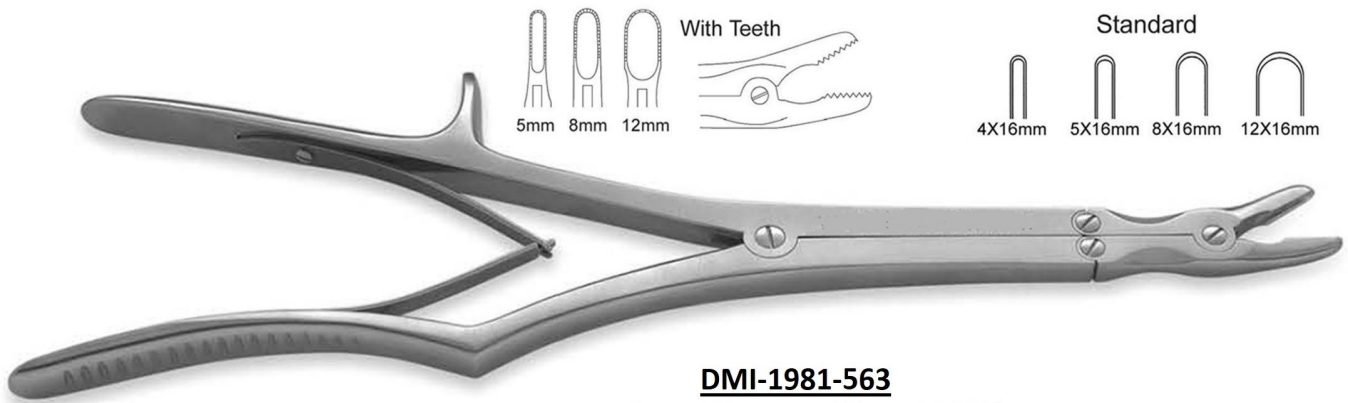

DMI-1981-563
Syfert Rongeur 37 cm / 14 1/2"

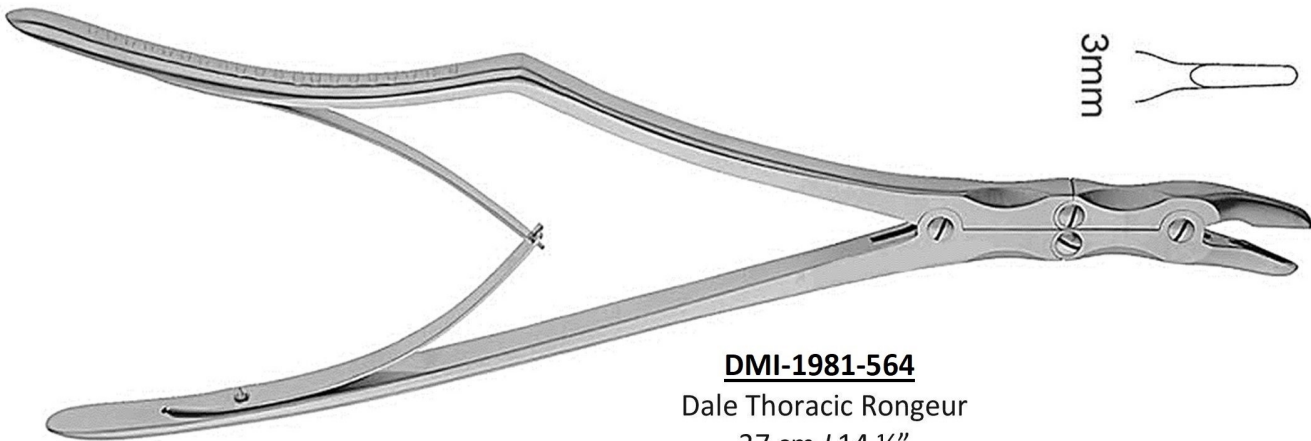

DMI-1981-564
Dale Thoracic Rongeur
37 cm / 14 1/2"

BONE RONGEURS– NIBBLERS

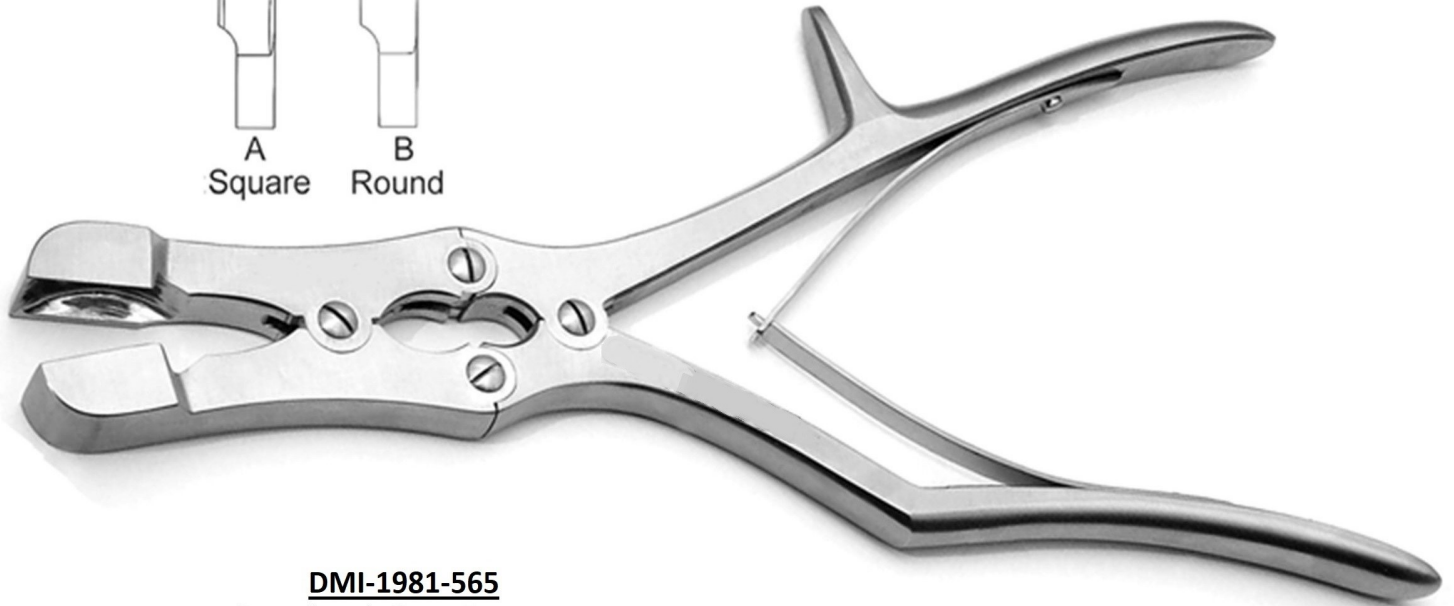
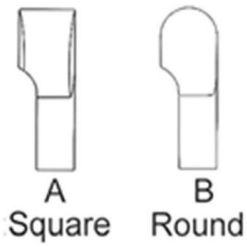

DMI-1981-565
Sauerbruch Bone Rongeur
37 cm / 14 ½"

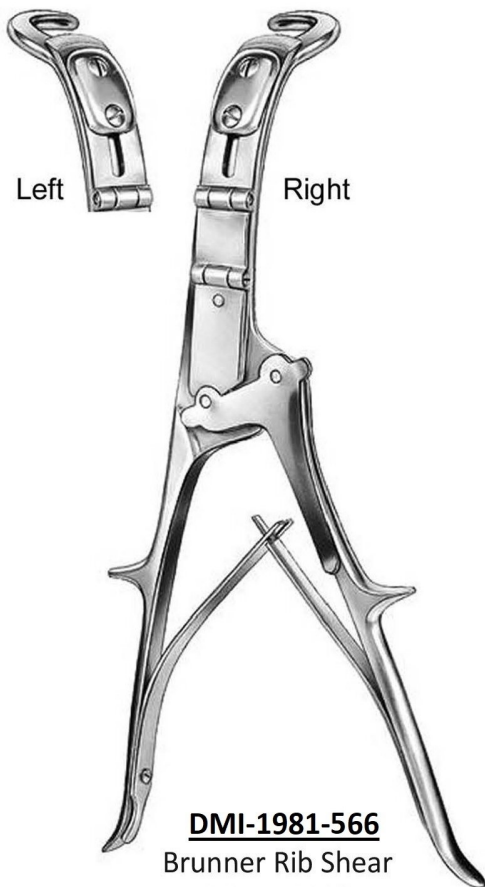

DMI-1981-566
Brunner Rib Shear
28 cm / 11"



DMI-1981-567
Sauerbruch Rib Shear
A: 23 cm / 9" | B: 26 cm / 10 ¼"

BONE RONGEURS- NIBBLERS



DMI-1981-573
Giertz Stille Rib Shear
25 cm / 10"



DMI-1981-568
Rib Shear Double Spring 22 cm / 8 ¾"

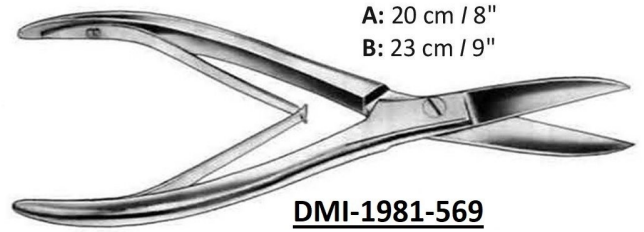

A: 20 cm / 8"
B: 23 cm / 9"
DMI-1981-569
Rib Shear Double Spring



DMI-1981-570
Collin Rib Shear 17.5 cm / 7"



DMI-1981-571
Collin Rib Shear 17 cm / 6 ¾"



DMI-1981-574
Gluck Rib Shear

- A: 16 cm / 6"
- B: 18 cm / 7"
- C: 20 cm / 8"
- D: 23 cm / 9"



DMI-1981-572
Stille Rib Shear 21 cm / 8 ¼"

RIB SHEARS

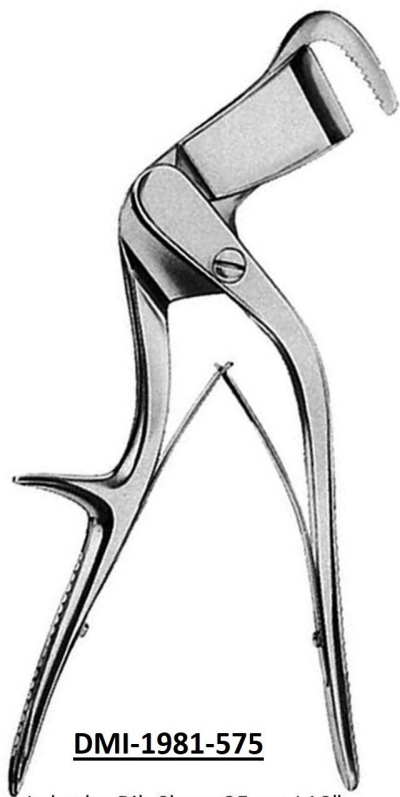

DMI-1981-575

Labsche Rib Shear 25 cm / 10"

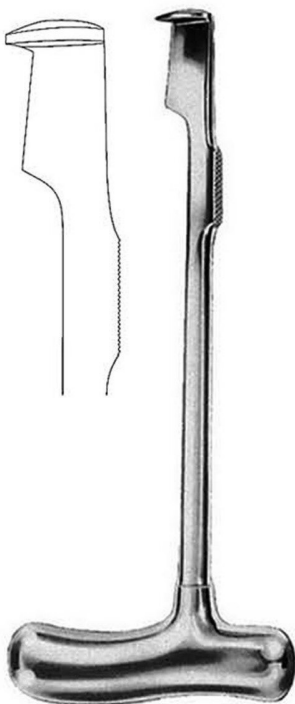

DMI-1981-576

T Handle Labsehe Sternum Chisel
24 cm / 9 1/2"



DMI-1981-577

Rib Shear Sideward 17 cm / 6 3/4"

Pointed
Tips



DMI-1981-579

Bethune Rib Shear
S Shaped Handle
34 cm / 13 1/2"



DMI-1981-578

Bethune Rib Shear
S Shaped Handle
34 cm / 13 1/2"

RIB SHEARS



DMI-1981-580
Coryllos-Bethune Rib Shear
S Shaped Handle
35 cm | 13 ½"

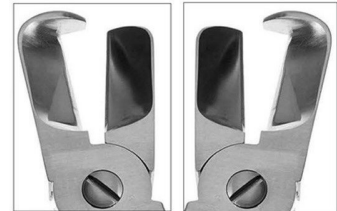

Left

Right



DMI-1981-581
Roos Rib Shear
Right Angled Jaw W/ Hook
33 cm / 13"

LAMINA SPREADERS— RETRACTORS

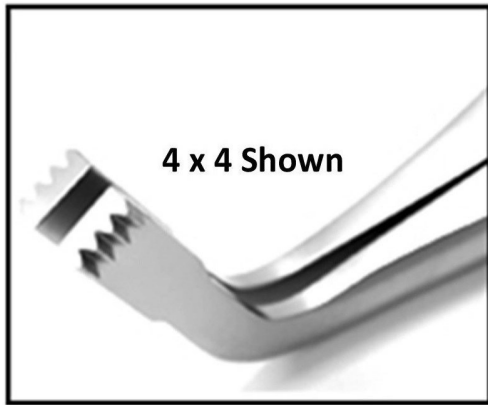

DMI-1981-582
INGE Spreader / Retractor

Available in 4X4 and 6X6 Teeth
& Without Teeth (Plain)



A: 4X4 Teeth
B: Without Teeth
16.5 cm / 6 ½"



C: 4X4 Teeth
D: Without Teeth
25.5 cm / 10"



10 Inch Length Pattern

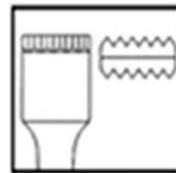

A: 6X6 Teeth
B: Without Teeth
27 cm / 10 ½"
Flat Blades



C: 6X6 Teeth
D: Without Teeth
27 cm / 10 ½"
Concave Blades



DMI-1981-583
Offset Lamina Spreader / Retractor
25.5 cm / 10"

LAMINA SPREADERS- RETRACTORS

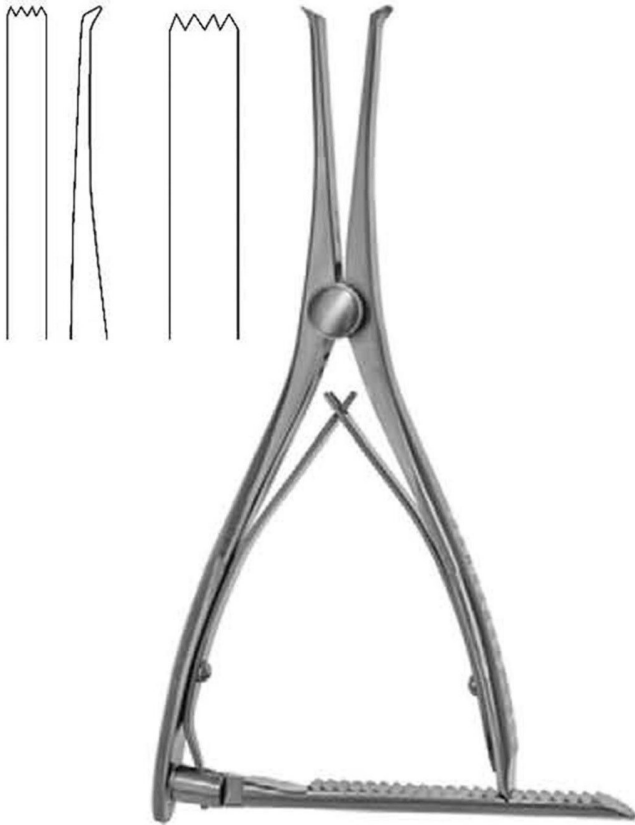

DMI-1981-584
Vertibra Spreader / Retractor
A: 18 cm / 7" | B: 28 cm / 11"



DMI-1981-585
Inge Spreader
Serrated Outside Blades 18 cm / 7"

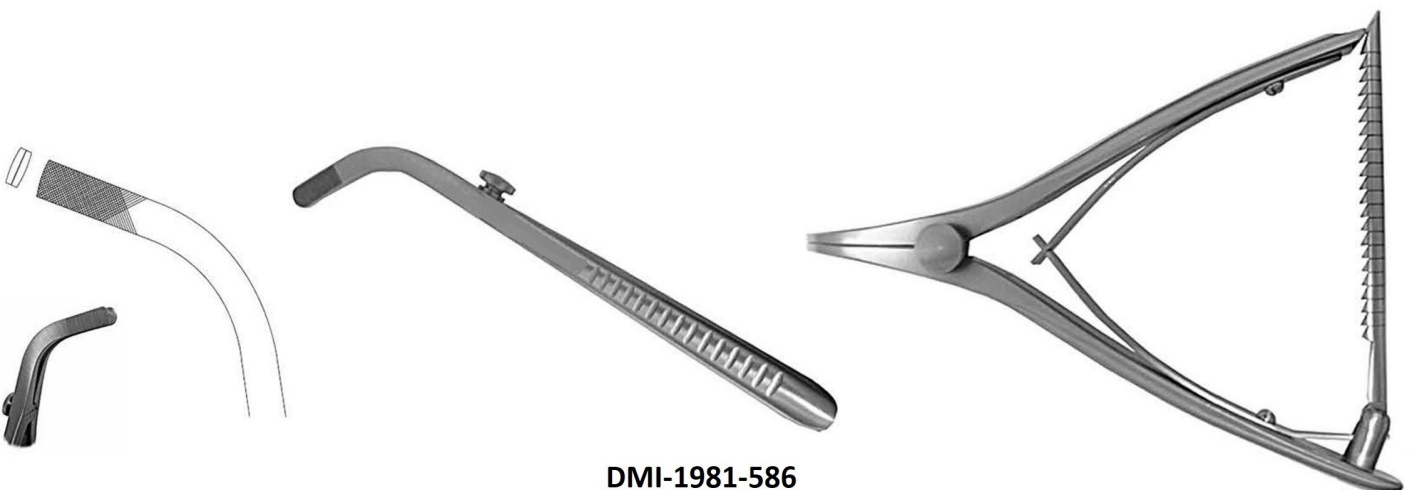

DMI-1981-586
Saxsena Lamina Spreader / Retractor
A: 18 cm / 7" | B: 25.5 cm / 10"
Serrated Outside Blades

CALCANEAL LAMBARDI SPREADERS



DMI-1981-587
Calcaneal Spreader
Smooth Pads 15X12mm
18 cm / 7"



DMI-1981-588
Calcaneal Spreader
Grooved Pads 15X12mm
18 cm / 7"



DMI-1981-588
Lombardi Femoral Tibial Spreader (Small)
A: Grooved Pads 22X13mm 18 cm / 7"
B: Diamond Cut Pads 22x13mm / 7"



B: Diamond Cut Pads 22X13mm



B: Diamond Cut Pads 22X13mm



DMI-1981-589
Lombardi Femoral Tibial Spreader (Large)
A: Grooved Pads 22X13mm 23.5 cm / 9 1/4"
B: Diamond Cut Pads 22x13mm / 9 1/4"

COMPRESSORS - DISTRACTORS



DMI-1981-590
Distracting Forceps 23 cm / 9"
Long Ratchet / Spiral Spring
For Screws and Rods



DMI-1981-591
Compressing Forceps 28 cm / 11"
Adjustable Locking
For Screws and Rods

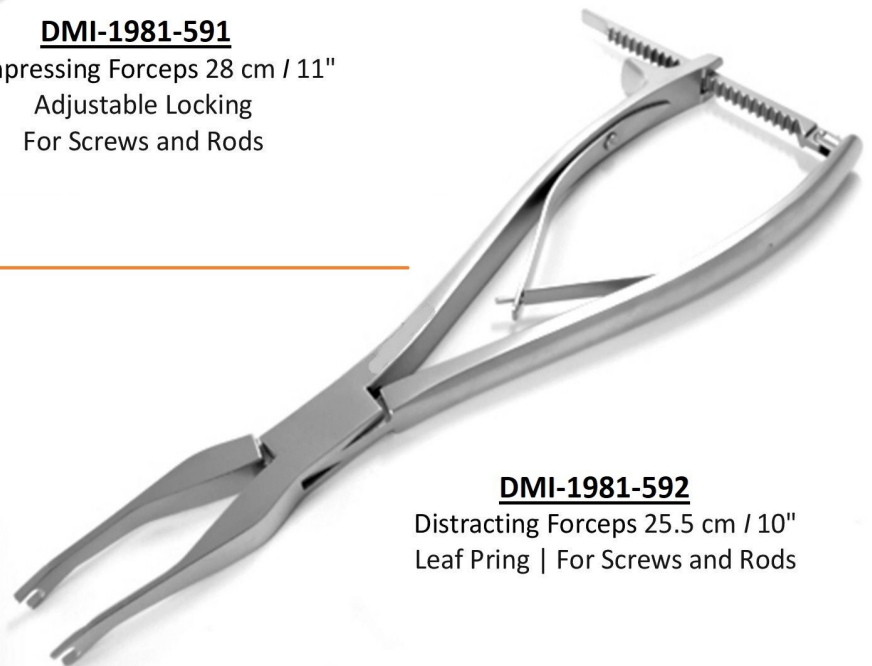

DMI-1981-592
Distracting Forceps 25.5 cm / 10"
Leaf Spring | For Screws and Rods

COMPRESSORS– DISTRACTORS



DMI-1981-593
Distractor 25.5 cm / 10"
Leaf Pring | For Screws and Rods



DMI-1981-594
Compression Forceps
28 cm / 11"
Leaf Pring / Long Ratchet
For Screws and Rods

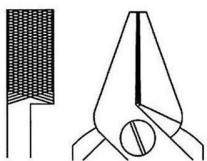

Non TC



DMI-1981-595
Jet Wire Twisting Device
28 cm / 11" - 10mm Tip

ROD BENDERS

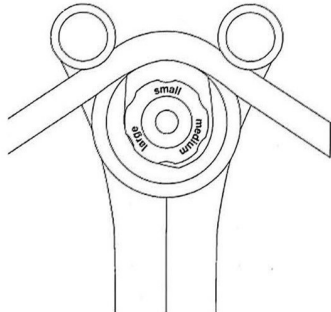

DMI-1981-596

French Style Rod Bender
28 cm / 11" | Roller Type
For Small / Medium / Large Bends

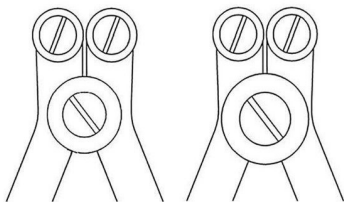

For 4mm Rod

For 3mm Rod

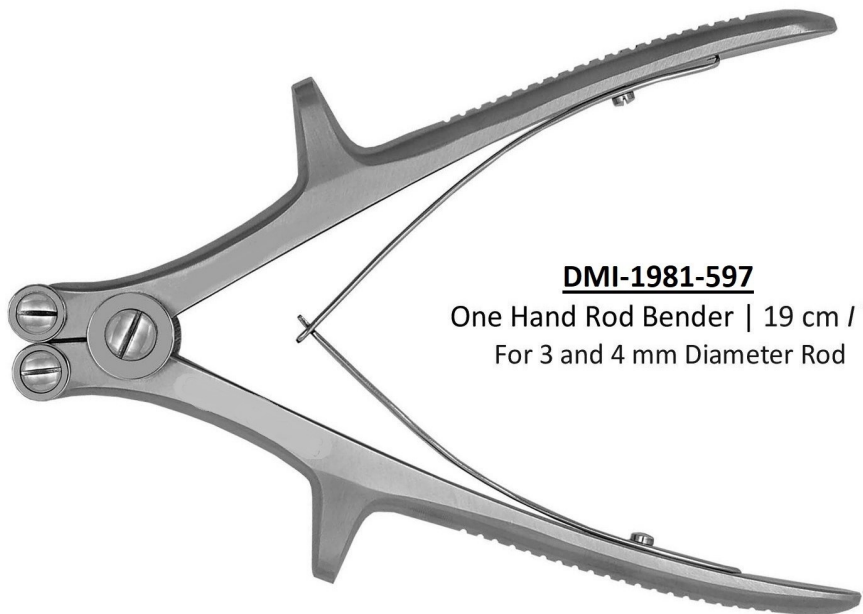

DMI-1981-597

One Hand Rod Bender | 19 cm / 7"
For 3 and 4 mm Diameter Rod

CARBIDE INSERTED WIRE- PIN CUTTING PLIERS

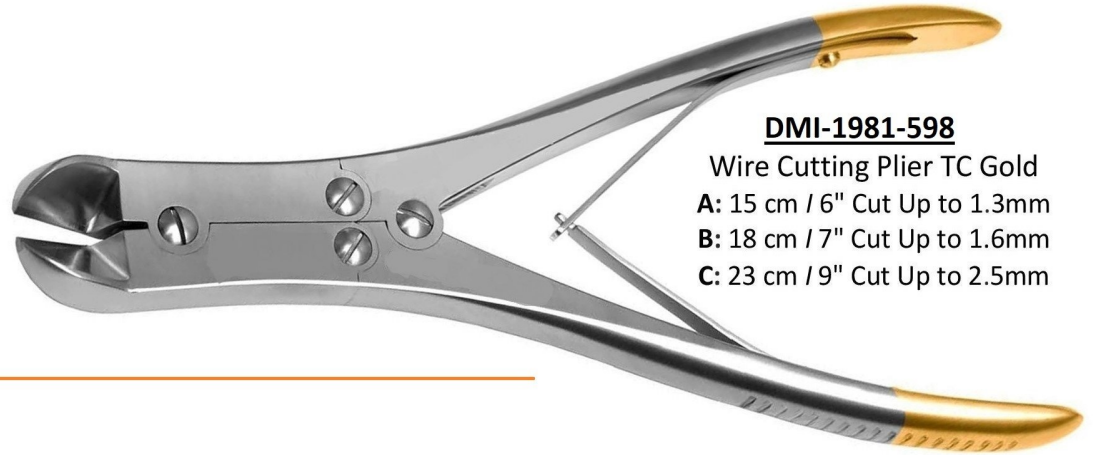
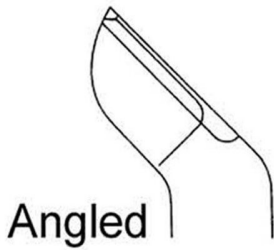

DMI-1981-598

Wire Cutting Plier TC Gold
A: 15 cm / 6" Cut Up to 1.3mm
B: 18 cm / 7" Cut Up to 1.6mm
C: 23 cm / 9" Cut Up to 2.5mm

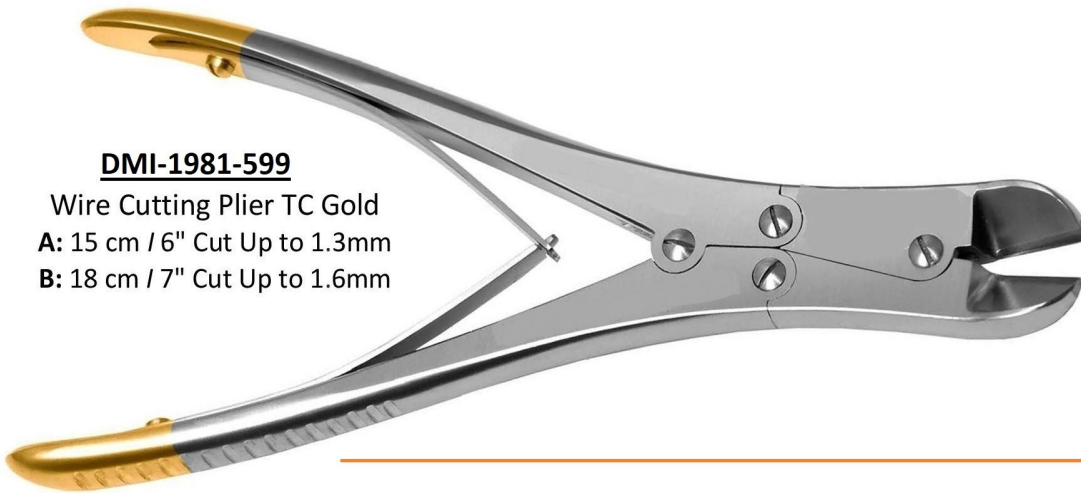

DMI-1981-599

Wire Cutting Plier TC Gold
A: 15 cm / 6" Cut Up to 1.3mm
B: 18 cm / 7" Cut Up to 1.6mm

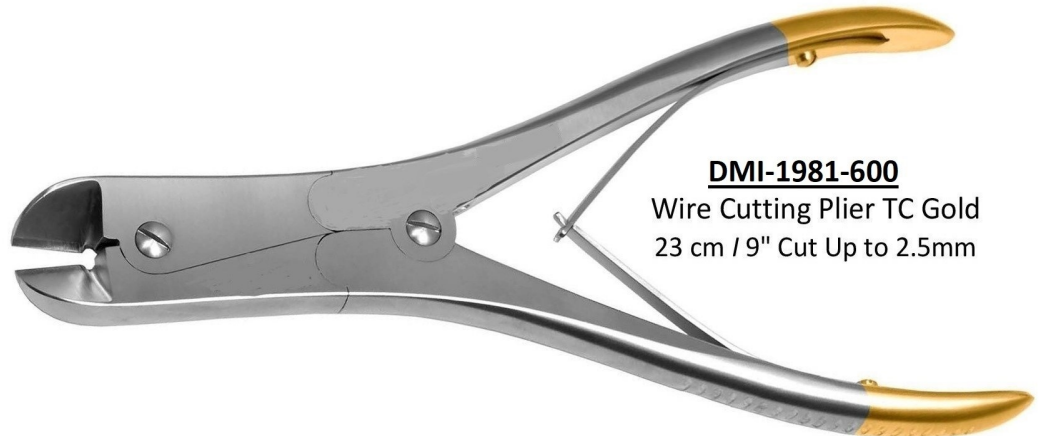

DMI-1981-600

Wire Cutting Plier TC Gold
 23 cm / 9" Cut Up to 2.5mm

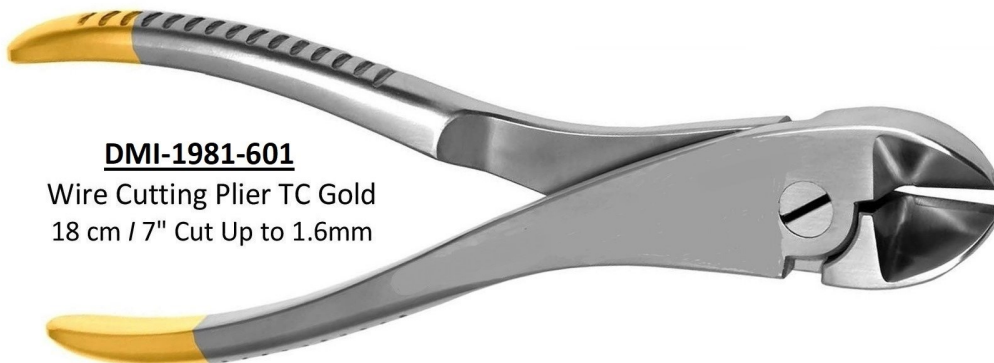

DMI-1981-601

Wire Cutting Plier TC Gold
 18 cm / 7" Cut Up to 1.6mm

CARBIDE INSERTED WIRE- PIN CUTTING PLIERS



DMI-1981-602
Cannulated Pin Cutter TC Gold
18 cm / 7" Cut Up to 1.5mm



DMI-1981-603
Front End Wire Cutting Plier
TC Gold 15 cm / 6"
Cut Up to 1.3mm



DMI-1981-604
Front End Wire Cutting Plier
TC Gold 23 cm / 9"
Cut Up to 2.5mm

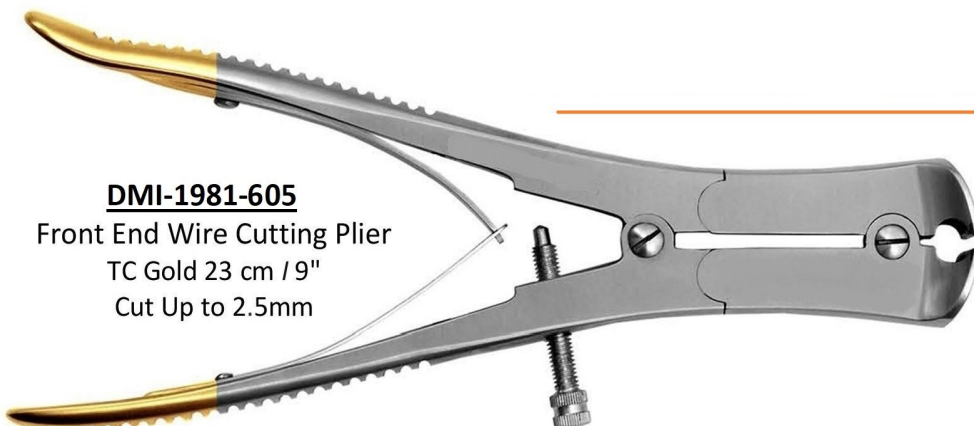

DMI-1981-605
Front End Wire Cutting Plier
TC Gold 23 cm / 9"
Cut Up to 2.5mm

CARBIDE INSERTED WIRE- PIN CUTTING PLIERS

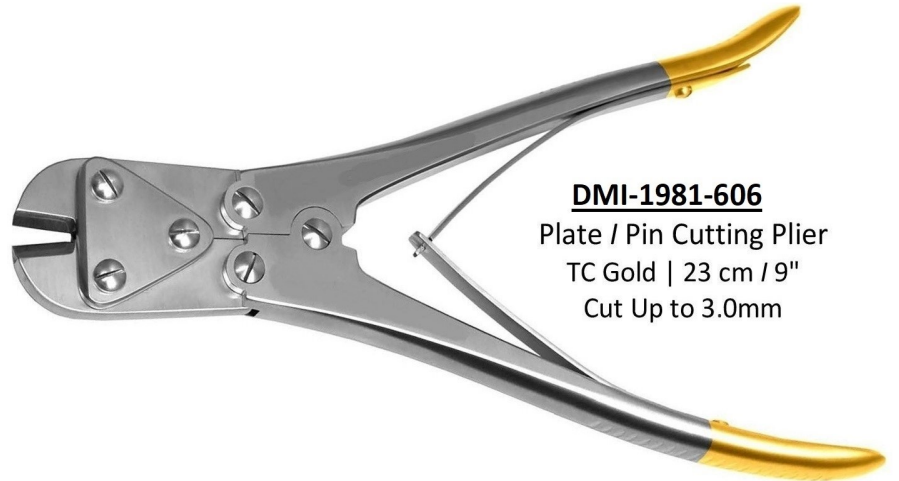

DMI-1981-606
Plate / Pin Cutting Plier
TC Gold | 23 cm / 9"
Cut Up to 3.0mm

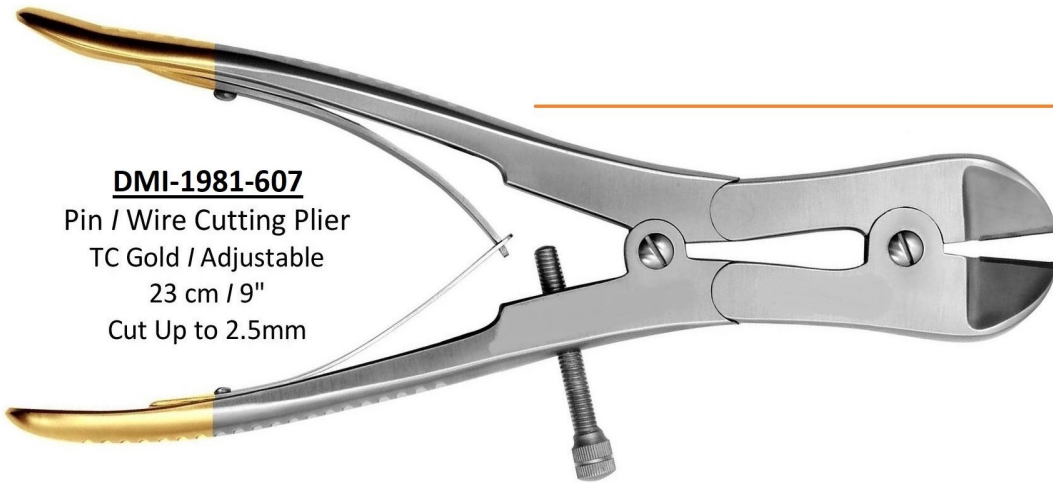

DMI-1981-607
Pin / Wire Cutting Plier
TC Gold / Adjustable
23 cm / 9"
Cut Up to 2.5mm

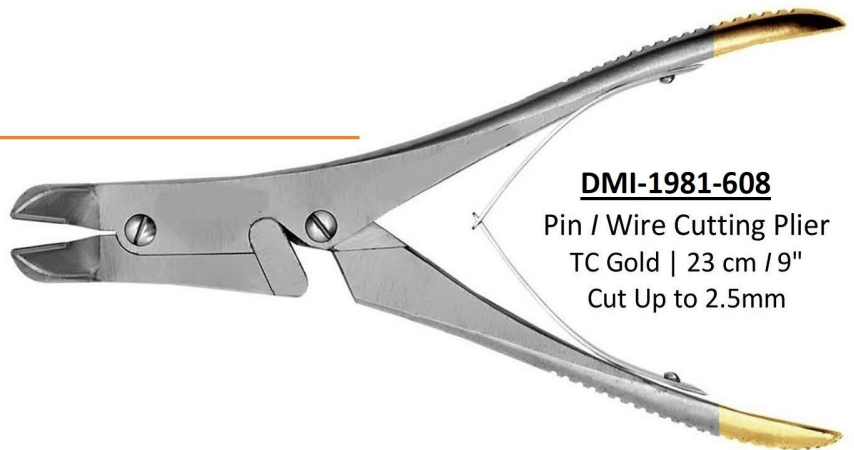

DMI-1981-608
Pin / Wire Cutting Plier
TC Gold | 23 cm / 9"
Cut Up to 2.5mm

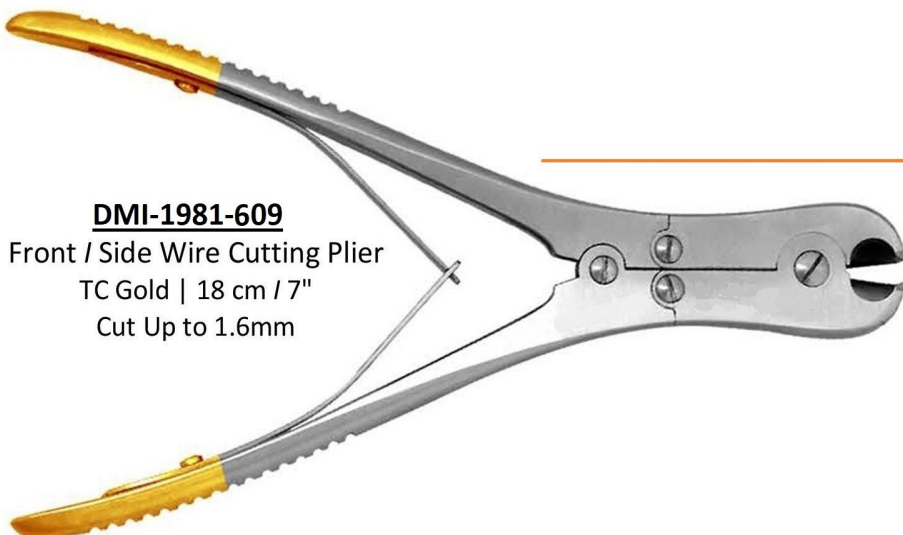

DMI-1981-609
Front / Side Wire Cutting Plier
TC Gold | 18 cm / 7"
Cut Up to 1.6mm

CARBIDE INSERTED WIRE- PIN CUTTING PLIERS

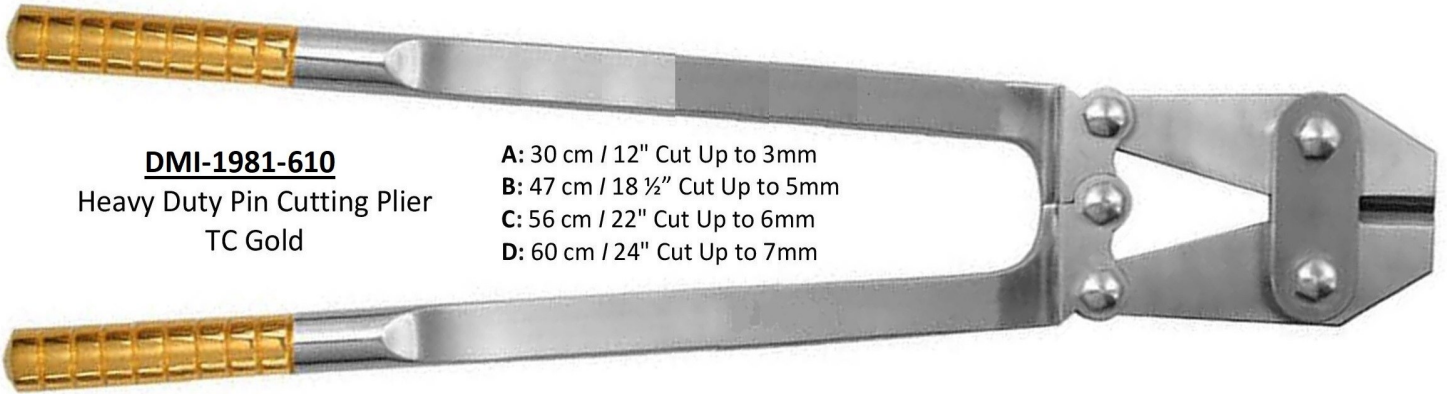

DMI-1981-610
Heavy Duty Pin Cutting Plier
TC Gold

A: 30 cm / 12" Cut Up to 3mm
B: 47 cm / 18 1/2" Cut Up to 5mm
C: 56 cm / 22" Cut Up to 6mm
D: 60 cm / 24" Cut Up to 7mm

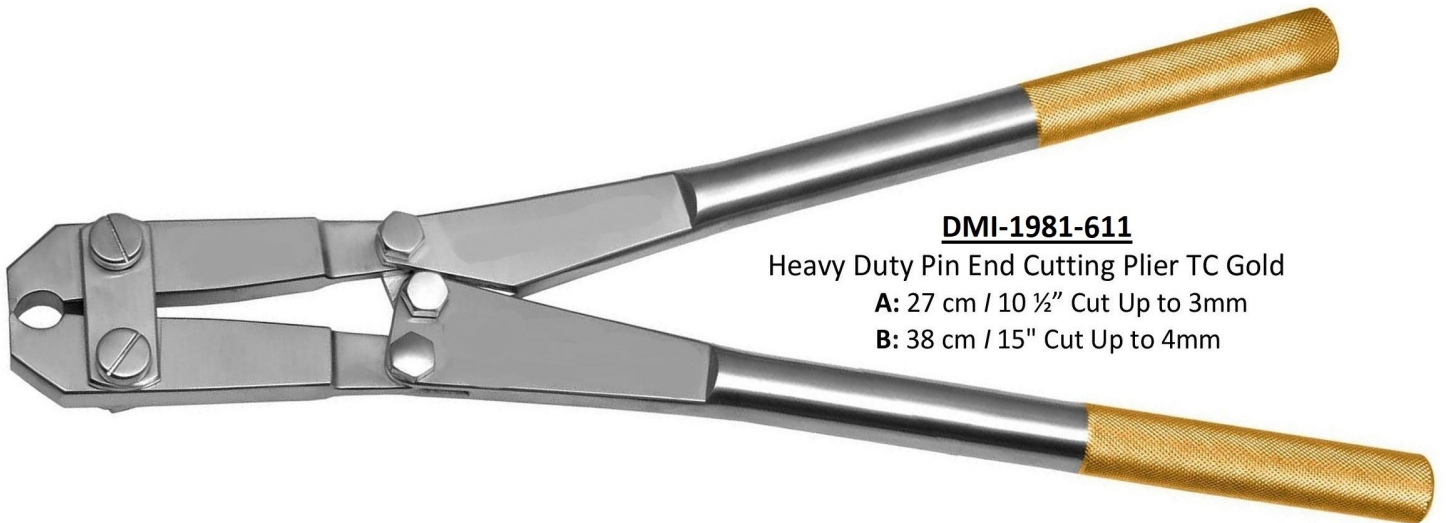

DMI-1981-611
Heavy Duty Pin End Cutting Plier TC Gold
A: 27 cm / 10 1/2" Cut Up to 3mm
B: 38 cm / 15" Cut Up to 4mm

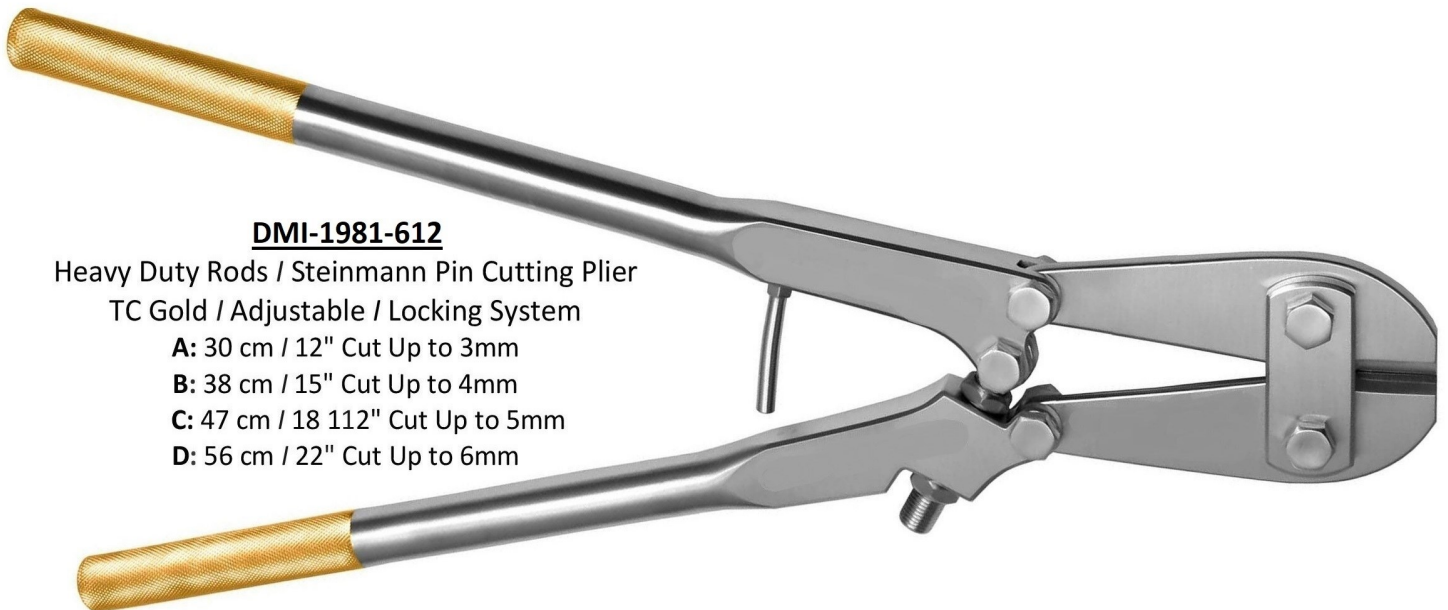

DMI-1981-612
Heavy Duty Rods / Steinmann Pin Cutting Plier
TC Gold / Adjustable / Locking System
A: 30 cm / 12" Cut Up to 3mm
B: 38 cm / 15" Cut Up to 4mm
C: 47 cm / 18 1/2" Cut Up to 5mm
D: 56 cm / 22" Cut Up to 6mm

CARBIDE INSERTED SURGICAL SCISSORS

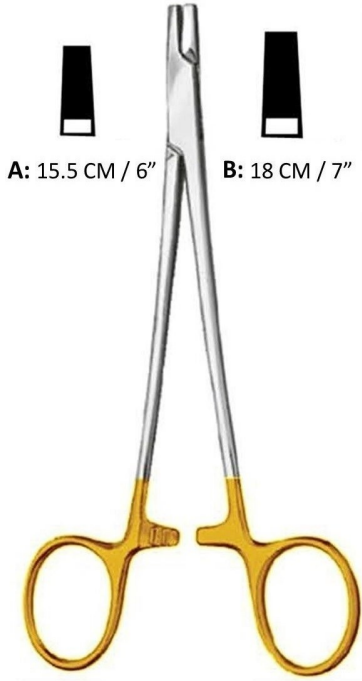

A: 15.5 CM / 6" B: 18 CM / 7"

Wire Twisting Forceps

DMI-1981-613



B: 18 CM / 7" A: 15.5 CM / 6"

Wire Twisting Forceps

DMI-1981-614



B: 20 CM / 8" A: 15.5 CM / 6"

Wire Twisting Forceps

DMI-1981-615



Corwin Combi-Wire Twisting

Forceps 18.5 cm / 7 1/4"

DMI-1981-616



Wire Twisting Forceps
15.5 cm / 6"

DMI-1981-618

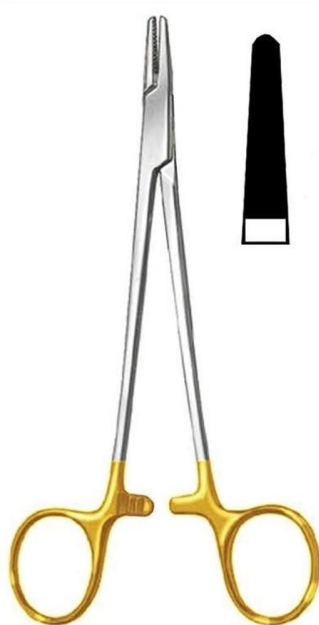

Wire Twisting Forceps
16 cm / 6 1/4"

DMI-1981-619



Wire Twisting Forceps
Heavy Pattern
19 cm / 7 1/2"

DMI-1981-620

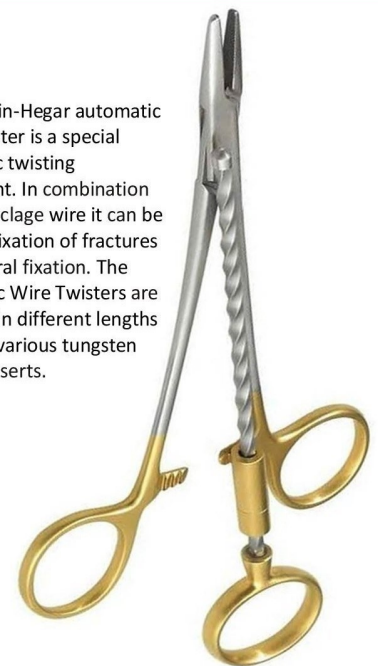

Corwin-Hegar
Auto Wire Twisting Forceps
15 cm / 6"

DMI-1981-621

The Corwin-Hegar automatic Wire Twister is a special automatic twisting Instrument. In combination with a cerclage wire it can be used for fixation of fractures or temporal fixation. The Automatic Wire Twisters are available in different lengths and with various tungsten carbide inserts.

CARBIDE INSERTED SURGICAL SCISSORS

A: 14.5 cm / 5 ¾" Str or Cvd
B: 17 cm / 6 ¾" Str or Cvd
C: 23 cm / 9" Str or Cvd

Blunt / Blunt



DMI-1981-622
Mayo Scissors TC Gold

Sharp / Sharp
Cvd or Str

Blunt / Blunt
Cvd or Str

Sharp / Blunt
Cvd or Str



DMI-1981-623
Operating (Standard) Scissors TC Gold

A: 13 cm / 5" Str. or Cvd
B: 14 cm / 5 1/2" Str. or Cvd
C: 15.5 cm / 6 1/2" Str. or Cvd
D: 18 cm / 7" Str. or Cvd

A: 14.5 cm / 5 ¾" Str. or Cvd.
B: 17 cm / 6 ¾" Str. or Cvd.
C: 23 cm / 9" Str. or Cvd.

Blunt / Blunt

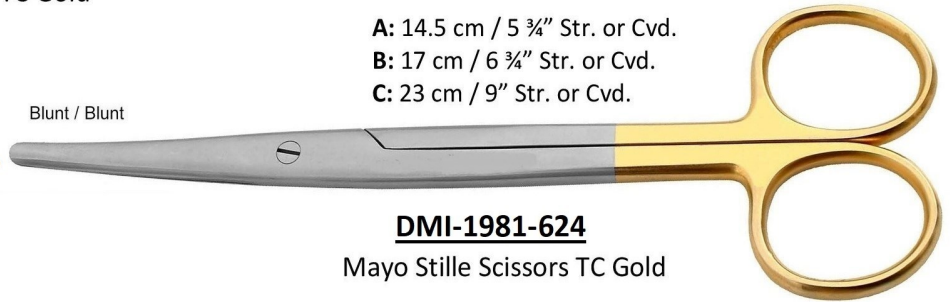

DMI-1981-624
Mayo Stille Scissors TC Gold

A: 14 cm / 5 ½" Str. or Cvd
B: 17 cm / 6 ¾" Str. or Cvd
C: 20 cm / 8" Str. or Cvd
D: 23 cm / 9" Str. or Cvd

Blunt / Blunt

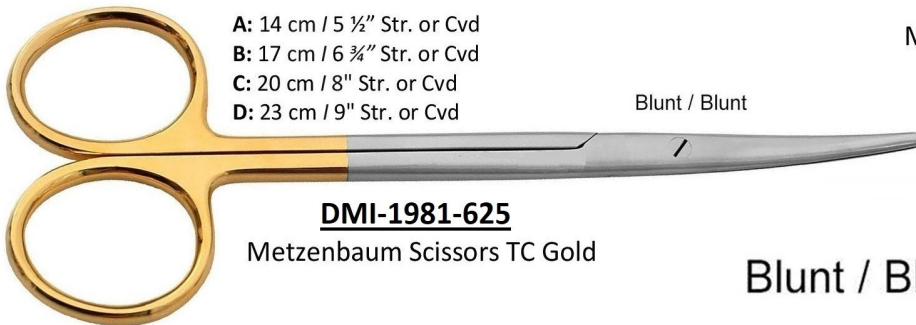

DMI-1981-625
Metzenbaum Scissors TC Gold

A: 20 cm / 8" Str. or Cvd
B: 23 cm / 9" Str. or Cvd
C: 28 cm / 11" Str. or Cvd
D: 30 cm / 12" Str. or Cvd

Blunt / Blunt



DMI-1981-626
Mayo-Harrington Scissors TC Gold

DMI-1981-627

Ortho Universal Scissors TC Gold
12 cm / 4 1/3"



DMI-1981-628

Mayo-Nobel Scissors TC Gold
16.5 cm / 6 ½" Str. or Cvd



INSTRUMENTS FOR TRUAMATOLOGY



Drill Bits for Quick Coupling

DMI-1981-630

Drill bit 1.1mm dia.
for threaded hole for 1.5mm screws
Drill bit 1.5mm dia.
For threaded hole for 2.0mm screws and gliding hole for 1.5mm
Screws
Drill bit 2.0mm dia.
For threaded hole for 2.7mm dia.
For gliding hole for 2.7mm screws

<u>Item</u>	<u>Diameter</u>	<u>Total length</u>	<u>Usable length</u>
	1.1mm	060mm	035mm
	1.5mm	085mm	060mm
	1.5mm	110mm	085mm
	2.0mm	100mm	145mm
	2.0mm	125mm	100mm
	2.7mm	100mm	075mm
	2.7mm	125mm	100mm
	2.7mm	100mm	075mm
	2.0mm	125mm	100mm

DMI-1981-631

Drill bit 2.5mm dia.
For threaded hole for 3.5 and 4.0mm screws
Drill bit 3.5mm
for gliding hole for 3.5mm screws

<u>Item</u>	<u>Diameter</u>	<u>Total length</u>	<u>Usable length</u>
	2.5mm	110mm	085mm
	2.5mm	180mm	155mm
	3.5mm	100mm	085mm
	3.5mm	195mm	170mm

DMI-1981-632

Drill bit 3.2mm dia.
For threaded hole for 4.5 and 6.5mm screws
Drill bit 4.5mm dia.
For gliding hole for 4.5mm screws

<u>Item</u>	<u>Diameter</u>	<u>Total length</u>	<u>Usable length</u>
	2.0mm	100mm	145mm
	3.2mm	225mm	200mm
	3.2mm	145mm	120mm
	3.2mm	195mm	170mm
	4.5mm	145mm	120mm
	4.5mm	195mm	170mm



DMI-1981-629

Drill Bit for Jacobs chuck

<u>Item</u>	<u>Diameter</u>	<u>Total length</u>	<u>Usable length</u>
	1.1mm	45mm	30mm
	1.5mm	70mm	55mm
	2.0mm	85mm	70mm
	2.5mm	95mm	80mm
	2.7mm	85mm	70mm
	3.2mm	130mm	115mm
	3.2mm	180mm	165mm
	3.5mm	95mm	80mm
	3.5mm	180mm	165mm
	4.5mm	130mm	115mm
	4.5mm	180mm	165mm



DMI-1981-634

Tap for 1.5mm Cortex Screws
Total length 50mm, thread length 20mm
predrilling 1.1mm dia.



DMI-1981-635

Tap for 6.5mm Cancellous Bone Screws
Length 195mm, predrilling 3.2mm dia.



DMI-1981-636

Tap for 4.0mm Cancellous Bone Screws
Total Length 110mm, Usable Length 85mm

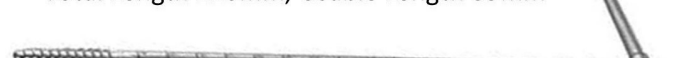

DMI-1981-637

Tap Cannulated, for 7.0mm Cannulated Screws
Length 230mm



INSTRUMENTS FOR TRUAMATOLOGY



DMI-1981-639

Tap for 2.0mm Cortex Screws
Predrilling: 1.5mm dia.

<u>Item</u>	<u>Thread</u>	<u>length</u>
	24mm	053mm
	38mm	100mm

DMI-1981-640

Tap for 2.7mm Cortex Screws
Predrilling: 2.0mm dia.

<u>Item</u>	<u>Thread length</u>	<u>Total length</u>
	33mm	100mm
	40mm	150mm

DMI-1981-638

Tap for 3.5mm Cortex Screws
Predrilling: 2.5mm dia.

<u>Item</u>	<u>Total length</u>	<u>Type</u>
	175mm	with length markings
	110mm	thread length 50mm

Predrilling: 3.2mm

<u>Item</u>	<u>Length</u>	<u>Type</u>
	125mm	thread length 70mm
	175mm	with length markings

DMI-1981-641

Tap for 3.5mm Cortex Screws
Total Length: 110mm
Thread Length: 50mm
Predrilling: 3.2mm dia.

DMI-1981-642

Tap for 2.7mm Cortex Screws
Total length: 125mm
Thread length: 40mm
Predrilling: 2.0mm dia.

DMI-1981-643

Tap for 4.5mm Cortex Screws
Total length: 125mm
Thread length: 70mm
Predrilling: 3.2mm dia.



DMI-1981-644

Countersink Shaft 1.5/2.0
Length 52mm, for mini quick coupling



DMI-1981-645

Router, for Jacobs chuck
Length 90mm



DMI-1981-646

Router, for quick coupling
Length 90mm



DMI-1981-647

Countersink Shaft 3.5mm
Length 72mm, for quick coupling,
to countersink the screw head

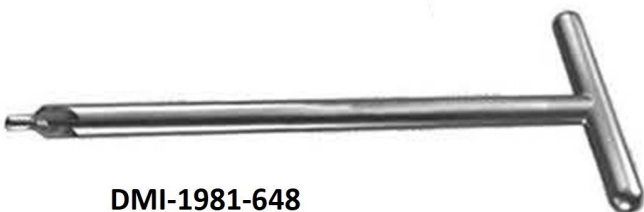

DMI-1981-648

Countersink, large
Length 180mm, for 4.5mm cortex screws



DMI-1981-649

Countersink, cannulated, for 7.0mm cannulated Screws
Length 230mm

INSTRUMENTS FOR TRUAMATOLOGY



DMI-1981-650

Screwdriver Shaft, hexagonal, small
Length 100mm, for quick coupling
For 2.7 to 4.0mm screws.



DMI-1981-651

Screwdriver Shaft, Hexagonal, large
Length 100mm, final tightening of the screw has to
be done by hand.



DMI-1981-652

Screwdriver Shaft, hexagonal, with Holding Sleeve
For 1.5 and 2.0mm stainless steel screws
With hexagonal socket,



DMI-1981-653

Screwdriver Shaft, cruciform, 1.5/ 2.0, with Holding Sleeve
Length 50mm, for 1.5 and 2.0mm



DMI-1981-654

T-Handle with Coupling
Length: 80mm, for taps



DMI-1981-655

Screwdriver, hexagonal, with T-Handle,
Large to loosen tight screws.
A normal screwdriver can be
additionally inserted in the hollow
shaft of the T-handle.



DMI-1981-656

Handle with mini quick coupling



DMI-1981-657

Hand Chuck for Kirschner Wires
Length 145mm, Spannbereich 0.6 to 1.6mm dia.



DMI-1981-658

Handle with quick coupling
Length 110mm, for countersinks and
Instruments for the removal of damaged screws



DMI-1981-659

Handle, small, with mini quick coupling

INSTRUMENTS FOR TRUAMATOLOGY



DMI-1981-660

Handle, medium, with mini quick coupling



DMI-1981-661

Handle, Large, with mini quick coupling



DMI-1981-662

Screwdriver, hexagonal, small with groove
Length 200mm, for 2.7 to 4.0mm screws



DMI-1981-663

Screwdriver with Universal Joint, large
Length 290mm



DMI-1981-664

Screwdriver, hexagonal, large, with groove
Length 240mm



DMI-1981-665

Screwdriver, hexagonal, with Holding Sleeve,
Length 165mm for 1.5 and 2.0mm stainless
Steel screws with hexagonal socket



DMI-1981-666

Screwdriver, hexagonal, small, with Holding Sleeve
Length 200mm



DMI-1981-667

Holding Sleeve for Mini Screws single



DMI-1981-668

Holding Sleeve



DMI-1981-669

Holding Sleeve single



DMI-1981-670

Allen Key, hexagonal, angled
For 4.5 to 7.0mm screws



DMI-1981-671

Allen Key, hexagonal, small, angled
Length 65mm, for 2.7 to 4.0mm screws

INSTRUMENTS FOR TRUAMATOLOGY



DMI-1981-672

Insert Drill Sleeve 3.5/2.5
Length 42mm, drill bit 2.5mm dia.



DMI-1981-674

Trocar 2.0mm dia., Length 118mm, for percutaneous insertion of 7.0mm cannulated screws



DMI-1981-676

Drill Sleeve 4.5/ 2.0
Length 109mm, for percutaneous insertion of 7.0mm cannulated screws



DMI-1981-678

Handle for Drill Guides single

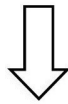

DMI-1981-680

Drill Sleeve 3.0 with point length 55mm



DMI-1981-673

Insert Drill Sleeve 4.5/3.2
Length 80mm for long lag screws



DMI-1981-675

Drill Sleeve 8.0/4.5
Length 100mm, for percutaneous insertion of 7.0mm cannulated screws



DMI-1981-677

Handle for Drill Guides single

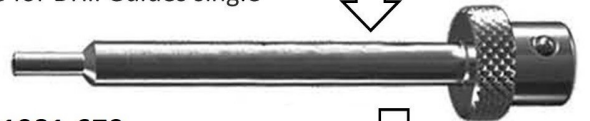

DMI-1981-679

Drill Sleeve 1.5mm / 2.0 / 2.7mm

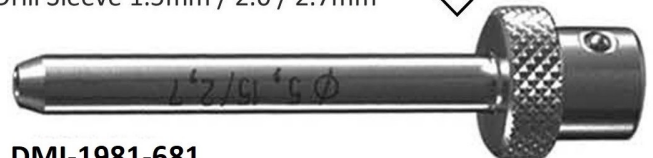

DMI-1981-681

Drill Sleeve 2.7



DMI-1981-682

Double Drill Sleeve 1.5/101
For 1.5mm cortex screws
Drill bits, 1.5 and 1.1mm dia.



DMI-1981-683

Double Drill Sleeve 2.0/1.5 for
2.7mm cortex screw



DMI-1981-684

Double Drill Sleeve 2.7/2.0
For 2.7mm cortex screws



DMI-1981-685

Double Drill Sleeve 3.5/2.5
For 3.5mm cortex screws and 4.0mm cancellous bone screws
Drill bits 3.5 and 2.5 dia.,

INSTRUMENTS FOR TRUAMATOLOGY



DMI-1981-686
Double Drill Sleeve 4.5/3.2
For 4.5mm cortex screws
Drill bits: 4.5 and 3.2mm dia.



DMI-1981-687
Double Drill Sleeve 6.5/3.2
For 6.5mm cancellous bone screws
Drill bit: 3.2mm dia.



DMI-1981-688
Universal Drill Sleeve 2.7
Drill bits 2.0 and 2.7mm dia.,
Suitable for LC-DCP and round hole plates.



DMI-1981-689
Universal Drill Guide 3.5
Drill bit 2.5 and 3.5mm dia., and tissue protection
Suitable for LC-DCP and round hole plates.



DMI-1981-690
Universal Drill Guide 4.5/3.2
Drill bits 3.2 and 4.5mm dia.



DMI-1981-691
DCP Drill Guide 2.0
For neutral and load position
Drill bit 1.5mm dia.



DMI-1981-692
DCP Drill Guide 2.7
For neutral and load position
Drill bit 2.0mm dia.



DMI-1981-693
DCP Drill Guide 3.5
For neutral a load position, drill bit 2.5m dia.



DMI-1981-694
DCP Drill Guide 4.5
For neutral and load position, drill bit 3.2mm dia.



DMI-1981-695
LC-DCP Drill Guide 3.5
For neutral a load position, drill bit 2.5mm dia.



DMI-1981-696
LC-DCP Drill Guide 4.5
For neutral and load position, drill bit 3.2mm dia.



DMI-1981-697
DCP Hip Drill Guide 4.5, for neutral and load position, for 4.5mm screws with DHS and angled blade plates, sleeve length 60mm, drill bit 3.2mm dia.

INSTRUMENTS FOR TRUAMATOLOGY



DMI-1981-698

Triple Drill Sleeve 2.0
with 3 holes, opposite side 1 hole



DMI-1981-699

DCP Mandible Drill Guide 2.7 short
drill bit 2.0mm dia.



DMI-1981-700

DCP Mandible Drill Guide 2.7 long
drill bit 2.0mm dia.



DMI-1981-701

Insert Drill Sleeve with stop, for 4.5mm screws
adjustable length to limit drilling depth,
external dia. 4.5mm for drill bits of 3.2mm dia.



DMI-1981-702

Parallel drill Guide 4.5
For percutaneous insertion of 7.0mm cannulated screws



DMI-1981-703

Parallel Wire Guide 2.0mm dia.



DMI-1981-704

Depth Gauge for 2.7 to 4.0mm screws
measuring range up to 60mm



DMI-1981-705

Depth Gauge for 2.7 to 4.0mm screws measuring
range up to 60mm



DMI-1981-707

Depth Gauge for 4.5mm to 6.5mm screws measuring
range up to 110mm



DMI-1981-706

Bending Iron for plates 2.7 and 3.5
Length 150mm, slid widths 2.5 and 4.5mm, required paris
Slid placement: 4.5 / 2.5
Slid placement: 2.5/4.5



DMI-1981-708

Bending Iron for plates 1.5 and 2.5
Length: 130mm, slid width: 2.5mm

INSTRUMENTS FOR TRUAMATOLOGY

DMI-1981-709

Triple Drill Guide

130° angle, for 130° angled blade plates and for condylar plates, drill bit 4.5mm dia.



DMI-1981-710

Drill Guide with stop 3.5/2.7 to limit drilling depth



DMI-1981-712

Protection Sleeve 11.0/8.0 for percutaneous insertion of 7.0mm cannulated screws



DMI-1981-711

Holding Sleeve
Length 80mm, for 2.7 to 4.0mm screws



DMI-1981-713

Holding Sleeve for length 80mm for 2.7mm screws and 3.5mm cannulated screws



DMI-1981-715

Screw Forceps, self-holding
Length 85mm, to take screws out of the screw racks



DMI-1981-714

Holding Sleeve, large, length 120mm



DMI-1981-716

Drill Sleeve, pointed



DMI-1981-717

Bending Iron LC-DCP/DCP
Length 250mm, for small and broad LC-DCP, DCP
Slit widths 5 and 7mm, required in pairs

INSTRUMENTS FOR TRUAMATOLOGY



DMI-1981-718 Bending Iron for Kirschner Wires
Length 120mm, for 1.25 to 2.5mm dia.



DMI-1981-719 Bending Iron for Kirschner Wires
Length 115mm, for 0.8 to 1.25mm dia.



DMI-1981-720
Bending Iron for Reconstruction Plates 3.5 and 4.5
Length 190mm, required in paris



DMI-1981-721
Handle with Sleeve
with rotating drill guide and anchoring point



DMI-1981-722
Trocar Point, large



DMI-1981-723
Combination Wrench 11mm length 140mm



DMI-1981-724
Cheek Retractor Ring



DMI-1981-725
Pin Wrench, length 120mm, 4.5mm dia.
For tension device, distractor and knurled
nut of insertion handle for intramedullary nail



DMI-1981-726
Socket Wrench 11mm
Length 200mm



DMI-1981-727
Slotted Hammer
Length 270mm



DMI-1981-728
Inserter/Extractor, with Adjustable Clamps, length 270mm, for the
insertion and extraction of angled plates for adults and hip plates for
adolescents and children as well as tibial plateau osteotomy plates.



DMI-1981-729
Measuring Device
For drill bits, screws, Kirschner wires,
and Steinmann pins

INSTRUMENTS FOR TRUAMATOLOGY

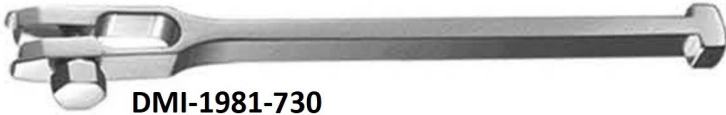

DMI-1981-730

Inserter/Extractor

Length 175mm, for infant hip plate and mini hip plate.



DMI-1981-731

Bending Pliers for Reconstruction Plates 2.7 and 3.5
Length 240mm



DMI-1981-732

Bending Pliers for plate 2.4 to 4.0
Length 230mm



DMI-1981-733

Cutter for thin plates 1.5 to 2.7
Length 256mm



DMI-1981-734

Bending Pliers
For reconstruction plates 2.7,
Length 270mm, required in paris



DMI-1981-735

Cerclage Wire Tightener
Length 260mm
For twisting, for temporary fixation during reduction



DMI-1981-736

Bending Pliers for Plates

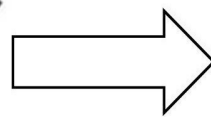

DMI-1981-737

Anvil, narrow



DMI-1981-738

Anvil, Large

INSTRUMENTS FOR TRUAMATOLOGY

DMI-1981-739

Bending Press
Length 400mm



DMI-1981-740

Tension Device, articulated
Span 20mm, can also be used as a distractor.
Color scale: yellow up to 500N, green up to 1000N,
red above 100N.



DMI-1981-741

Chisel Guide
With adjustable angle



DMI-1981-742

Blade with foot single

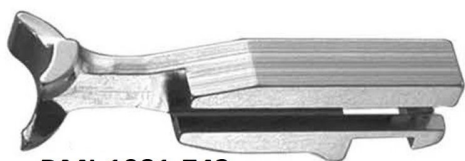

Blade with tip single

DMI-1981-743

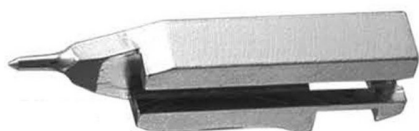

DMI-1981-744

Forceps with Sliding Blades
Complete with two interchangeable blades
Length 155mm, weight 42 g, speed lock



DMI-1981-745

Wire Passer 45mm bending diameter



DMI-1981-756

Wire Passer 70mm bending diameter



DMI-1981-757

Holding Clip



Wire Tightener

DMI-1981-758

Length 240mm, with handle and two pegs



INSTRUMENTS FOR TRUAMATOLOGY



DMI-1981-759

Handle with quick coupling
Length 150 mm



DMI-1981-761

Cancellous Bone Impactor, curved, 6mm dia.
Flattened, Length 140 mm



DMI-1981-763

Cancellous Bone Impactor, rectangular,
6x16mm, Length 140 mm



DMI-1981-765

Cancellous Bone Impactor, rectangular,
10x30mm, Length 140 mm



DMI-1981-767

Rasp, half-round
Length: 140 mm



DMI-1981-769

Gouge, curved, 5mm wide
Length 140 mm



DMI-1981-771

Gouge, curved, 10 mm wide
Length 140 mm



DMI-1981-760

Cancellous Bone Impactor, curved, 6mm dia.
Length 140 mm



DMI-1981-762

Cancellous Bone Impactor, straight, 8 mm dia.
Length 140 mm



DMI-1981-764

Cancellous Bone Impactor, rectangular,
10x20mm, Length 140mm



DMI-1981-766

Rasp round
Length: 140 mm



DMI-1981-768

Gouge, straight, 5mm wide
Length 140 mm



DMI-1981-770

Gouge, straight, 10 mm wide
Length 140mm



DMI-1981-772

Gouge, curved, 15 mm wide
Length 140 mm

INSTRUMENTS FOR TRUAMATOLOGY



Gouge, straight, 15 mm wide
Length 140 mm

DMI-1981-773



Chisel, flat, curved, 16 mm wide
Length 140 mm

DMI-1981-774



Chisel, flat, straight, 16 mm wide
Length 140 mm

DMI-1981-775



Chisel, flat, curved, 4 mm wide
Length 140 mm

DMI-1981-776



Chisel, flat, 20 mm wide
Length 140 mm

DMI-1981-777



Chisel, flat, curved, 8 mm wide
Length 140 mm

DMI-1981-778



DEMAANZ INDUSTRIES

Roras road,
Sialkot, Pakistan.

Phone: +92-300 612 6898

Fax: +92-523-55 8686

Email: info@demaanz.com



Organization

HEAD OFFICE
Shad Colony, Roras Road,
Sialkot 51310 - Pakistan

Cell: +92-300-6126898
Ph: +92-52-3558636
Fax: +92-52-3558636

info@demaanz.com
www.demaanz.com

